

Make Up Cart

Assembly Instructions

Please keep for future reference

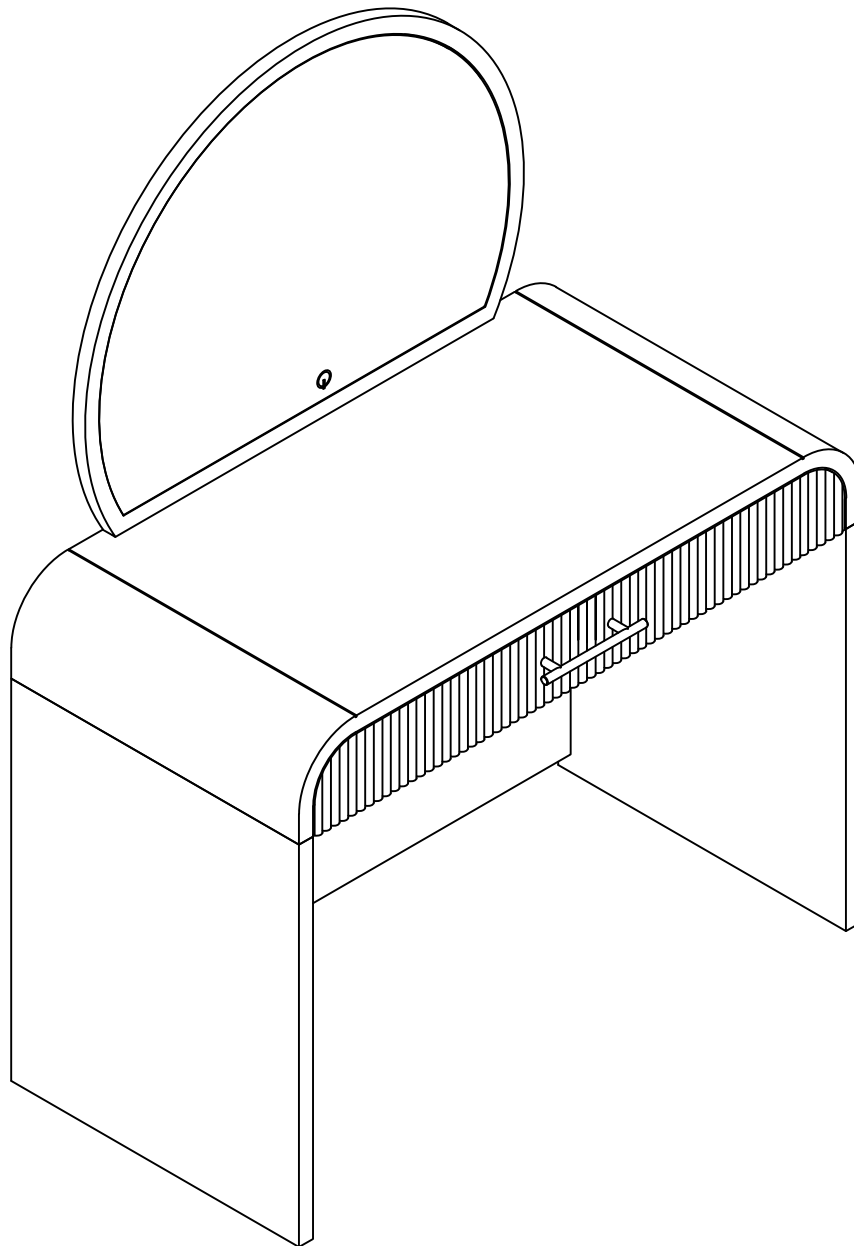

Important - Please read these instructions fully before starting assembly

Safety and Care Advice

Important – Please read these instructions fully before starting assembly

- Check you have all the components and tools listed on the following pages.
- Remove all fittings from the plastic bags and separate them into their groups.
- Keep children and animals away from the work area, small parts could choke if swallowed.
- Make sure you have enough space to layout the parts before starting.

- During assembly do not stand or put weight on the product, this could cause damage.
- Assemble the item as close to its final position (in the same room) as possible.
- Assemble on a soft level surface to avoid damaging the unit or your floor.
- Parts of the assembly will be easier with 2 people.



- To reduce the likelihood of damaging your product please ensure that your power drill is set on a low torque setting.

• Only clean using a damp cloth and mild detergent, do not use bleach or abrasive cleaners.

• From time to time check that there are no loose screws on this unit.

• This product should not be discarded with household waste. Take to your local authority waste disposal centre.

• Assemble all parts and bolts loosely during assembly, only once the product is complete should you fully tighten the bolts

• Regularly check and ensure That all bolts and fittings are tightened properly.

WARNING In order to help prevent overturning – please follow these instructions

To help prevent product toppling over please follow the below steps:-

Use the anti tip stop or wall fixing method provided (if applicable)
Do not allow children to climb or hang on the furniture
Do not open more than one drawer at a time
Do not place heavy items in the top drawers
Do not place heavy items on top of the furniture, unless the furniture has been designed for this purpose

Using Camlocks

Step 1

Connect the male camlock as directed in the assembly instructions using a screwdriver.

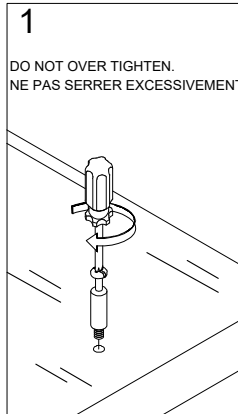

Step 2

Push the male camlock into the entry hole.

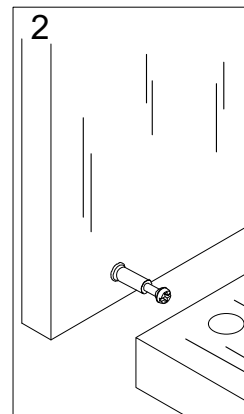

Step 3

Insert the female camlock as shown in the instruction.

Note: ensure that the arrow on the top of the camlock points towards the entry hole for the male camlock.

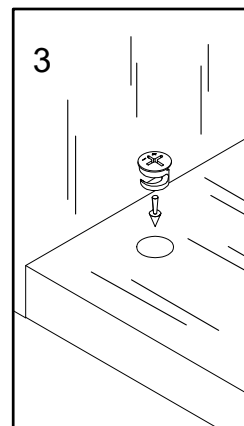

Step 4

Turn the female camlock clockwise with a screwdriver.

You should feel a click when the camlock is locked in place.

The joint is now secure.

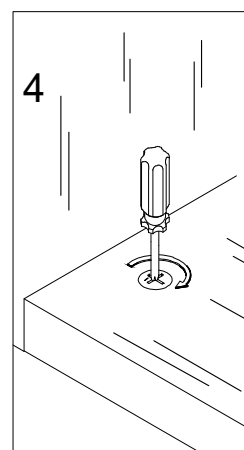

COMPONENTS - KEY DIAGRAM

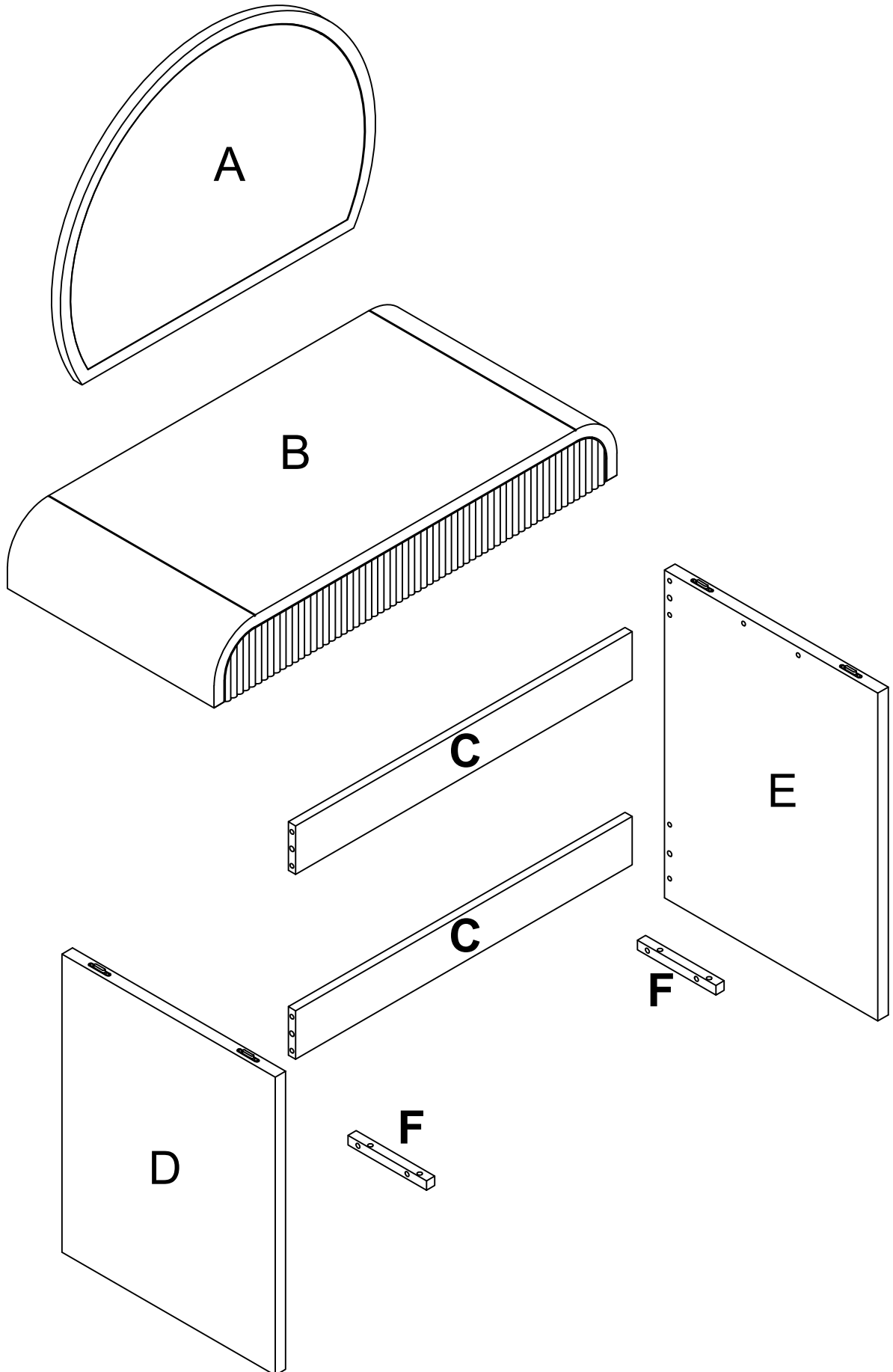

PART LIST

A

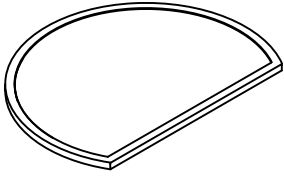

MIRROR FRAME

QTY:1

B

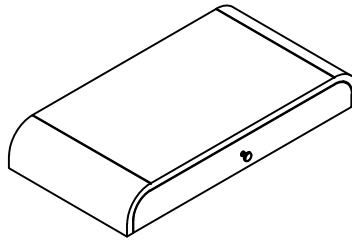

DESK TOP

QTY:1

C

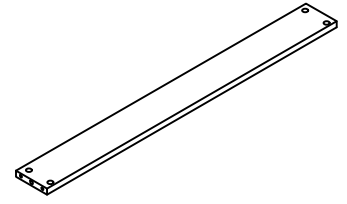

BACK PANEL

QTY:2

D

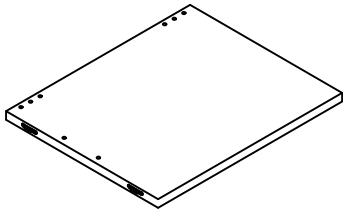

LEFT SIDE PANEL

QTY:1

E

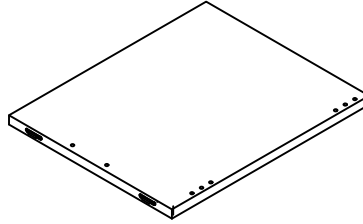

RIGHT SIDE PANEL

QTY:1

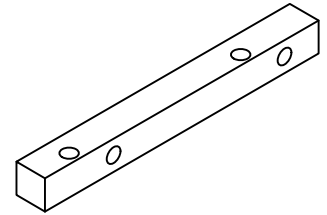

F



CONNECT WOOD

QTY:2

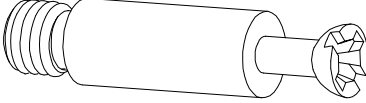
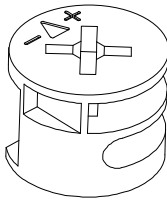
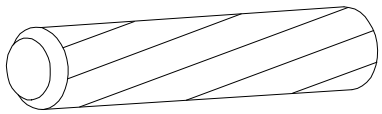
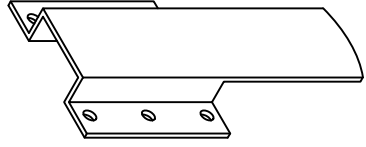
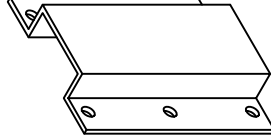
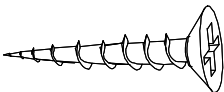
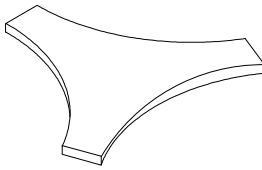
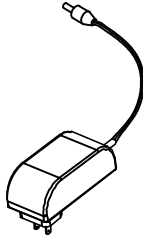
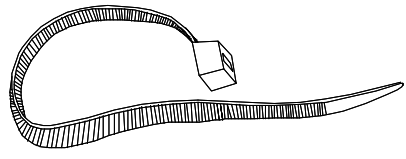
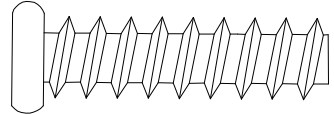
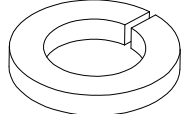
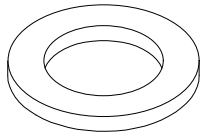
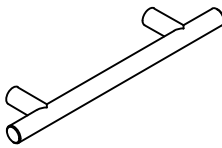
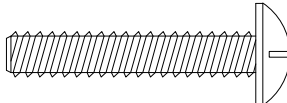
HARDWARE LIST

<p>①</p> 	<p>②</p> 	<p>③</p> 
<p>CAM BOLT QTY:8</p>	<p>CAM LOCK QTY:8</p>	<p>WOOD DOWEL QTY:4</p>
<p>④</p> 	<p>⑤</p> 	<p>⑥</p>  <p>Ø8*18mm</p>
<p>QTY:2</p>	<p>QTY:2</p>	<p>FLAT SCREW QTY:24</p>
<p>⑦</p> 	<p>⑧</p> 	<p>⑨</p> 
<p>CAM TOOL QTY:1</p>	<p>ADAPTOR QTY:1</p>	<p>PLASTIC TIE QTY:2</p>
<p>⑩</p>  <p>Ø1/4*38mm</p>	<p>⑪</p> 	<p>⑫</p> 
<p>BOLT QTY:8</p>	<p>SPRING WASHER QTY:8</p>	<p>FLAT WASHER QTY:8</p>
<p>⑬</p> 	<p>⑭</p>  <p>Ø8*25mm</p>	<p>⑮</p> 
<p>HANDLE QTY:1</p>	<p>BOLT QTY:2</p>	<p>ALLEN KEY QTY:1</p>

HARDWARE LIST

16

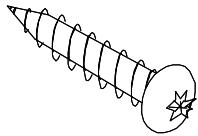

Ø7*15mm

17

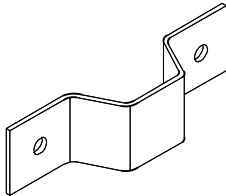

18

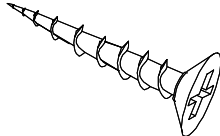

Ø8*38mm

ROUND HEAD SCREW QTY:4

HOOK

QTY:4

FLAT HEAD SCREW QTY:4

19

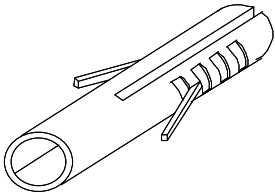

ANCHOR

QTY:4

Step 1

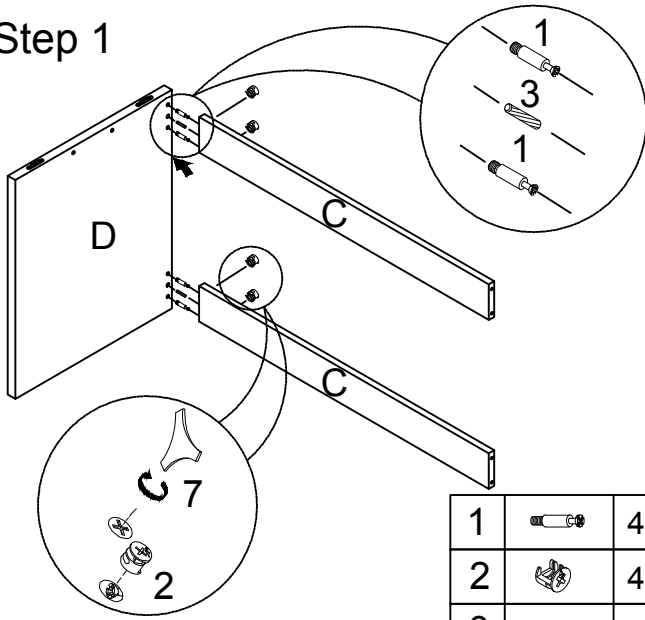

1		4PCS
2		4PCS
3		2PCS
7		1PC

Step 2

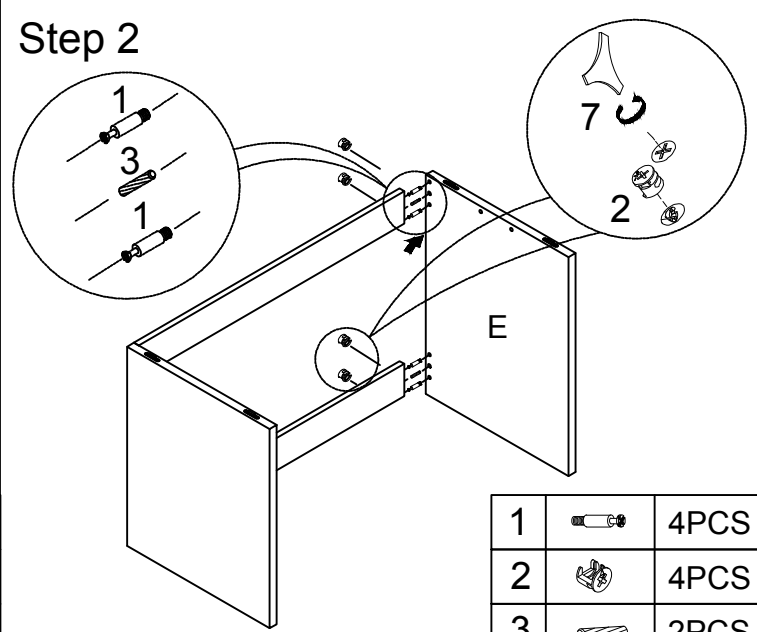

1		4PCS
2		4PCS
3		2PCS
7		1PC

Step 3

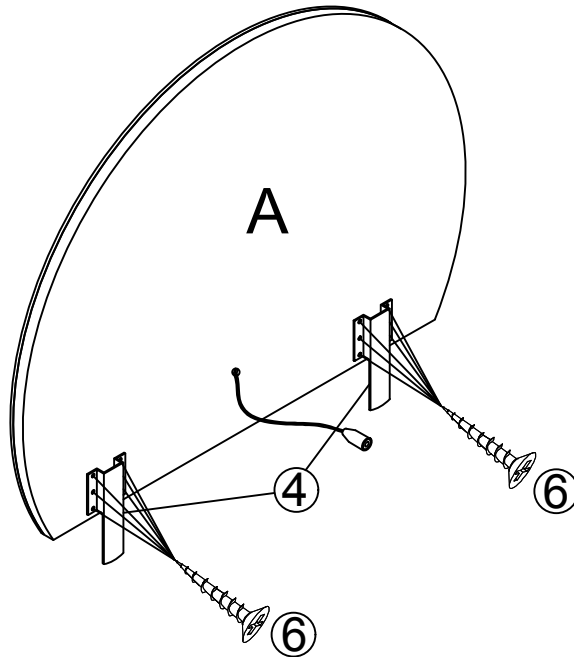

4		2PCS
6		12PCS

Step 4

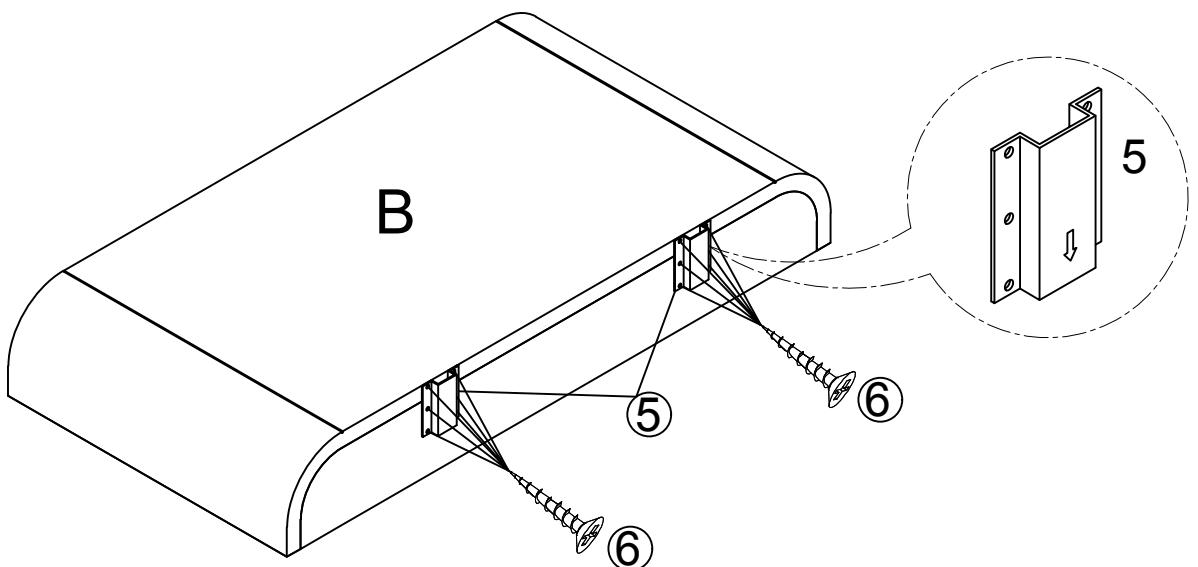

5		2PCS
6		12PCS

Step 5

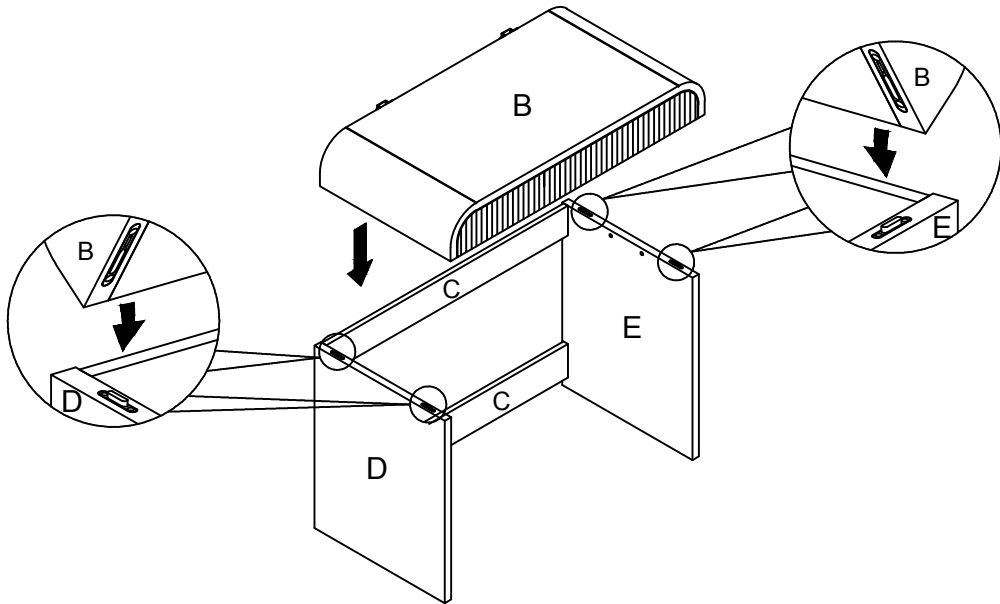

Step 6

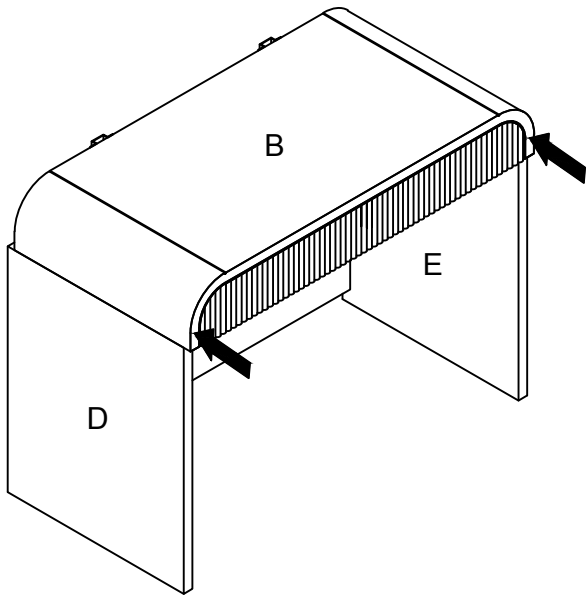

Step 7

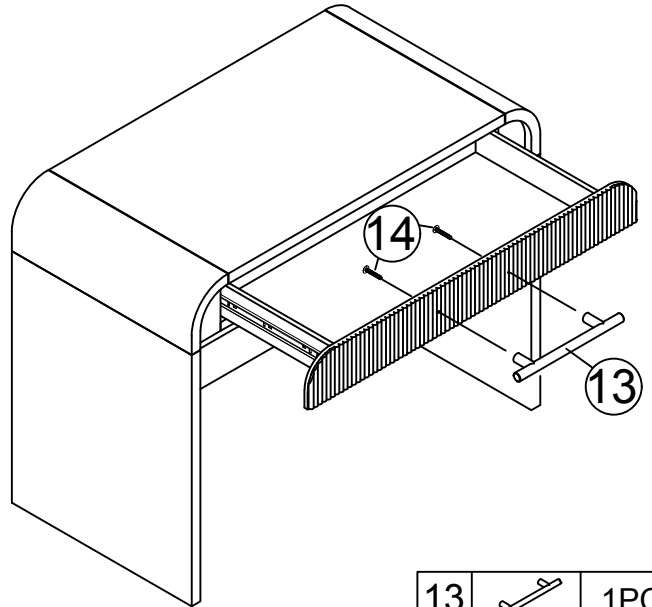

13		1PC
14		2PCS
10		4PCS
11		4PCS
12		4PCS
15		1PC

Step 8

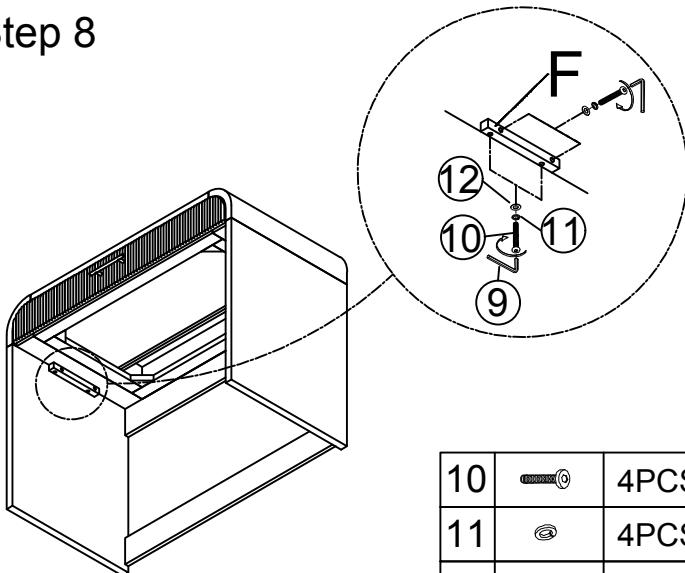

10		4PCS
11		4PCS
12		4PCS
9		1PC

Step 9

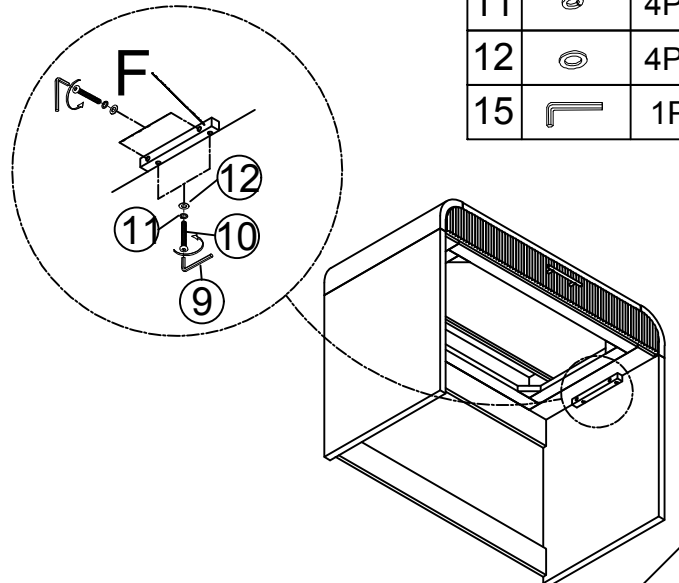

Step 10

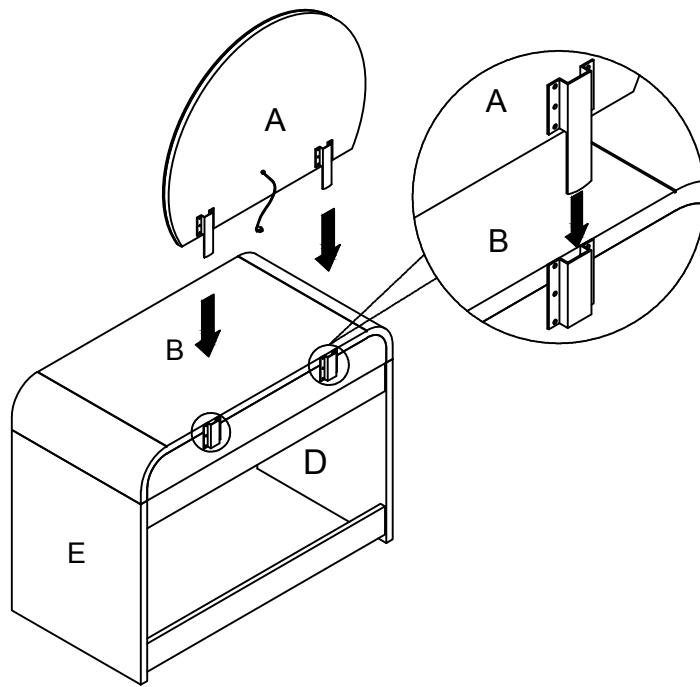

Step 11

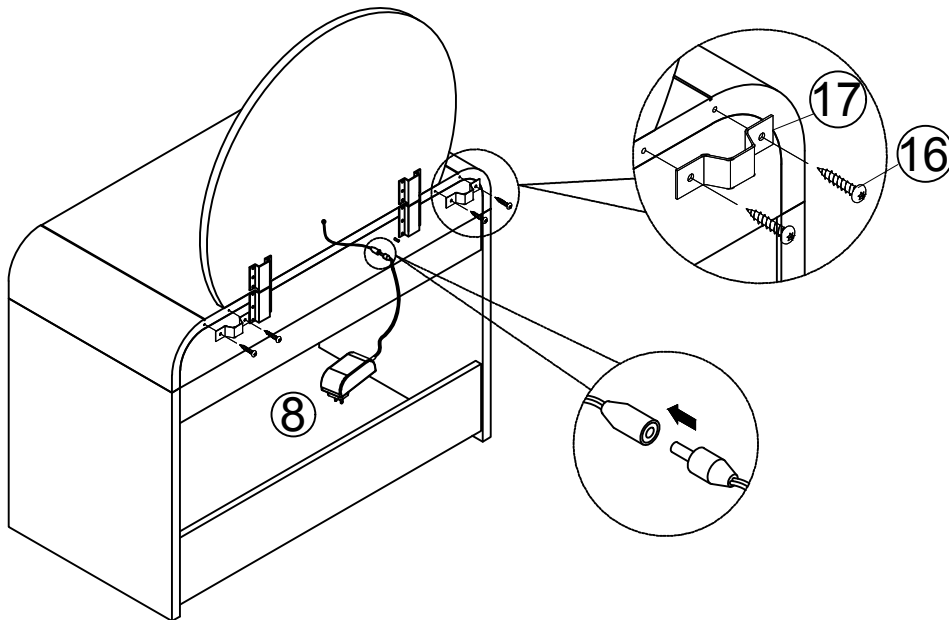

8		1PC
16		4PCS
17		2PCS

Step 12

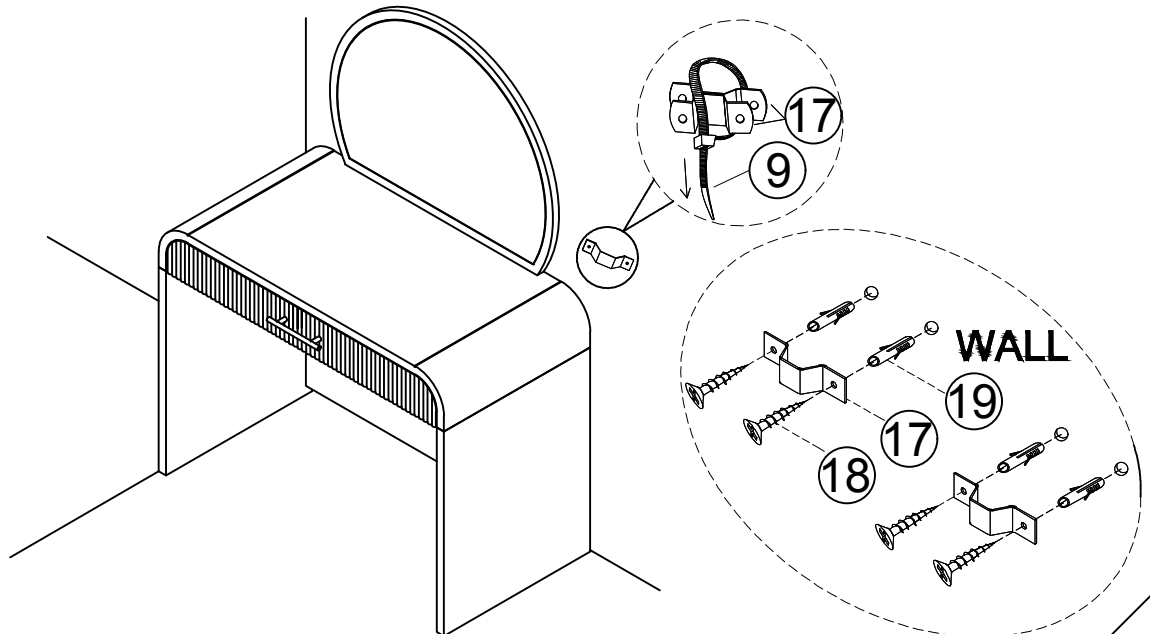

17		2PCS
18		4PCS
19		4PCS
9		2PCS