

AFTER-SALE SERVICE

If you have any suggestions for our products or find that the products have quality problems, please contact us first, our after-sales team will reply you within 24 hours, and we will do our best to give you solutions until you are satisfied.

AFTER-SALE SUPPORT

If you have any questions, please contact us via email (tfservices@163.com). We will be happy to serve you and guarantee a 100% satisfactory treatment plan.

 tfservices@163.com

Read all instructions BEFORE assembly and USE of product.

KEEP INSTRUCTIONS FOR FUTURE

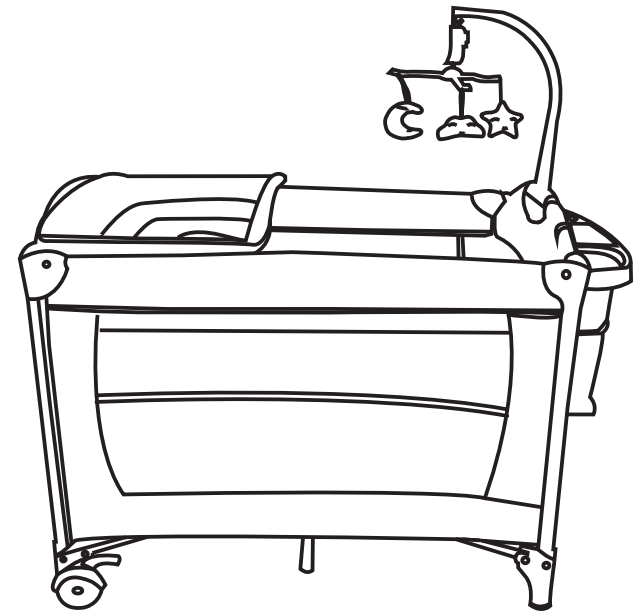

HWEYE INTERNATIONAL INC.
3790 DEFOREST CIRCLE JURUPA
VALLEY CA 91752-9913
Email Add:tfservices@163.com

USER'S MANUAL

**Baby Bed
ETC004**

CLEANING

Fabrics and the mattress may be spot cleaned by using a sponge with a mild soap and warm water solution. Leave to dry in a ventilated area away from direct sunlight. Do not dry clean, machine wash, bleach or tumble dry.

Metal parts may be cleaned with a damp cloth. Always wipe dry.

Clean plastic parts with a mild soap and warm water solution.

Avoid leaving the product in direct sunlight for prolonged periods of time as this may cause fabrics to fade.

PACKING LIST

This baby playard does not require the tools for assembly.

1

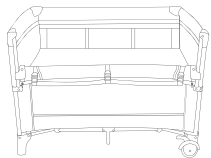

Basic Playard

2

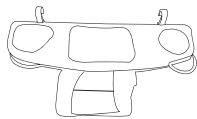

Side Storage Tray

3

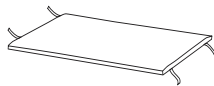

Mattress

4



Changing Table

5

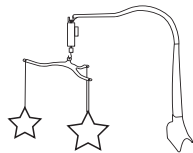

Toy Bar & Toys

6

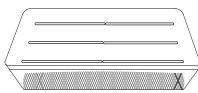

Bassinet

7

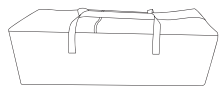

Carry Bag

8



Safety Belt

PLAYARD INSTRUCTION

WARNING

Failure to follow these warnings and the instructions could result in death or serious injury.

- Prior to use, the product must be fully erected, including side rails.
- Make sure latches are secure.
- Top support member must be installed prior to use. Failure to install may result in child falling out of product.
- Strings can cause strangulation! Never place items with a string around a child's neck such as hood strings or pacifier cords. Never suspend strings over product or attach strings to toys.
- Never place product near a window where cords from blinds or drapes can strangle a child.
- Child can become entrapped and die when improvised netting or covers are placed on top of product. Never add such items to confine child in product.
- When child is able to pull to standing position, remove large toys, mesh liners, and other objects that could serve as steps for climbing out .
- Discontinue use of the product when child is able to climb out or reaches the height of 35 in. (89 cm).
- Replace teething rail if damaged, cracked, or loose.
- Always provide the supervision necessary for the continued safety of your child. When used for playing, never leave child unattended.
- Always place baby on back to sleep to reduce the risks of SIDS and suffocation.
- Never use this product if there are any loose or missing fasteners, loose joints, broken parts, or torn mesh fabric. Check before assembly and periodically during use. Contact **XIAMEN KINGSUN CHILDREN CO., LTD.** for replacement parts. Never substitute parts.

! WARNING

- Never leave child in product with side lowered. Be sure side is in raised and locked position whenever child is in product.
- Never use plastic shipping bags or other plastic film as mattress covers not sold and intended for that purpose. They can cause suffocation.
- Never use a water mattress with this product.

SUFFOCATION HAZARD

Babies have suffocated:

- on pillows, comforters, and extra padding
- in gaps between product sides and a wrong size mattress or extra padding
- NEVER add soft bedding, padding, or an extra mattress.
- ONLY use the mattress as described in the warnings on this product.

STRANGULATION HAZARD

- Children have **STRANGLED** when their necks became trapped between accessories and play yard frames
- Remove the bassinet or changing table accessory anytime child is in the play yard. Ensure the mesh door on the end of the play yard is closed by zipper, when the child is in the play yard.

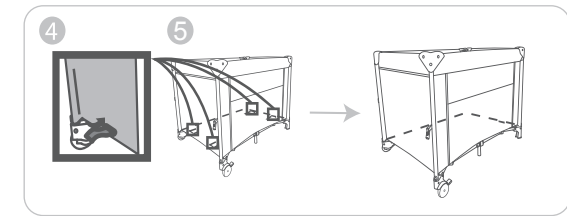
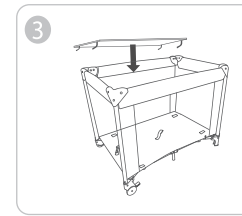
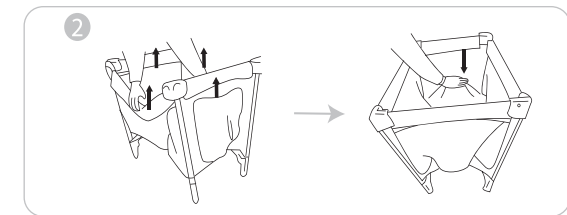
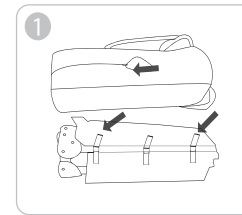
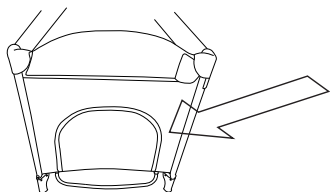

1. Undo the hook and loop fastener straps to remove the mattress.
2. Make sure the base is in the upright position and then lift each of the side rails upwards until they lock in place.
3. Only when all four top rails are locked, push the base down.
4. Place the mattress inside the product with the hook and loop fastener straps facing downwards.
5. Thread the straps through the slots and secure underneath.

TO FOLD FOR STORAGE:

Remove the mattress and liner if used. Using the loop in the bottom centre of the product, lift up as far as possible. Lift the side rails up squeeze the unlocking bottom of the rail. With the button held in, lower the rail downwards, and repeat for all side rails.

Whilst lifting the loop, pull all four corners together and then wrap the mattress around it and secure with hook and loop fastener straps.

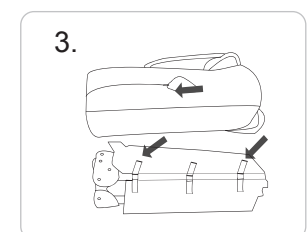
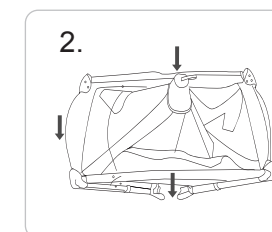
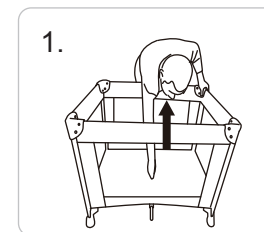

! WARNING

Failure to follow these warnings and the instructions could result in death or serious injury.

SUFFOCATION HAZARD

Babies have suffocated:

- On pillows, comforters and extra padding.
- In gaps between a wrong size mattress, or extra padding and product sides.
- **NEVER** add soft bedding or padding.
- Use **ONLY** mattress provided by manufacturer.
- Always place baby on back to sleep to reduce the risk of SIDS and suffocation.
- If a sheet is used with the pad, use only the one provided by the product manufacturer or one specifically designed to fit the dimension of the product mattress.

FALL HAZARD: To help prevent fall, do not use this product when the infant begins to push up on hands and knees or has reached 19.84lbs (9 kg), whichever comes first.

! WARNING

- Strings can cause strangulation ! Do not place items with a string around a child's neck , such as hood strings or pacifier cords . Do not suspend strings over the product or attach strings to toys.
- Do not use if any part of the bassinet is broken , torn or missing.
- Do not place the bassinet near a space heater, open fire or other source of strong heat.

1. Zip the liner into the inside of the baby playard.
NOTE: there are two separate zips. One zip runs around the two sides and back, and the front side zip is located below the level of the drop side rail. Ensure that all zips are securely fastened before each use.
2. Install six mattress support bars into fabric tunnels on the second sleeping layer.
3. Place the mattress inside the second layer.
Thread the straps through the slots and secure underneath.

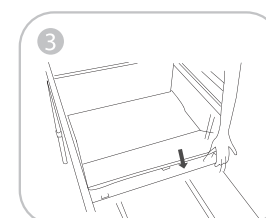
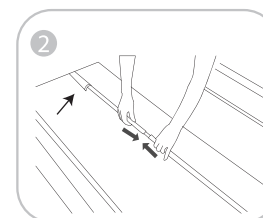
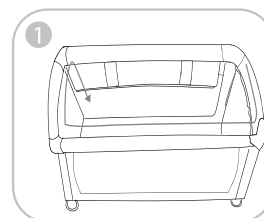

4. The product includes only one mattress.
To switch to the crib mode, the mattress must be removed from the base.

CHANGING TABLE ACCESSORY INSTRUCTION

! WARNING

FALL HAZARD: Children have suffered serious injuries after falling from changing table. Fall can happen quickly.

- **STAYS** in arm's reach of your child.
- **ALWAYS** secure this changing table accessory to the support frame by manufacturer's instructions for securing the changing table accessory.

SUFFOCATION HAZARD: Babies have suffocated while sleeping in changing areas. Changing areas are not designed for safe sleeping.

- **NEVER** allow baby to sleep in changing area.
- Read all instructions before use of this product.
- Do not use product if it is damaged or broken.
- Do not leave your child unattended in the changing table, never leave changing table in place when child in the baby playard.
- This changing table must not be used for children weight more than 30lbs (13.6kgs) or the age more than 12 month.

01 Insert two holding bars.

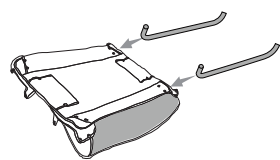

02 Connect two locker bars with holding bars.

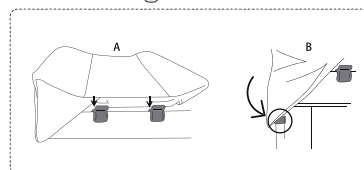
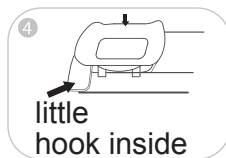
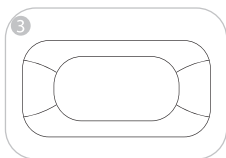
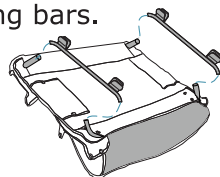

BEDSIDE SLEEPER AND ATTACHMENT SYSTEM INSTRUCTION

! WARNING

- This bedside sleeper is designed for use only with adult beds that are between 23-1/2 and 26-3/4 inches from floor to top of adult mattress.
- The bedside sleeper can only be used with adult bed that the mattress, box springs in line with the frame. See figure for acceptable bed configuration and unacceptable bed configuration:

Mattress, Box springs & Frame aligned



**ACCEPTABLE ADULT BED
CONDITIONS FOR C₀ SLEEPING
MODE (BEDFRAME IN-LINE)**

**UNACCEPTABLE ADULT BED
CONDITIONS FOR C₀ SLEEPING
MODE (BEDFRAME NOT IN-LINE)**

- Not suitable for use next to water beds or children's beds.
- Entrapment Hazard-To prevent death from entrapment, bedside sleeper must be properly secured to adult bed using the attachment system.
 - (1) There must be no more than 1/2 in. (13 mm) gap between bedside sleeper and adult bed.
 - (2) Check tightness before each use by pulling bedside sleeper in a direction away from adult bed.
 - (3) If gap exceeds 1/2 in. (13 mm), **DO NOT** use product. Do not fill the gap with pillows, blankets or other items that are suffocation hazards.
- Always use ALL required parts for each use mode. Check instruction manual for a list of required parts. Periodically check product for loose, damaged, or missing parts.
- To avoid death from the infant's neck being caught on the top rail on the side that is next to the adult bed, the top rail must be no higher than the adult bed mattress.
- The attachment system must always be used in bedside sleeper mode.
- Always read and follow assembly instructions for each product use mode (bedside sleeper, bassinet, playard).

! WARNING

- Assemble product according to manufacturer's instructions for ANY use mode--bedside sleeper as well as the bassinet or play yard modes, or both.
- A bedside sleeper is designed to provide a sleeping area for an infant until he or she begins to push up on hands and knees or approximately 5 months of age. Move your child to another sleeping product when your child reaches this stage.
- Read all instructions before assembling and using the product.
- Keep instructions for future use.
- **DO NOT** use bedside sleeper if any parts are missing , damaged or broken. Contact Us for replacement parts and instructional literature if need.
- **DO NOT** substitute parts.
- **DO NOT** use this product as a standalone sleeper.

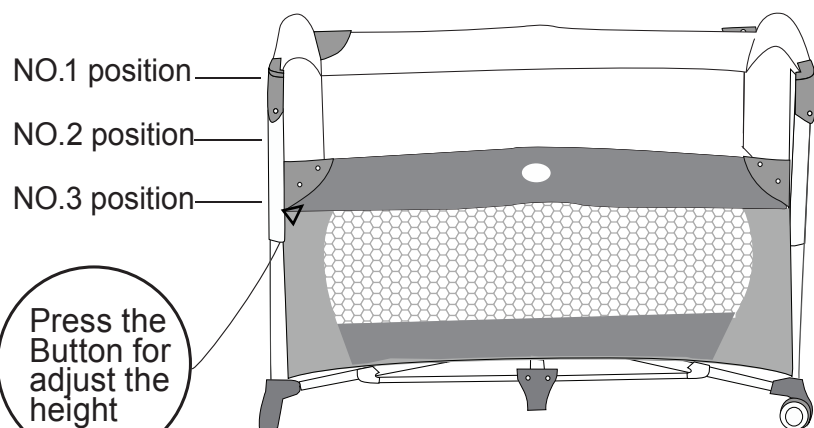

1. Bedside sleeper instruction :

No.1 position. We also call it bassinet mode ,when you use it in bassinet mode, please make sure the top rail is in the highest position.

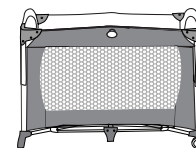

NO.2 position: Pull down the zipper, and at the same time, press the plastic buttons with two both.

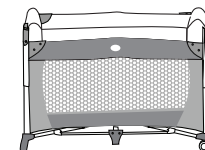

NO.3 position: Pull down the zipper, and at the same time, press the plastic buttons on both sides to lower .

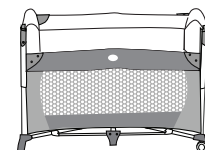

2. Attachment system instruction :

(1) Thread the fixing belt plate between the adult's mattress and pivot the plate so it lies flat against both the bed base and mattress.

(2) Connect the ends of the fixing belts to the buckles on each end of the cot and pull tight by adjusting the sliding sliders. Ensure the cot is tight against the bed.

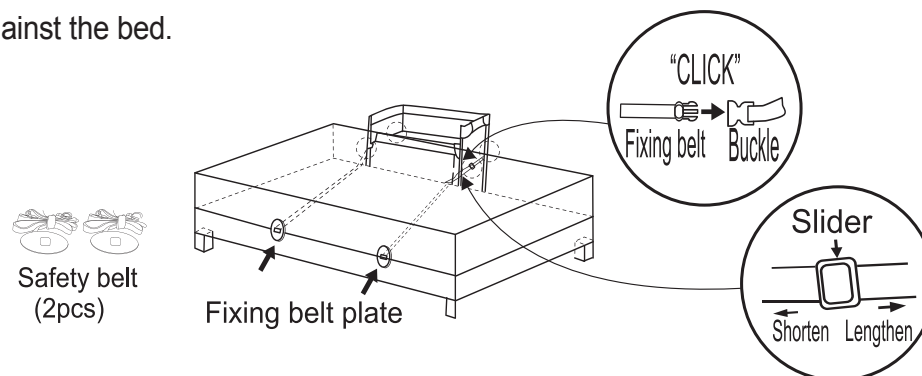

HOW TO USE TOY BAR & TOYS

WARNING

- The mobile toys are for babies from birth to 5 months.
- Possible entanglement or strangulation. Remove toy when baby begins to push up on hands and knees.
- The toy is to be assembled by an adult.
- A crib mobile is intended for visual stimulation and is not intended to be grasped by the child.
- Always attach all provided fasteners (strings, straps, clamps, etc.) tightly to a crib or playpen according to the instructions. Check frequently.
- Do not add additional strings or straps to attach to a crib or playpen .
- It contains potentially hazardous sharp points and small parts in unassembled state ,please keep out of reach of children.

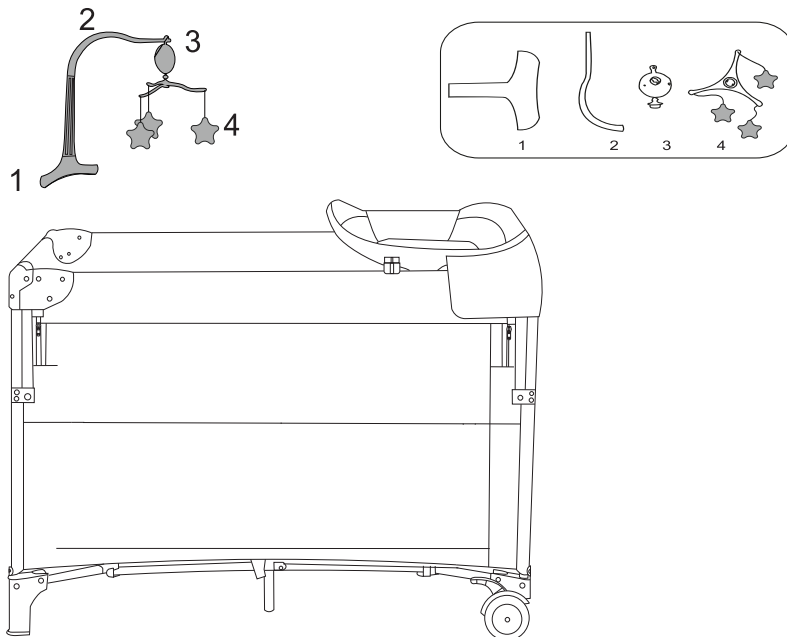

NOTE:

- 1 . This toy is not intended to be “mouthed” by the baby and should be positioned clearly out of reach of the baby’s face and mouth.
- 2 . On cribs with adjustable mattress levels, the highest position may allow the toy to be too close to the baby. The second or lower position is more appropriate.
- 3 . The drop side of the crib should never be lowered with the toy in place and the baby left unattended.
- 4 . Always attach all provided fasteners (strings, straps, clamps, etc.) tightly to a crib or playpen according to the instructions. Check frequently.
- 5 .Do not add additional strings or straps to attach to a playpen.

HOW TO ASSEMBLE SIDE STORAGE

WARNING

Please remove the storage rack when using the diaper changing table

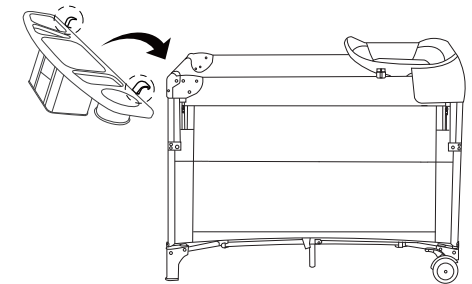

Hooking the side storage on the short side top rail of the playard.