





ASSEMBLY INSTRUCTIONS

TABLE

Thank you for purchasing this quality product. Be sure to check all packing material carefully for small parts that may have come loose inside the carton during shipment.

Hardware kit		
No	Description	Q'Ty
A	 Bolt 1/4" x 1-1/2"	8 pcs
B	 Lock washer 5/16"	8 pcs
C	 Flat washer 5/16"	8 pcs
D	 Allen Key	1 pc

Parts Key		
No	Description	Q'Ty
1	Table Top	1 Pc
2	Leg Assembly	2 Pcs
3	Side Stretcher	2 Pcs
4	Table Floor Glide	4 Pcs

STEP 1

- Carefully place the Table Top on the smooth surface.
- Attach the two Leg Assemblies to Table Top with Bolts (A), Lock Washers (B) & Flat Washer (C) using the Allen key (D). Do not tighten the bolts at this step. (See Detail A).

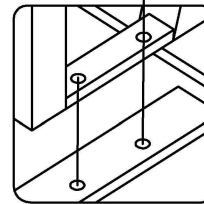
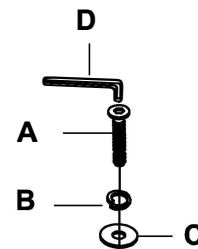
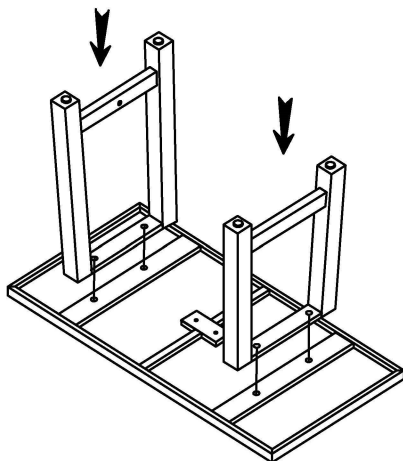

DETAIL A

STEP 2

- Attach the Side Stretcher between the Leg Assembly and the Table Top with Bolts (A), Lock Washers (B) & Flat Washer (C) using Allen key (D). Tighten all bolts at this step. (See Detail B) & (See Detail C).

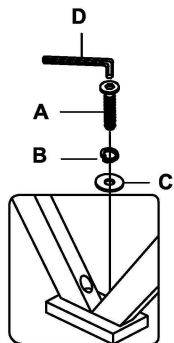

DETAIL C

DETAIL B

