

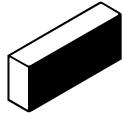





Assembly Instructions

Thank you for purchasing this quality product. Be sure to check all packing material carefully for small parts that may have come loose inside the carton during shipment. (Note: Loosely thread all screws/bolts first. Once the item is assembled then completely tighten.)

PARTS LIST:				HARDWARE LIST				
NO.	Description	Sketch	Quantity	NO.	Sketch	Description	Size	Quantity
A	Top		1pc	D		Blots	Ø5/16*1"	12pcs
B	Legs		4pcs	E		Flast washer	Ø5/16"	12pcs
C	Center Leg		1pc	F		Look washer	Ø5/16**3/4"	12pcs
				G		Allen wrench	M4	1pc

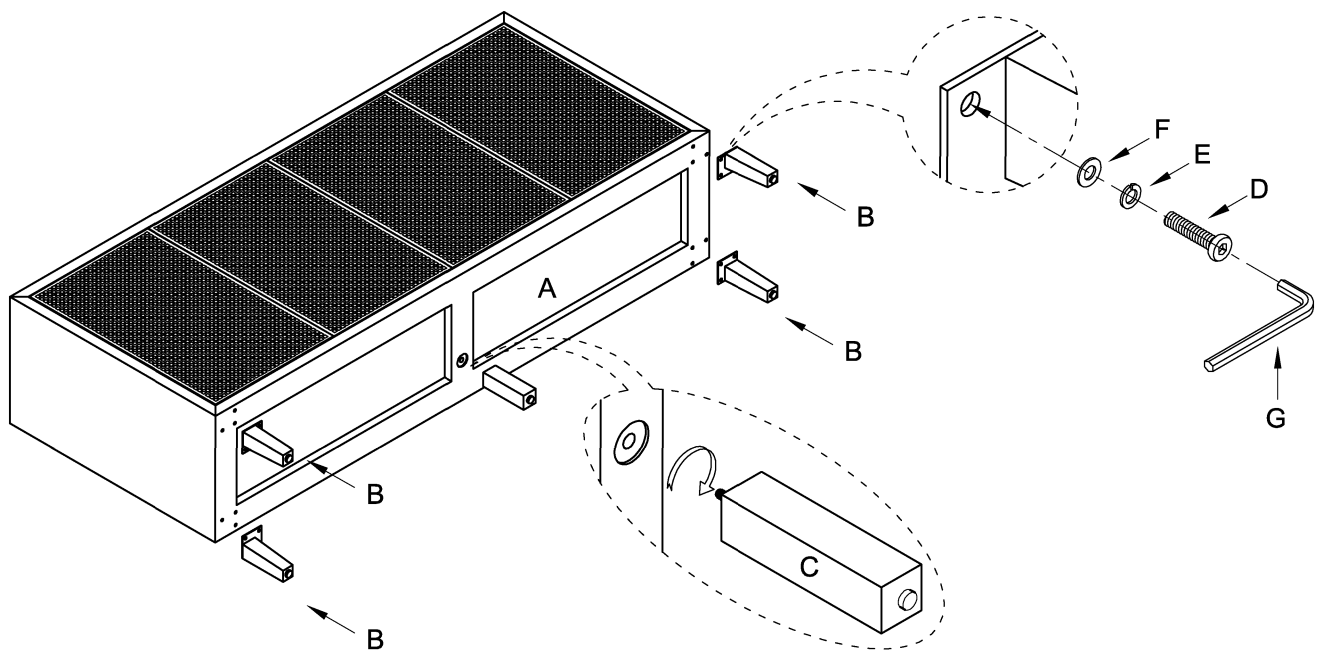

Tips: for a aligning doors:

Tip A: Sometimes the doors will not line up because of an uneven floor surface the furniture reats on. In that case, try adjusting the levelers found on the botton of each foot to aid in corecting.

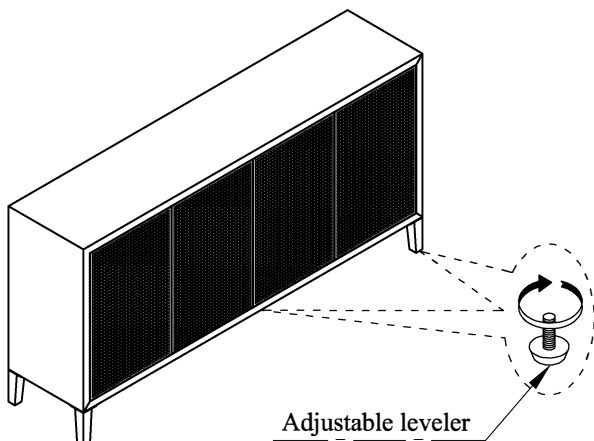

Tips B: If Tip A does not correct, you might want to take it a step further and try adjusting the hinges on the door. Please refer to the step by step figure instructions.

