

VII. Ceiling Fan Troubleshooting Solutions & Common Problems

Can't start	1. Check whether the fuse of the external power line of the ceiling fan is blown, whether the automatic protection switch is tripped and the circuit is broken.
	2. Check whether the voltage is seriously lower than the rated voltage of the ceiling fan.
	3. Check whether the internal wiring of the ceiling fan is loose or has poor contact.
Noise	1. Ensure the ceiling fan is not severely impacted before installation
	2. Make sure that the hanging pipe connecting bolt is installed correctly and the hanging pipe solenoid is locked.
	3. The new ceiling fan allows a 24-hour "trial period", after the trial period, most of the ceiling fan noise will disappear.
	4. It is not recommended to install on wooden ceilings, steel structures or prefabricated panels, as this will amplify the sound.
Fan wobble	1. Check whether the mounting bracket is locked
	2. Check if the screw of the lock blade is locked
	3. Check whether the screw of the blade retracted to the motor is locked

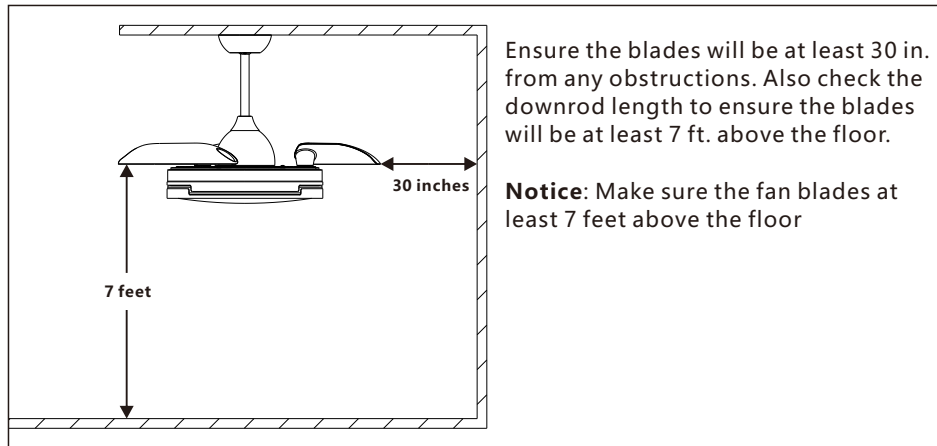

Installation Instruction

Luxury Decorative Ceiling Fan

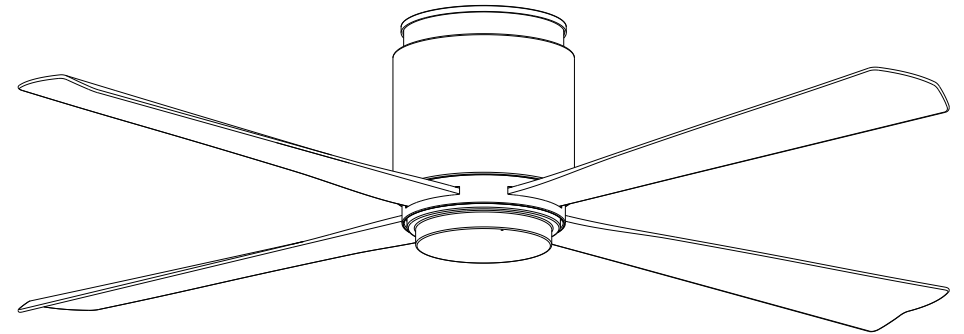

**54 inch
Wall Switch**

**WBCF-BS673/BS675/BS677/BS679
Series**

PLEASE READ AND SAVE THESE INSTRUCTIONS

GET MORE SUPPORT

Should you experience any issues while operating any of our products ,you can directly reach out to our Customer Support via Amazon Orders Or you can send your inquiry to our Official Customer Support at:

support@wingbolighting.com

I、Precautions

Before using this ceiling fan, please read this manual carefully and operate strictly in accordance with the procedures.

- 1 The input voltage of this product: 120V/60Hz
- 2 If you have insufficient knowledge of electrical appliances, be sure to hire an experienced expert to install them.
- 3 Before installing and disassembling the ceiling fan, please turn off the power first. The installation must be installed in the order of ground wire, live wire, and neutral wire. Before disassembly, it must be disassembled in the order of neutral wire, live wire and ground wire to avoid electric shock.
- 4 The ceiling fan must be installed on a solid ceiling, and the location of the ceiling fan must be able to withstand a gravity greater than 60 KG.
- 5 When installing the ceiling fan, all screws must be securely locked.
- 6 When the ceiling fan is rotating, no objects should touch the blades to avoid danger.
- 7 The angle and elevation of the leaf frame are determined after many repeated measurements, so it cannot be changed at will. When installing the leaf frame and blades, special care should be taken not to force collisions. If the angle and elevation angle of the leaf frame are deformed that will cause the ceiling fan to shake.

II、Prepare tools before installation:

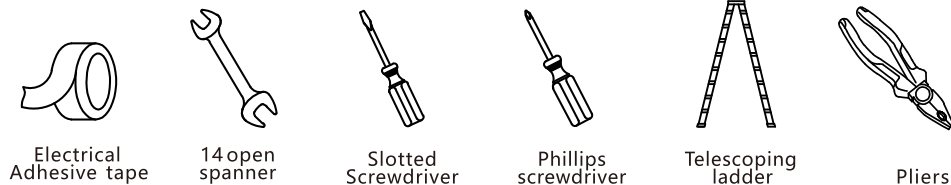

1









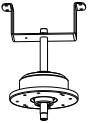

III、Basic parameters

- 1 Voltage: 120V/60Hz
- 2 Motor power: 35W
- 3 Number of blades: 4 blades
- 4 Fan blade material: ABS
- 5 Motor material: Pure copper wire winding and high-quality silicon steel stator, high efficiency, super quiet, energy saving.
- 6 Control method: Remote control/wall control (Turn on/off)
- 7 Diameter: 54 inch
- 8 Reversible: YES

IV、Ceiling Fan Kit Package List

※ Ceiling Fan Kit

Before the ceiling fan is installed, there are the following accessories in the carton, please check them one by one, if there is no shortage, you can install it.

 1*Motor	 1*housing	 1*Waterproof pad	 1*mounting plate	 1*Blade hub ring	 1*Bladed Disk
 4*Blades	 1*Decorative cover	 1*Hardware bag	 1*Remote control 1*Receiver	 1*Instruction	

V、Installation Procedures:

1. Secure the mouting plate.

First remove the mouting plate from the housing, (Figure 1), there are two different kind of screws to fix the plate, one work for concrete ceiling and the other work for wood ceiling(Figure 2), choose the right screws to fix the ceiling fan(Figure 3&4)

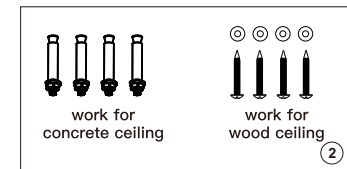
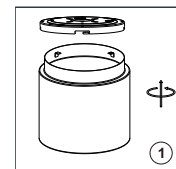

2

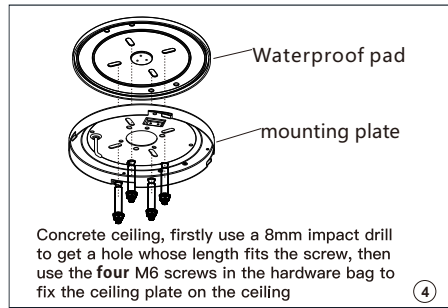
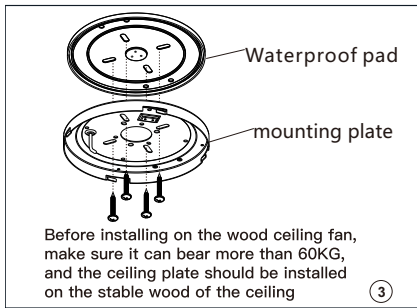

TIPS: Using different screws to secure the ceiling plate according to the different material of the ceiling, please do not install the ceiling plate on the ceiling which is unable to bear 60KG to prevent any potential danger. After the ceiling plate is located, make sure it can withstand more than 60KG, try to pull by hands to test if the ceiling is strong enough for safety.

2. Install the fan motor

- As shown in the figure 5, remove the four fixing screws on the ceiling plate, then take out the motor from the package.
- put the steel safety cable latch of the motor hangs into the ceiling plate hook, the four set screws through the hole of the hanger bracket and secure to the ceiling plate. (Figure 6)
- Take out the receiver from package, and connect the receiver wire to the motor wire together, (Figure 7).
- After the receiver wiring is completed, insert the receiver between the hanger bracket and ceiling plate. (Figure 8)

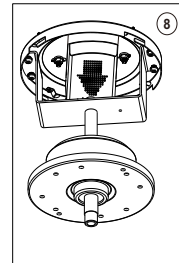
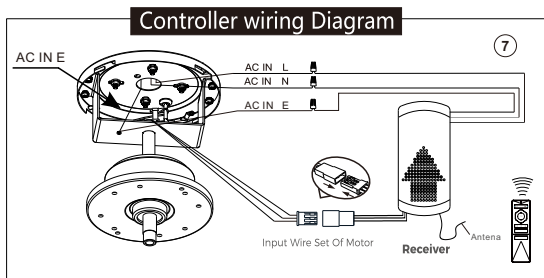
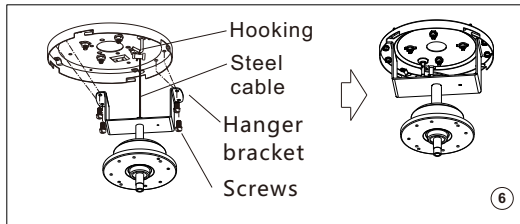
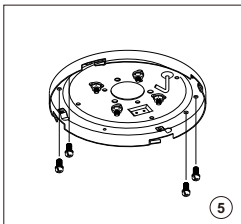

Use Effect:
 1.If a regular single pole switch is connected, it control to turn on or off the fan.
 2.If the regular single pole switch is not connected, the remote control can directly control fan.
Note: This Ceiling fan built in fan status memory function. When the power is turned off and turned on again, the fan will back to the last status. If the fan is turn off by remote control, the fan will keep the turn off mode. Need use remote control to turn on fan after the power switch on. If the fan is turn on before the power switch off, the fan will remember the turn on status, the fan will keep turn on once switch on.

ATTENTION:

Make sure the power is off when you are connect in these wires for safety, and make sure every wires is connected right place.

3. Wiring method of receiver: (Figure 7)

- Connect the ground wire from the ceiling to the two green/yellow wire from the installation bracket and the receiver (AC IN E).
- Connect the live wire from ceiling to receiver black wire (AC IN L).
- Connect the neutral wire from ceiling to receiver white wire (AC IN N).
- Plug in the motor wires in the correct way as indicated in the diagram.

4. Install the housing

- Align the lug of the housing with the notch of the ceiling plate, and rotate it clockwise to clamp the housing. (Figure 9)
- Align the locating holes of the Blade hub ring, Bladed disk, and the motor. Then, retrieve the mounting screws from the hardware kit and use them to secure the Blade hub ring and Bladed disk onto the motor. (Figure 10-11)

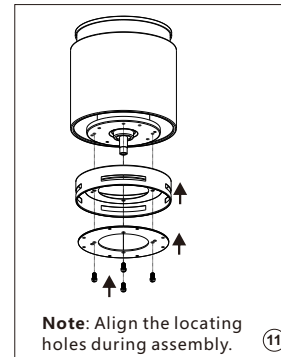
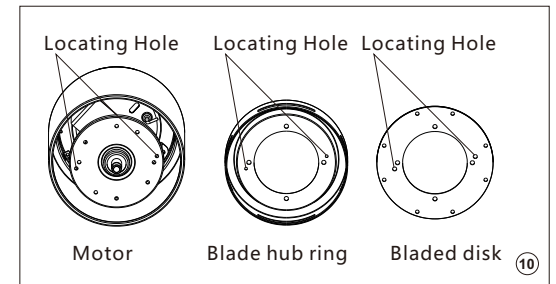
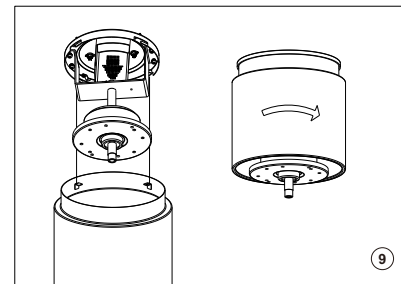

5. Install fan blades

Remove the pre-installed screw from the Bladed disk. Secondly, slide the blade into the slot on the fan motor assembly. Fasten it securely with the blade holder screws. (Figure 12)

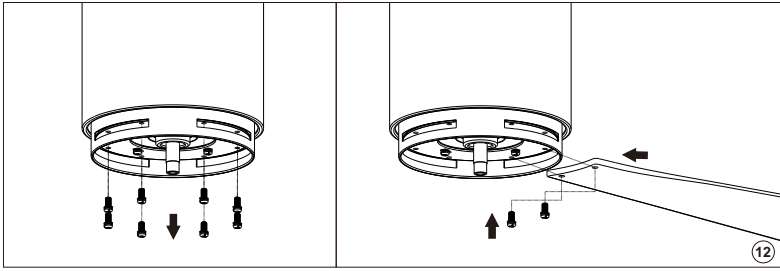

6. Install the decorative cover

- a. Rotate the decorative cover clockwise to the appropriate position. (Figure 13/14)

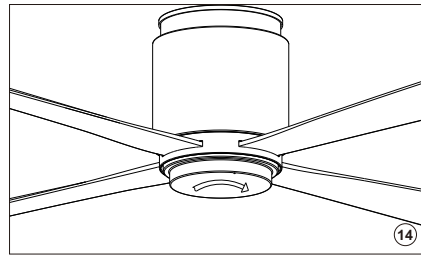
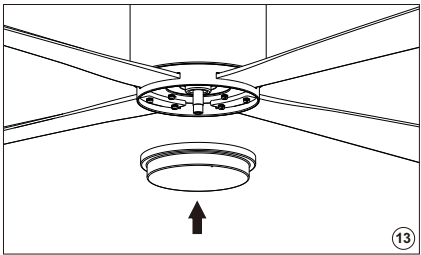

7. Balance adjustment method of ceiling fan

If there is any shaking after installing the ceiling fan please check if the screws that fix the hanger ball, mounting bracket, hanger, blade holder, and blade are locked.

If one of the above parts is not locked tightly, please re-lock it. If it is locked, please try the following ways to adjust the balance.

- a. Change the position of the fan blades: (Figure 15)

- 1). As shown in the figure 14 on the right, please remove the blades 1 and 2 and then lock each other to the opposite position to observe the effect.

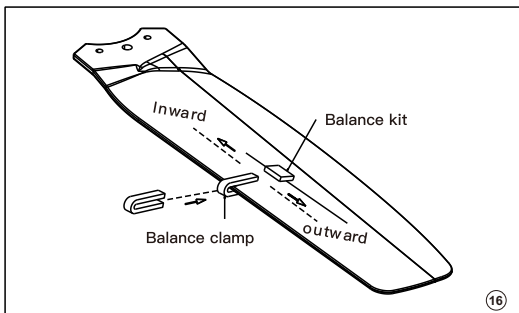
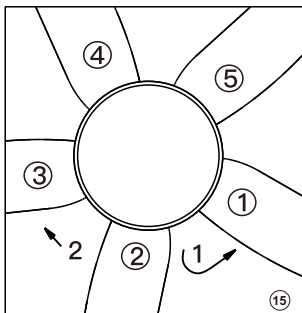

- 2). If there is no improvement after step a. Please remove the fan blades 2 and 3 and re-lock each other to the opposite position to observe the effect.

b. Adjust with balance pack

- 1). Take out the balance bag from the packing box, use a balance clamp to select one of the fan blades and clamp the balance clamp on the edge of the tail end of the fan blade (as shown in Figure 16 on the right)
- 2). Turn on the fan to see whether the shaking of the ceiling fan has been reduced. If it does not improve, try another fan blade. Experiment with all the fan blades in turn to find the blade with the weakest clamping balance.
- 3). Clamp the balance clamp on the fan blade with the weakest shaking, move it in or out on the edge of the fan blade, turn on the ceiling fan to find the best position of the balance clamp to control the shaking balance (as shown in the right Figure 16)
- 4). Take the balance sticker, tear off the double-sided tape of the balance sticker, and stick the balance sticker on the center of the blade at the position of the balance clip (as shown in the right Figure 16)

VI. Precautions

Warning

In order to prevent fire and electric shock, it is forbidden to install and use the electric switch which is not equipped with this ceiling fan.

Maintenance and repair of ceiling fans

1. It is recommended to check the connecting parts of the fan at least once a year. such as the hanger, the hanging pipe fastening screw and the fan blade, to ensure that their connection is still safe and reliable.
2. Clean the ceiling fan regularly to keep the surface clean and clean. When removing surface dust, please use a soft brush or cloth. When removing oil or laminate, wipe it off with a slightly wet cloth. Do not rinse with water directly.
3. Motor bearing is already provided with grease, do not add lubricating oil to the motor of ceiling fan. To avoid scratching the surface.