









S1x28  $\frac{25}{1.0}$	S2x10  $\frac{20}{0.8}$	S3x24  $\frac{18}{0.7}$	S4x20  $\frac{10}{0.4}$	S5x2 
--	--	--	--	---

S6x1 	S7x2 	S8x1 	Ax2 A-1 x2 S2x4  A-1 x2+S2x4	Bx2 
---	---	---	---	--

C 	D 	E 
---	---	---

F 	Gx2 	Hx2 
--	--	--

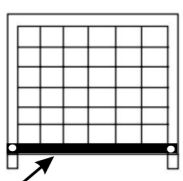
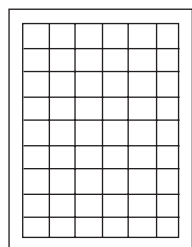
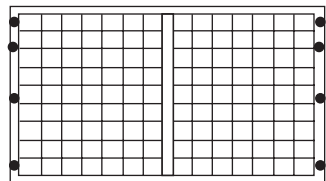
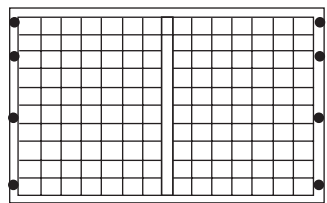
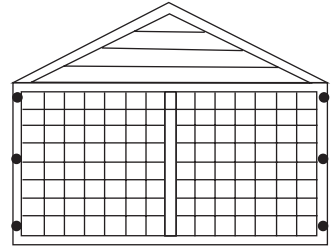
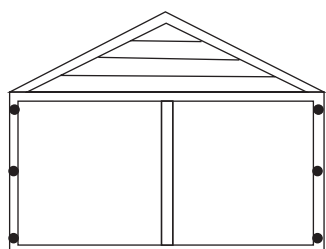
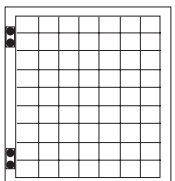
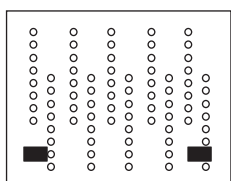
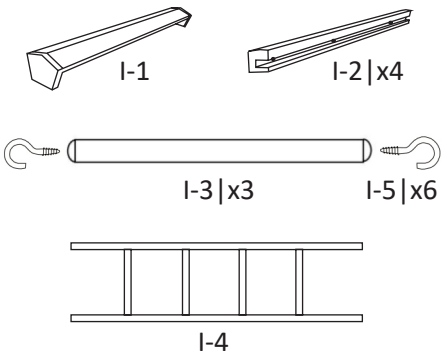
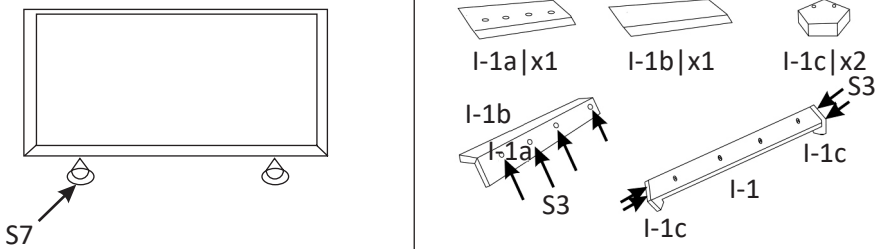
I 	J 
---	---

1

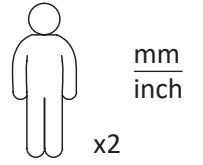
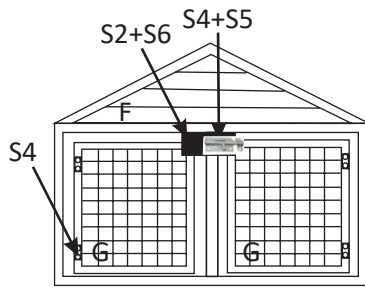

2

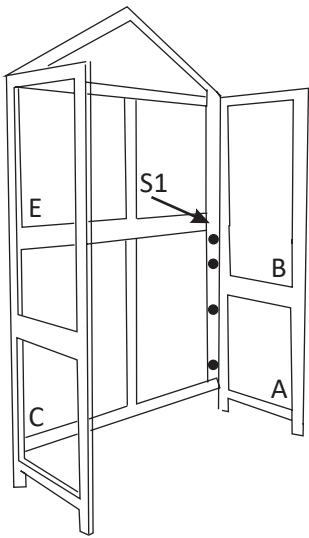

S1x14
Ax2
Bx2
Cx1
Ex1

3

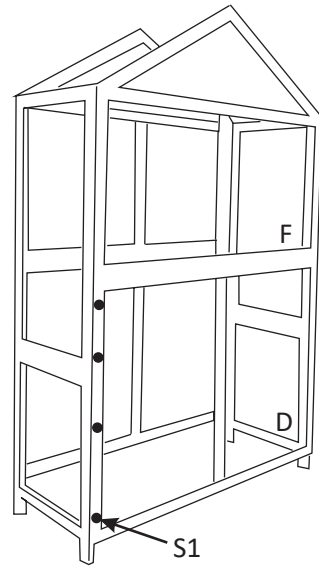

S1x14
Dx1
Fx1

4

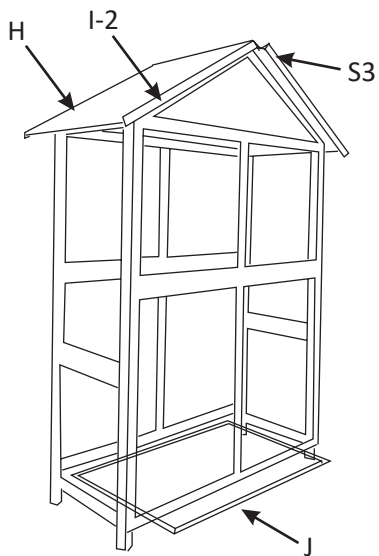

S3x16
Hx2
I-2|x4

5

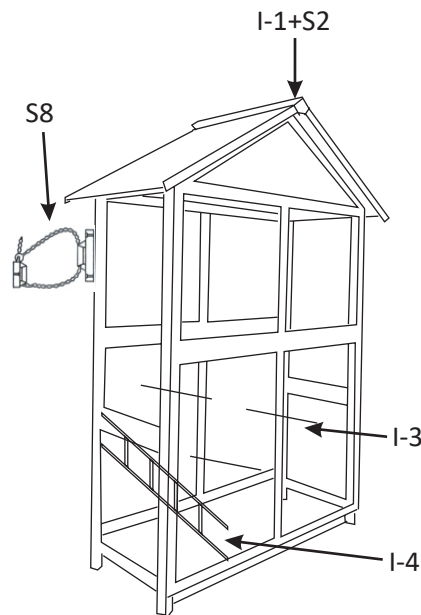

I-1
I-3|x3
I-4
S8x1
S2|x4