

# Side Table

SKU WHIF2402

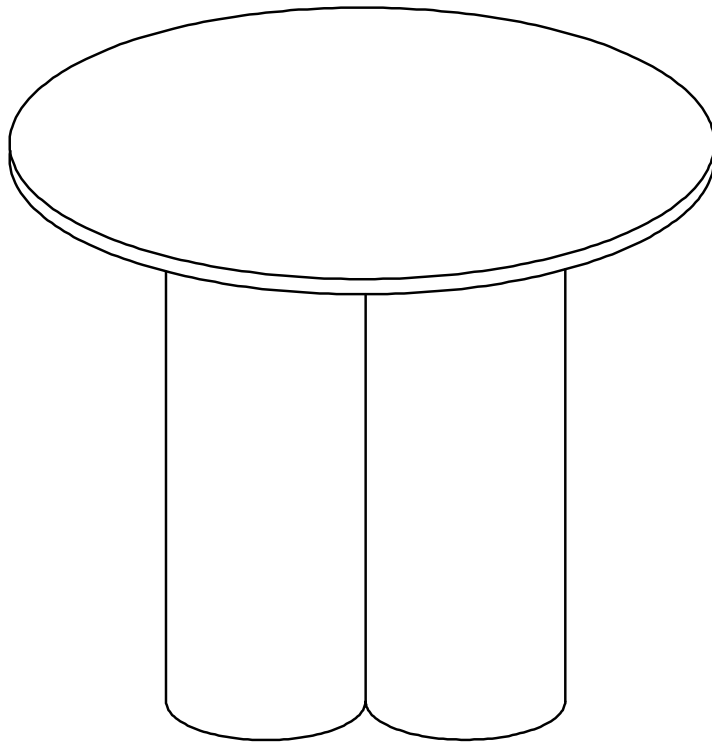

## ASSEMBLY INSTRUCTIONS



20 min. assembly

1 person

\*The estimated assembly time may vary depending on the individual.

# Hey, there

Now is assembly time!

Deeeeeeep breathe.... and again....  
Tools ready,  
Easy peasy!

## Estimated



20 min. assembly  
1 person

## Tools Required

- Allen Wrench (included)

**important:** *Cautious when you use power tools*

## Need Help?

Call us at +1 909 548 6688  
Email [customerservice@luxenhome.com](mailto:customerservice@luxenhome.com)  
Submit a ticket on [www.luxenhome.com/help](http://www.luxenhome.com/help)

Thank you for purchasing this LuxenHome product. This product has been manufactured with the highest standards of safety and quality.

### **PLEASE READ ALL INSTRUCTIONS CAREFULLY BEFORE ASSEMBLY.**

Unpack all parts from the packaging inside the carton to ensure there are no missing or damaged parts. Lay out all the parts on a clean, flat, and soft surface to prevent scratches. Refer to the steps provided as assembling guide.

Do not attempt to assemble or use the product if any parts are missing or damaged.

## REMINDERS

### **SAFE USAGE IS KEY**

Your well-being is our top priority when you use our product. Please prioritize your safety by diligently following the assembly guidelines and inspecting the product carefully both when it arrives and before each use.

Please be aware that LuxenHome and Winsome House, Inc. cannot be held liable for any injuries or fatalities that occur due to not adhering to the provided instructions or misuse of the product.

### **DO NOT MODIFY**

Our products undergo rigorous testing to ensure they meet established safety standards before being released for sale. Altering the product in any way can lead to serious safety concerns, for which LuxenHome cannot assume responsibility.

# What's in the box

## Parts



**1** X 1  
Tabletop

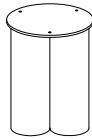

**2** X 1  
Leg of a table

## Hardware & Accessory

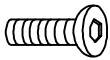

**A** X 3  
M6 x 15mm



**B** X 3  
Ø13xØ6 x 1mm



**C** X 1  
M4



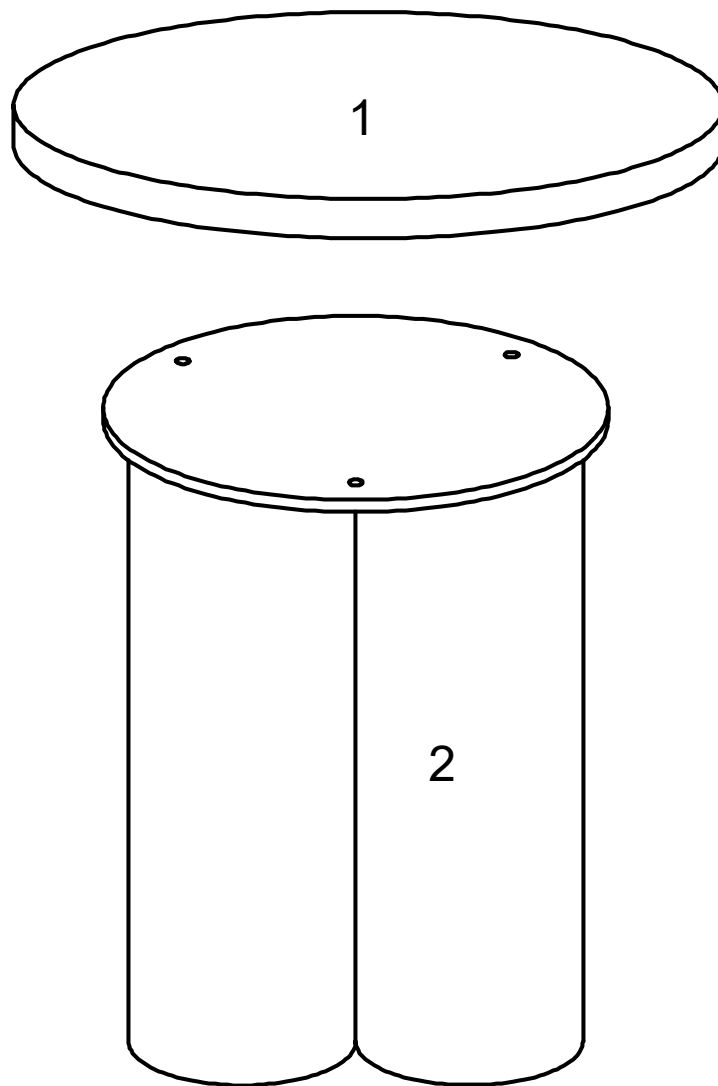

**D** X 3  
Felt Foot Pad

# Assembly



# Step 1

Use a wrench (part C) to connect (part 1) to (part 2) with the Bolts (part A) and the Flat washer (part B).

<b>A</b> X3	<b>B</b> X3	<b>C</b> X1
 M6 x 15mm	 Ø13xØ6 x 1mm	 M4

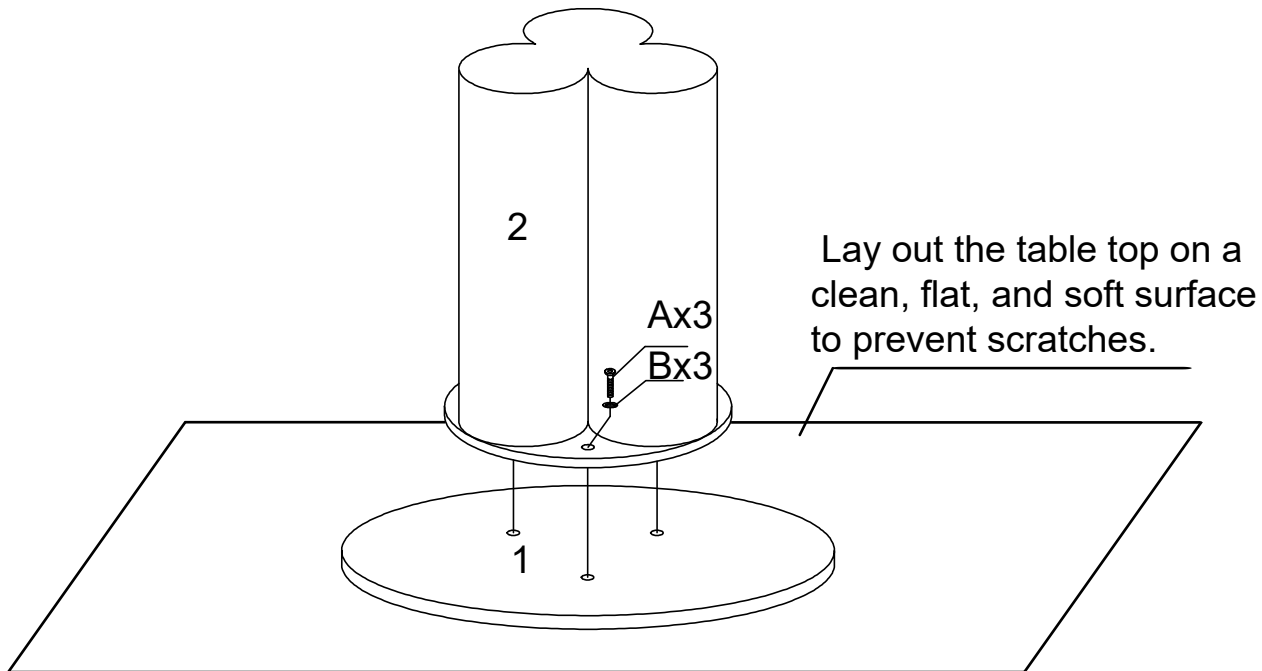

# Step 2

Stick foot pads (part D).

<b>D</b> X3
 Felt Foot Pad

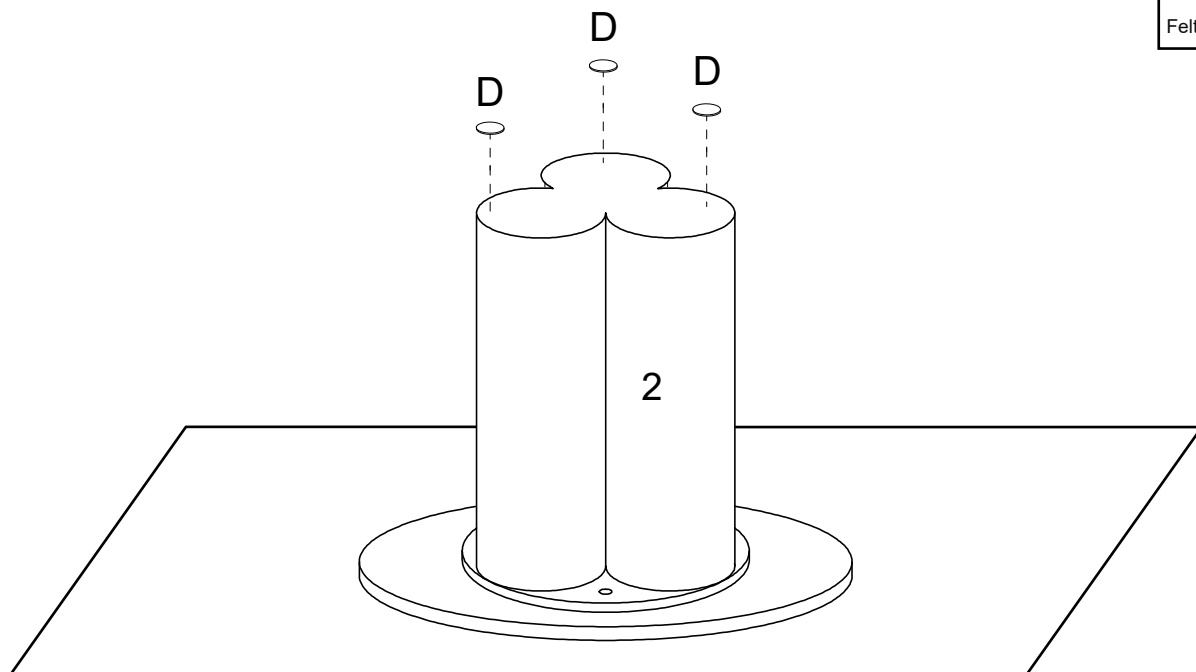

# VOILA!

Now enjoy.

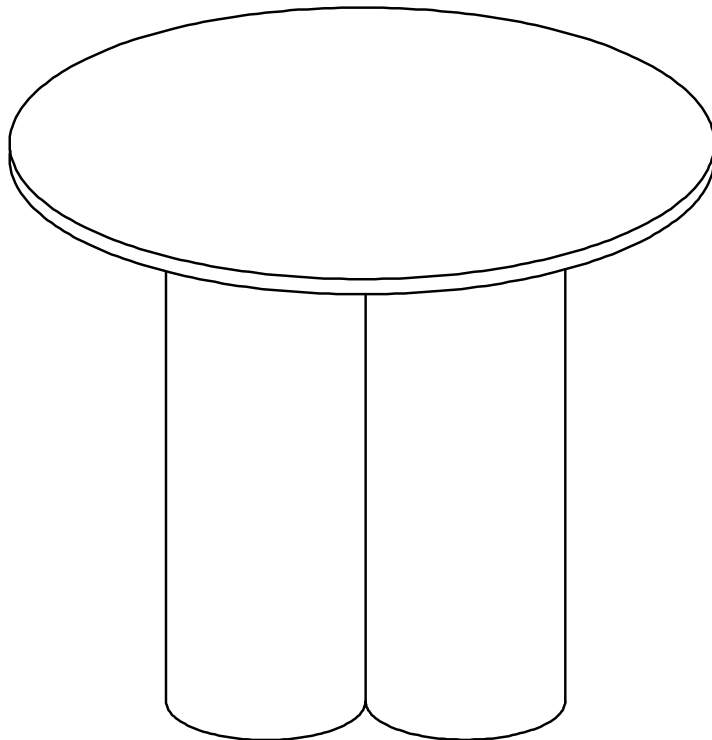

## **Warning**

DO NOT stand or sit on the table as this may damage the product and cause serious bodily injury.

# Something not right?

We are always here to help.

## **We make mistakes like every human does.**

Though we always strive to provide the best possible products at competitive prices and the best service in the industry, it's not possible to completely eliminate mistakes. If you experience any dissatisfaction, feel free to contact us immediately. Our in-house customer care team will respond ASAP.



[customerservice@luxenhome.com](mailto:customerservice@luxenhome.com)  
Get response within 24 hrs



909.548.6688  
Mon-Fri 9am-5pm PST/PDT



[www.luxenhome.com/help](http://www.luxenhome.com/help)  
Submit a ticket on our website

## **Things to do to expedite the process**

- Have your order# ready
- Take photos/videos to help us better identify the issues
- DO NOT throw away the packaging

# Happy with our product?

## Leave us a review

It really help us as a small business

- Find the product you purchased on our website (tip: search by SKU) and leave us a review.
- Alternatively, you can always return to the marketplace where you purchased it and leave a review there.

## Share with others

Our customers look for REAL stuff



- Follow us on IG @luxen.home
- Share your #liveluxen moments



**Please save this manual  
for future reference.**