

INSTRUCTION MANUAL

11 Ft x 11 Ft Pop Up Canopy with Netting

After Sale Service: service@joysidefurniture.com

WhatsApp: +86 18801006086

WARRANTY

Please read and save these instructions before attempting to set up this canopy.

3-month Limited Warranty

We warrant for a period of 3 months from the original date of purchase, this product against any defects in materials or workmanship. At its discretion, we may provide replacement parts to original purchaser. Original receipt or proof of purchase as well as proof of defect is required. We will not be responsible for shipping costs incurred outside the continental USA. Warranty is valid for the original purchaser for 3 months from the date of purchase and is not transferable. This warranty does not cover any product purchased through non authorized dealers and/or on-line auction websites."

This Warranty Does Not Cover

This 3 months Limited Warranty does not cover normal wear and tear, abuse or misuse of this product including damage from inclement weather conditions, such as wind, rain, or hail. In case of inclement weather, take down and store the canopy, remove, and store valuables, and seek appropriate shelter.

Under no circumstances, we will be liable or responsible for any incidental or consequential damages.

This product is designed and intended for commercial and recreational usage. Pro-longed exposure to UV rays will cause any fabric to fade and deteriorate and is NOT covered by this 3 months Limited Warranty.

All replacement products or parts will assume the remaining warranty of the original product. This warranty gives you specific legal rights. You may also have other rights, which vary from state to state.

It is your responsibility to read and save these instructions before attempting to set up your commercial canopy. We would also like to suggest that you follow these safety precautions, care and maintenance tips when using your canopy.

1. Never set up or continue to use in any rain, wind or storm conditions, especially lightning storms. Damage can occur to your canopy and put you and others in potential danger.
2. We suggest that you take your time to avoid bending the frame or pinching your fingers or hands while opening and closing the frame.
3. Avoid setting up your canopy on steep inclines.
4. Do not use your canopy for permanent shelter. It is designed for temporary use only.
5. Keep your canopy away from heat and flames at all times. Do not barbecue or build fires under your canopy.
6. Never leave your canopy unattended.
7. Hand washes the canopy using only mild soap and water. Never use harsh detergents, abrasives or bleach. Do not machine wash fabric components.
8. Never fold or store your canopy when it is wet or damp. Let it dry completely to avoid mildew.
9. The frame **MUST** be staked or properly weighted down at all times.
10. For best results in keeping your top clean and avoid small rips and tears, it is recommended that the top be removed from the frame and stored in the carry bag after each use.

PACKING INCLUDES

Part List

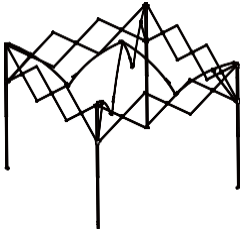

A - Canopy Frame (1pc)



B - Eave Extender (4pcs)

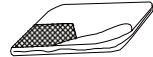

C - Small Top (1pc)



D - Big Top (1pc)

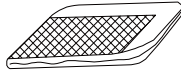

E - Mosquito Netting (1pc)

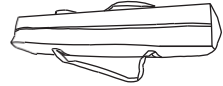

F - Carry Bag (1pc)

Hardware



AA - Stake (8pcs)



BB - Big Stake (4pcs)



CC - Rope (4pcs)



DD - Netting Rope (2pcs)



EE - Ring (32pcs)

ATTACH THE BIG TOP

Step 1

You will need:

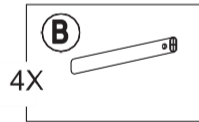
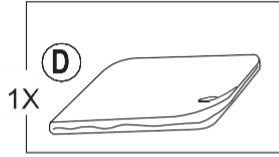
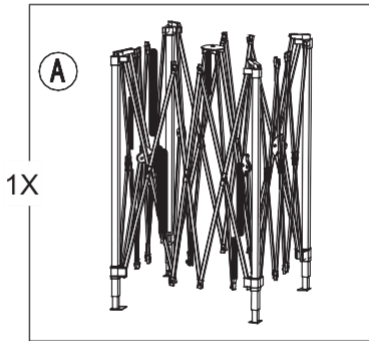

- Partially open the frame (A).
- Insert the exposed end of the eave extender (B) into the fittings at each corner of the frame (A) . They will click into place.
- Unfold the large canopy top (D) and place it over the open frame. Align the corner pockets with the frame corners.
- Pull the corner of the canopy over each each Eave Extender tube, making sure the tube goes inside the canopy pocket.

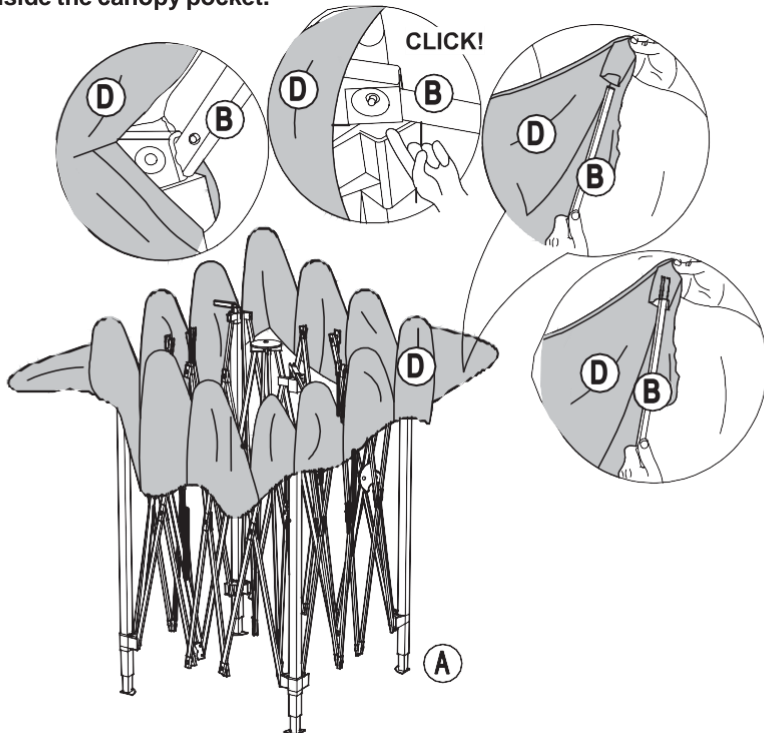

ATTACH THE SMALL TOP & UNFOLD THE CANOPY

Step 2

You will need:

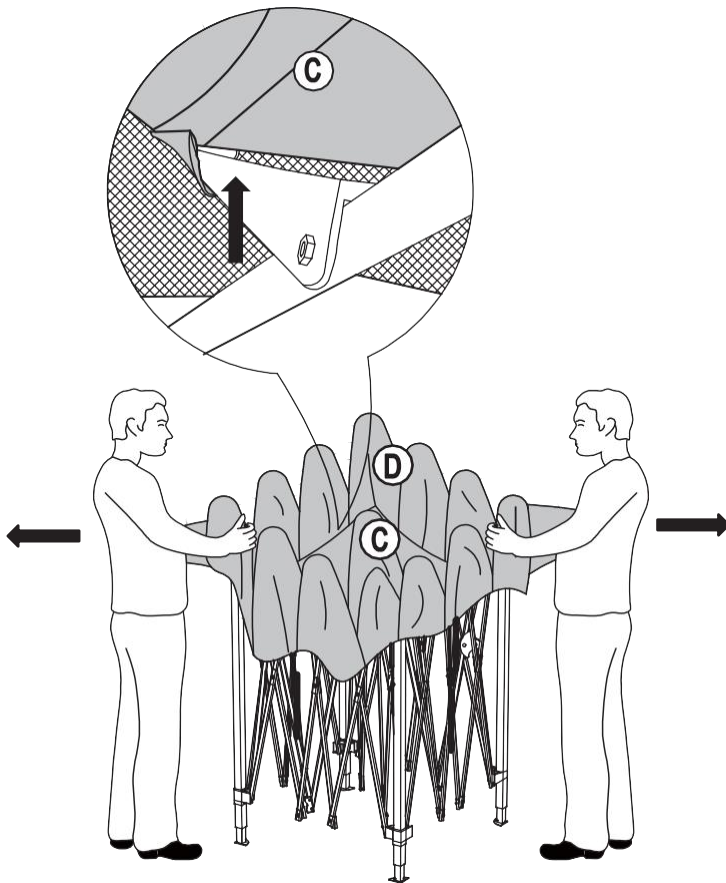
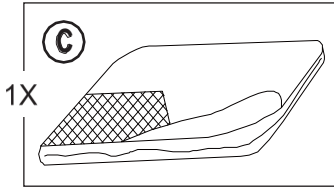

- Place the small canopy top over the central hub of the frame. Secure each of the four corners of the solid fabric onto hooks of the central frame as shown.
- With the help of another person, pull the frame outward from opposite corners to unfold your canopy.

LOCK THE FRAME & ADJUST THE CANOPY HEIGHT

Step 3

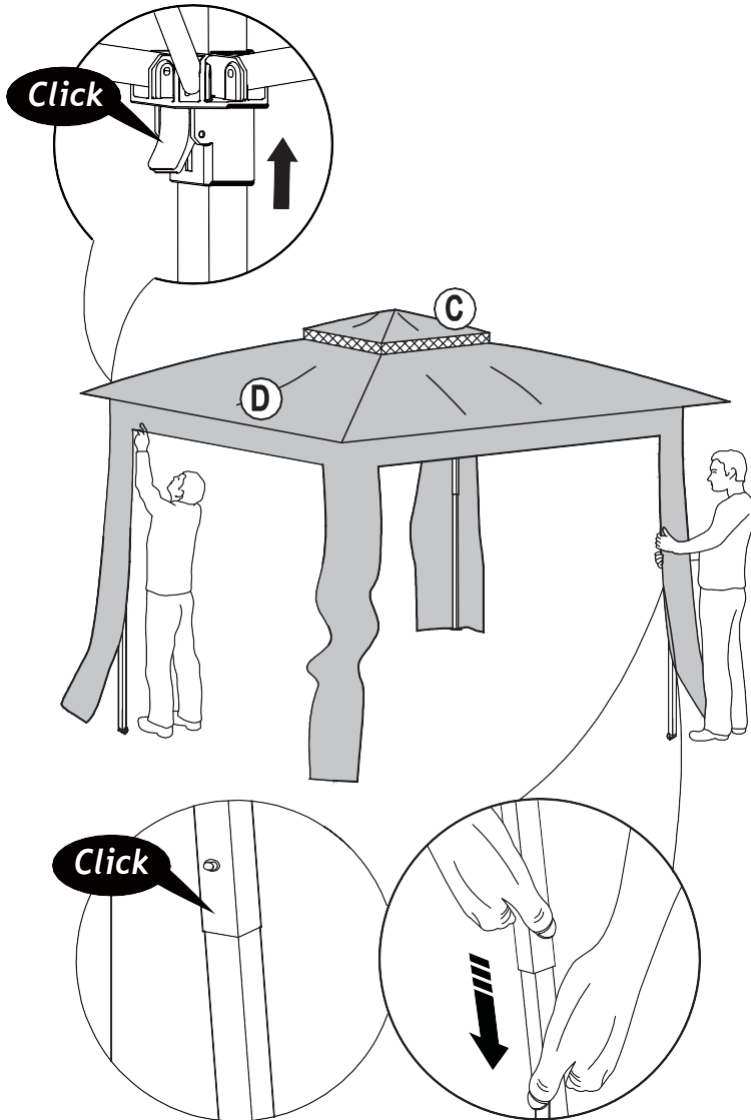

- Raise and lock your canopy frame by pushing the corner slider up until each one locks into place.
- Your canopy height is adjusted by pushing the circular push pin in to unlock the legs. Pull or push on the bottom leg section to raise or lower the canopy height.

ATTACH THE NETTING ROPES

Step 4

You will need:

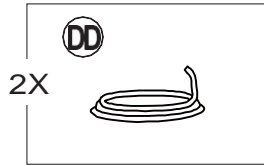

- Secure the ends of the ropes to adjacent corners of the frame above each leg by tying a knot.
- Reinforce the ropes on each side by securing them with the included velcro straps.
- Finish attaching the large canopy inside the canopy frame using the Velcro loops.

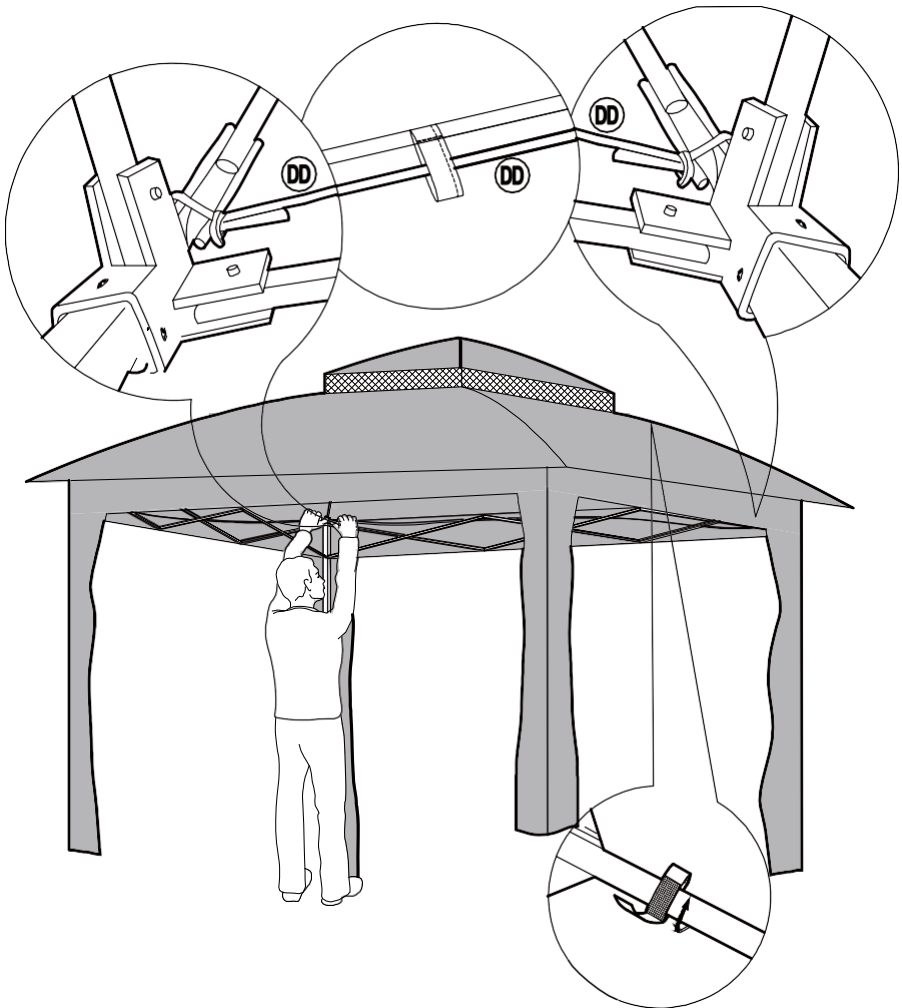

ATTACH THE MOSQUITO NETTING

Step 5

You will need:

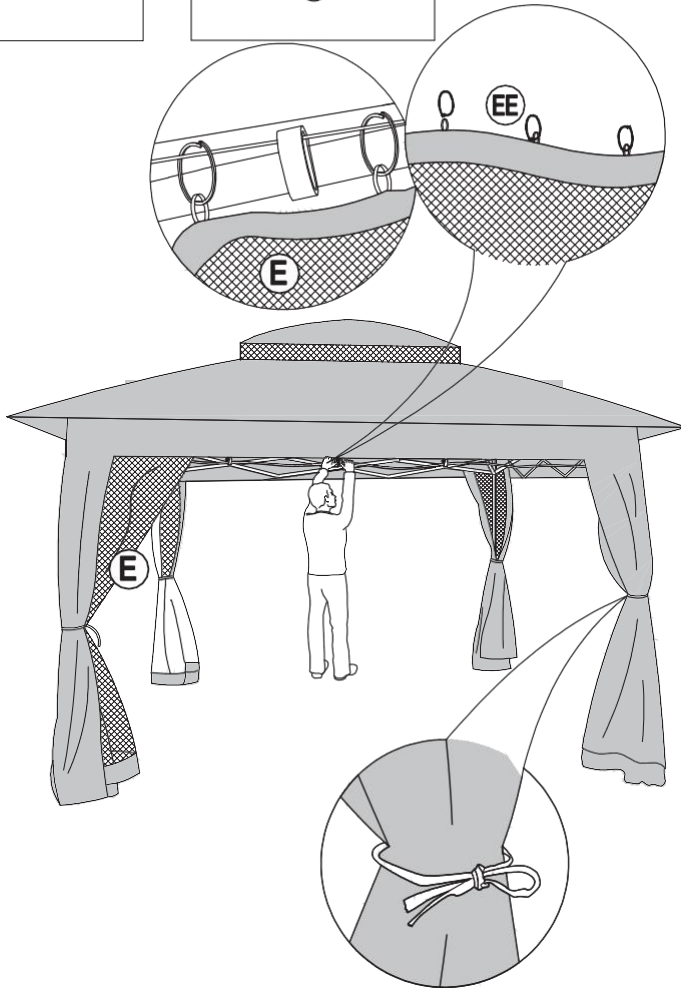
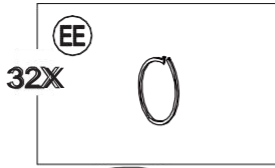
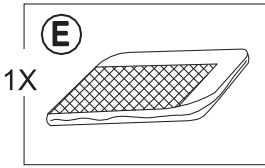

- Open the curtain rings and loop them through the sewn-in loops on the top edge of the mosquito netting.
- Secure the mosquito netting to the ropes using the curtain rings. Continue around the canopy until the entire mosquito net is secured.
- The netting/curtains can be tied back once attached.

SECURE THE CANOPY IN PLACE

Step 6

You will need:

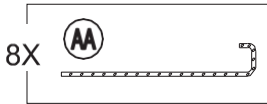

- Insert the leg skirt hook to the bottom of the canopy legs.
- Use 2pcs stakes at each foot to secure your canopy down and keep it from moving.

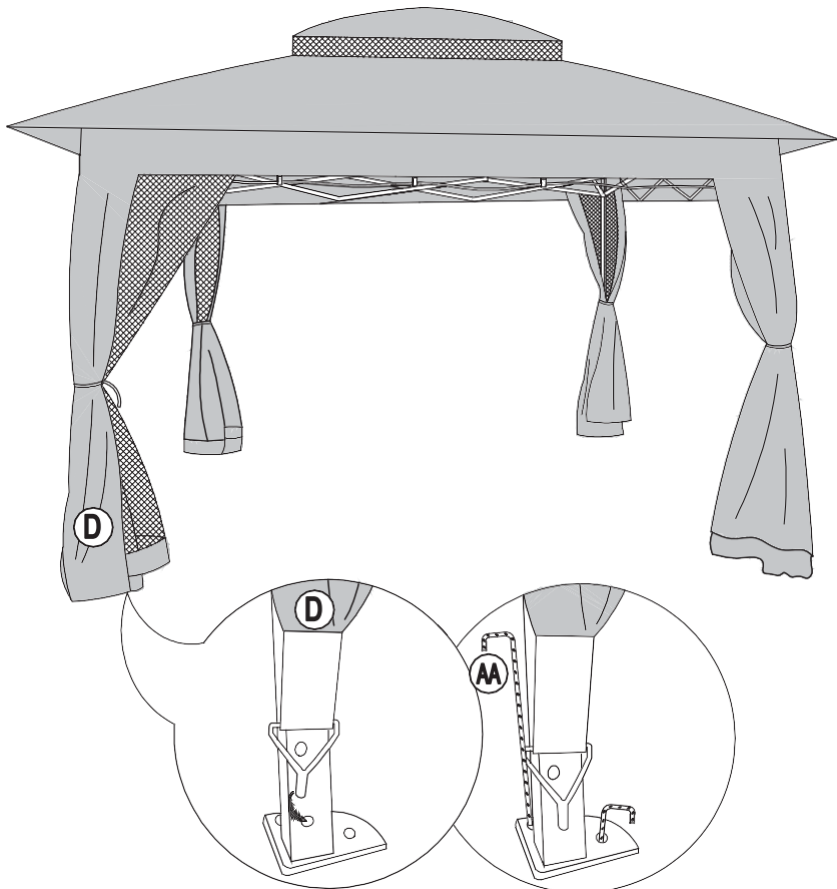

SECURE THE CANOPY IN PLACE

Step 7

You will need:

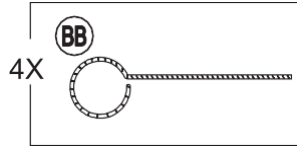
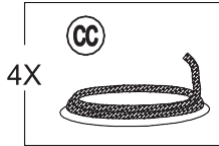

- Attach ropes at the top four corners of the canopy and secure them into the ground using the big stakes for added stability.



TAKE DOWN THE CANOPY

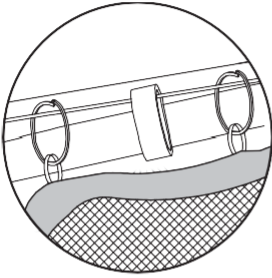

- 1** Remove the mosquito netting if attached.

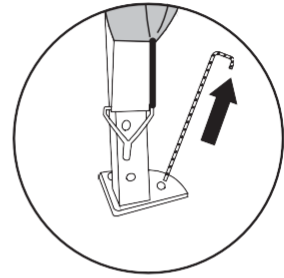

- 2** Pull up all stakes from the ground.

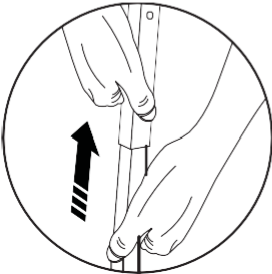

- 3** Press the push pin on each leg and retract the legs to their original height.

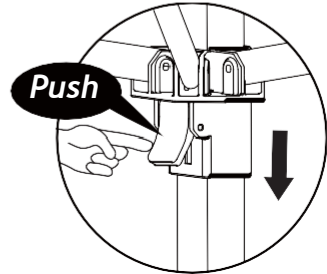

- 4** Push the push button on each slider to unlock the frame.

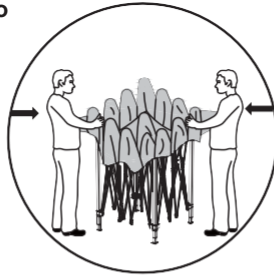

- 5** Push inward until the frame is fully closed.

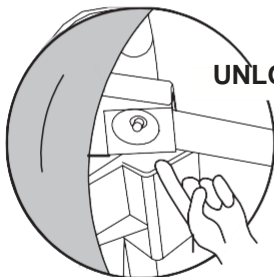

- 6** Remove the eave extender at each corner of the frame.

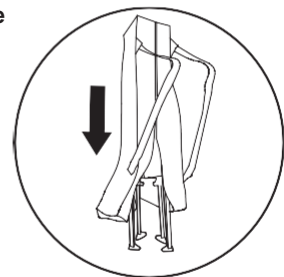

- 7** Slide the carry bag over the closed frame and close the zipper on carry bag.

REPLACEMENT PARTS

Spare Parts

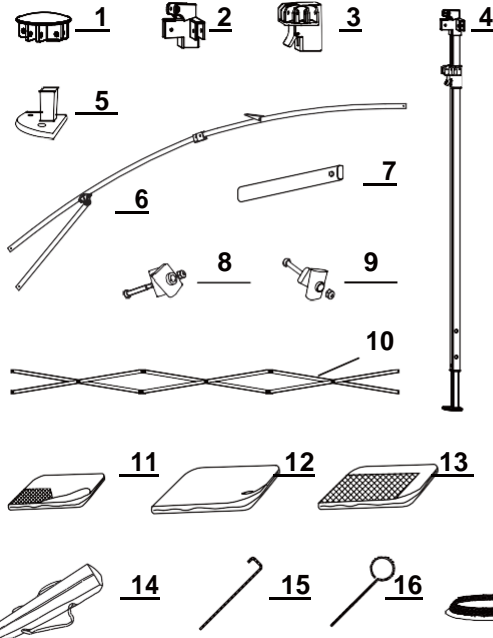
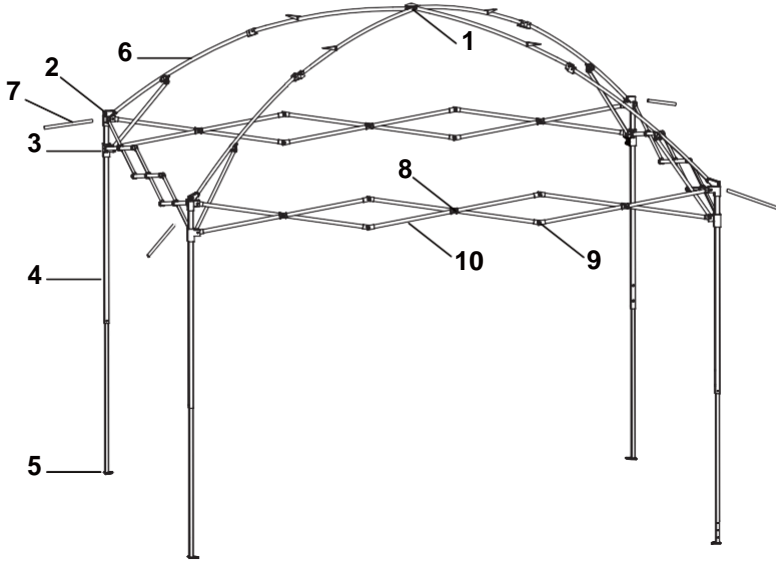

Part	Description
1	Central Cap
2	Top Cap
3	Slider
4	Leg Assembly
5	Plastic Foot
6	Ceiling Assembly
7	Eave Extender
8	Middle Bolt Kit
9	Side Bolt Kit
10	Eave Assembly
11	Small Top
12	Big Top
13	Mosquito Netting
14	Carry Bag
15	Stake
16	Big Stake
17	Rope
18	Netting Rope
19	Ring