

DESK

Assembly Instructions - Please keep for future reference

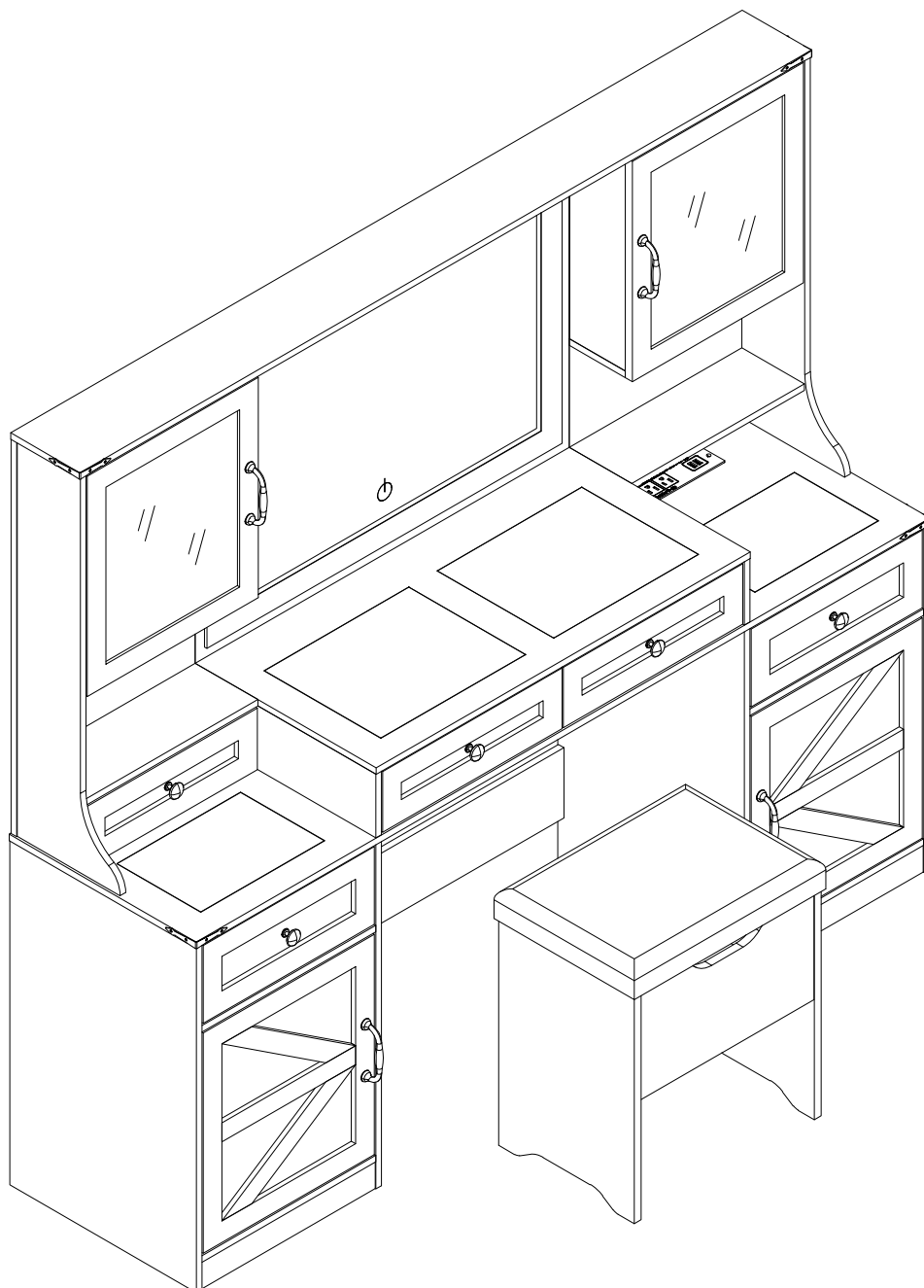

Important-Please read these instructions fully before starting assembly

Safety and Care Advice

Important – Please read these instructions fully before starting assembly

- Check you have all the components and tools listed on the following pages.
- Remove all fittings from the plastic bags and separate them
- Keep children and pets away from the installation area, which may cause choking if small parts are swallowed.
- Make sure you have enough space to layout the parts before

- Do not stand or apply weight to the product during assembly. This may cause damage.
- Assemble the item as close to its final position (in the same room) as possible.
- Assemble on a soft level surface to avoid damage to the unit or floor.
- It's easier for two people to assemble the parts together.



- To reduce the likelihood of damage to your product, make sure your power drill is set to a low torque setting.

Care and maintenance

- Only clean using a damp cloth and mild detergent, do not use bleach or abrasive cleaners.
- Check for loose screws on this unit from time to time.
- This product should not be discarded with household waste. Take to your local authority waste disposal centre.

Handy Hints

- Assemble all parts and bolts loosely during assembly, only once the product is complete should you fully tighten the bolts
- Regularly check and ensure that all bolts and fittings are correctly tightened.

WARNING In order to help prevent overturning – please follow these instructions

To help prevent product toppling over please follow the below steps:-

Use the anti tip strap or wall fixing method provided (if applicable)
Do not allow children to climb or hang on the furniture
Do not open more than one drawer at a time
Do not place heavy items in the top drawers
Do not place heavy items on top of the furniture, unless the furniture has been designed for this purpose

please note that only the anti tip strap is provided.
You will need to provide wall plugs and screws applicable for your wall type

Using Camlocks

Step 1

Connect the male camlock as directed in the assembly instructions using a screwdriver.

1 DO NOT OVER TIGHTEN.

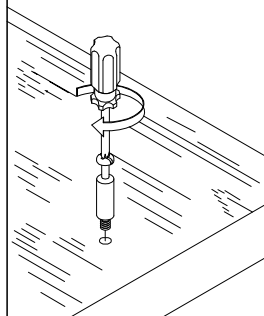

Step 2

Push the male camlock into the entry hole.

2

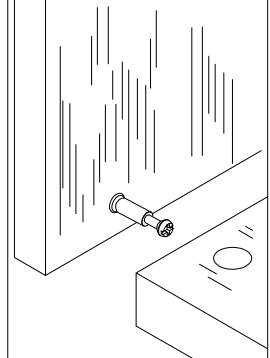

Step 3

Insert the female camlock as shown in the instruction.

Note: ensure that the arrow on the top of the camlock points towards the entry hole for the male camlock.

3

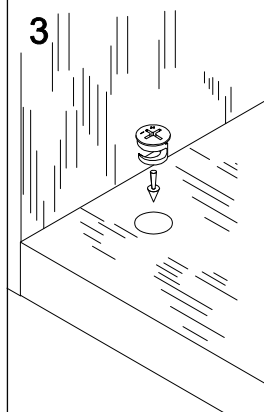

Step 4

Turn the female camlock clockwise with a screwdriver.

You should feel a click when the camlock is locked in place.

The joint is now secure.



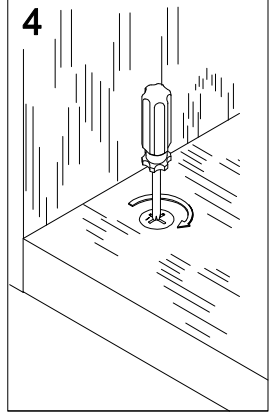

4

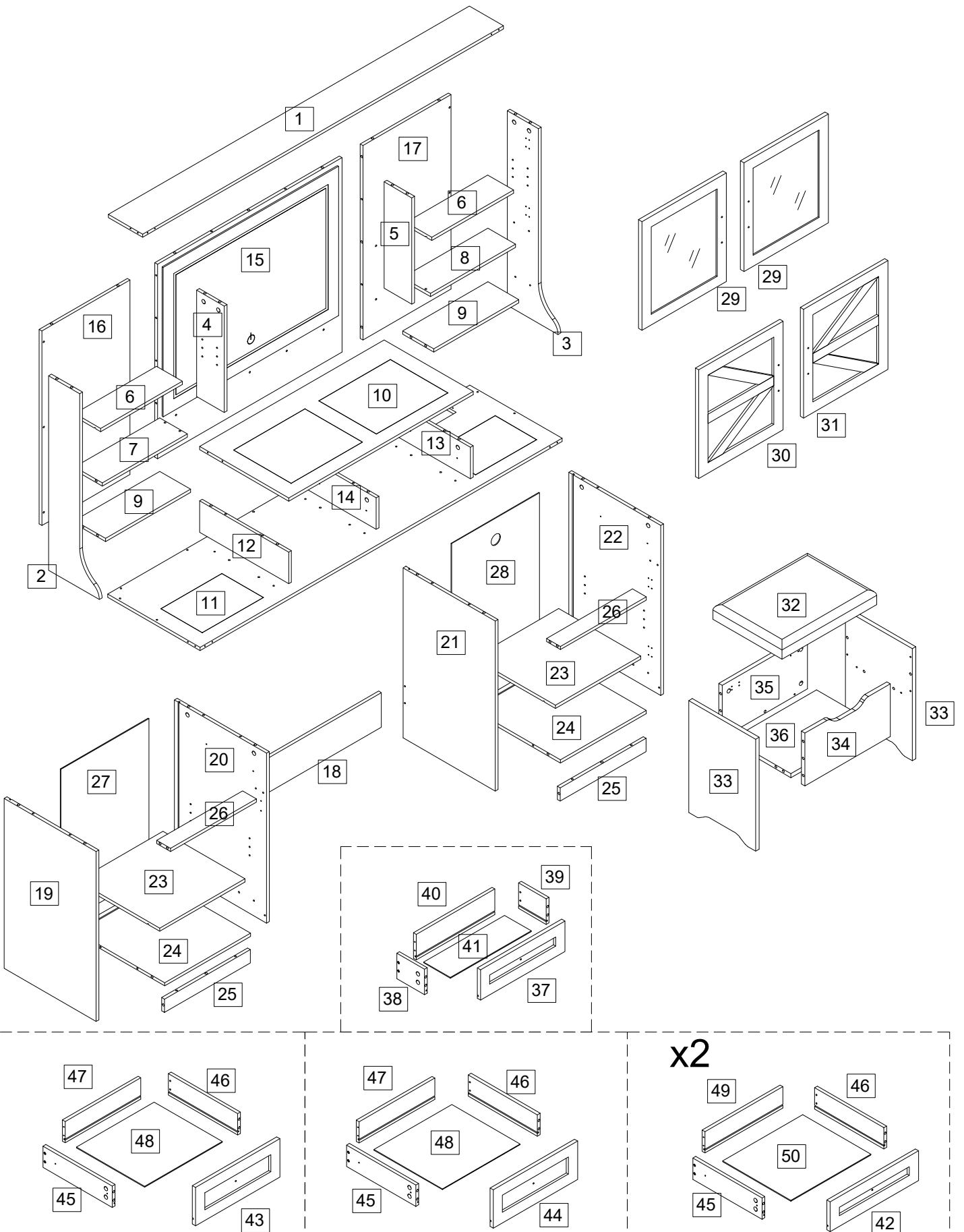



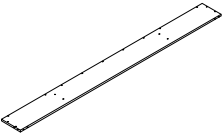
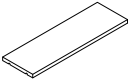
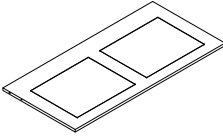
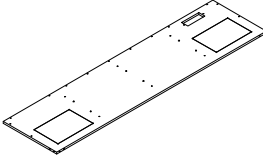
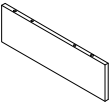
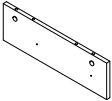
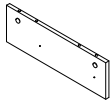
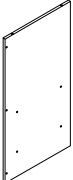

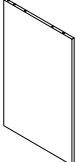
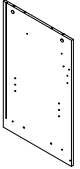
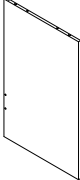
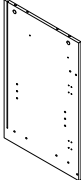
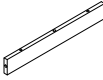
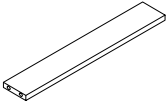
Assembly Instructions

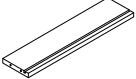



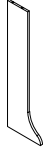
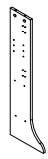

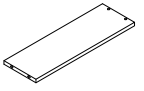
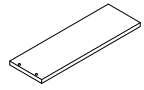
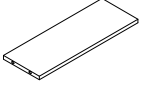
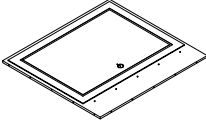
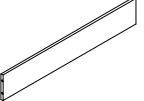
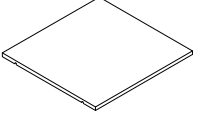
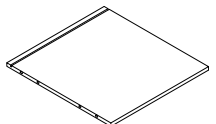
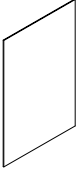

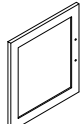
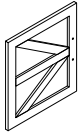
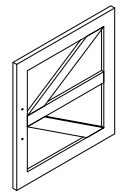
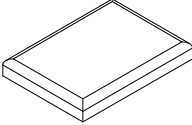
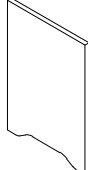
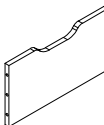
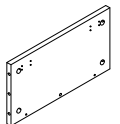
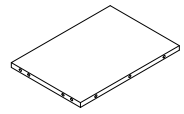
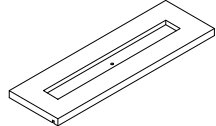
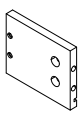
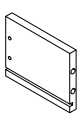
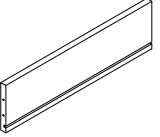
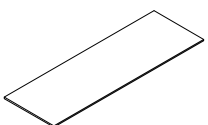
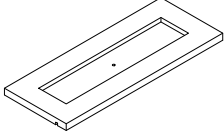
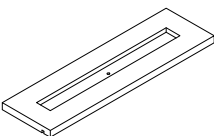
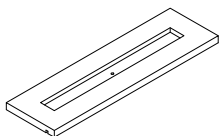
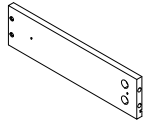
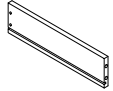
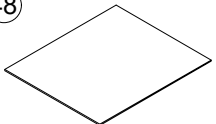
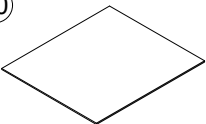
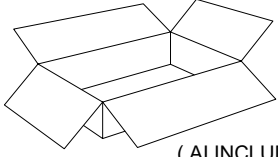





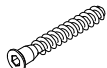

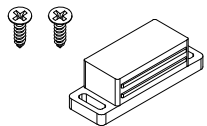
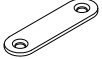

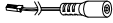
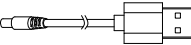

Part List:

<p>①</p>  <p>1 pc</p>	<p>⑥</p>  <p>2 pcs</p>	<p>⑩</p>  <p>1 pc</p>	<p>⑪</p>  <p>1 pc</p>	<p>⑫</p>  <p>1 pc</p>
<p>⑬</p>  <p>1 pc</p>	<p>⑭</p>  <p>1 pc</p>	<p>⑯</p>  <p>1 pc</p>	<p>⑰</p>  <p>1 pc</p>	<p>⑲</p>  <p>1 pc</p>
<p>⑳</p>  <p>1 pc</p>	<p>㉑</p>  <p>1 pc</p>	<p>㉒</p>  <p>1 pc</p>	<p>㉕</p>  <p>2 pcs</p>	<p>㉖</p>  <p>2 pcs</p>
<p>④⑦</p>  <p>2 pcs</p>	<p>④⑨</p>  <p>2 pcs</p>			

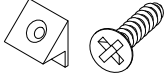
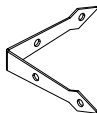
Part List:

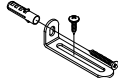
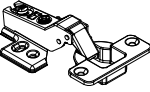
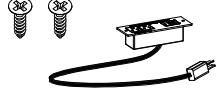
<p>②</p>  <p>1 pc</p>	<p>③</p>  <p>1 pc</p>	<p>④</p>  <p>1 pc</p>	<p>⑤</p>  <p>1 pc</p>	<p>⑦</p>  <p>1 pc</p>
<p>⑧</p>  <p>1 pc</p>	<p>⑨</p>  <p>2 pcs</p>	<p>⑮</p>  <p>1 pc</p>	<p>⑱</p>  <p>1 pc</p>	<p>⑳</p>  <p>2 pcs</p>
<p>⑳</p>  <p>2 pcs</p>	<p>㉓</p>  <p>1 pc</p>	<p>㉔</p>  <p>1 pc</p>	<p>㉕</p>  <p>2 pcs</p>	<p>㉖</p>  <p>1 pc</p>
<p>㉙</p>  <p>1 pc</p>	<p>㉚</p>  <p>1 pc</p>	<p>㉛</p>  <p>2 pcs</p>	<p>㉜</p>  <p>1 pc</p>	<p>㉝</p>  <p>1 pc</p>
<p>㉞</p>  <p>1 pc</p>	<p>㉟</p>  <p>1 pc</p>	<p>㊱</p>  <p>1 pc</p>	<p>㊲</p>  <p>1 pc</p>	<p>㊳</p>  <p>1 pc</p>
<p>㊴</p>  <p>1 pc</p>	<p>㊵</p>  <p>2 pcs</p>	<p>㊶</p>  <p>1 pc</p>	<p>㊷</p>  <p>1 pc</p>	<p>㊸</p>  <p>4 pcs</p>
<p>㊹</p>  <p>4 pcs</p>	<p>㊺</p>  <p>2 pcs</p>	<p>㊻</p>  <p>2 pcs</p>	 <p>Hardware (AI INCLUDED BOX-N704P287838K)</p>	

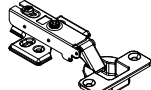
Hardware list

<p>A </p> <p>Male Camlock x 109</p>	<p>B </p> <p>Female Camlock x 109</p>	<p>C </p> <p>6*30Dowel x 42</p>
<p>D </p> <p>5*38mm Screw x 38</p>	<p>E </p> <p>3.5*12mm Screw x 32</p>	<p>F </p> <p>4*35mm Screw x 20</p>
<p>G </p> <p>x 2</p>	<p>H </p> <p>x 2</p>	<p>I </p> <p>Handle x 5</p>
<p>J </p> <p>Handle x 4</p>	<p>K </p> <p>4*18mm Screw x 8</p>	<p>L </p> <p>Hex Key M3 x 1</p>
<p>M </p> <p>x16</p>	<p>N </p> <p>x1</p>	<p>O </p> <p>x1</p>
<p>P </p> <p>4*12mm Screw x 16</p>	<p>Q </p> <p>3.5*14mm Screw x 64</p>	<p>R </p> <p>x8</p>
<p>S </p> <p>x4</p>	<p>T </p> <p>4*8mm Screw x 5</p>	<p>U </p> <p>x4</p>
<p>V </p> <p>Wall Fixing Pack x 2</p>	<p>W </p> <p>x8</p>	<p>X </p> <p>x1</p>
<p>Y </p> <p>Drawer slider 12" x 4</p>	<p>Z </p> <p>x2</p>	<p>1A </p> <p>8*30Dowel x 10</p>

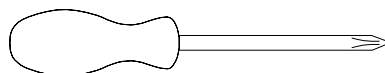

Assembly Tools Required (Not Included)

Assembly Instructions

Step 1

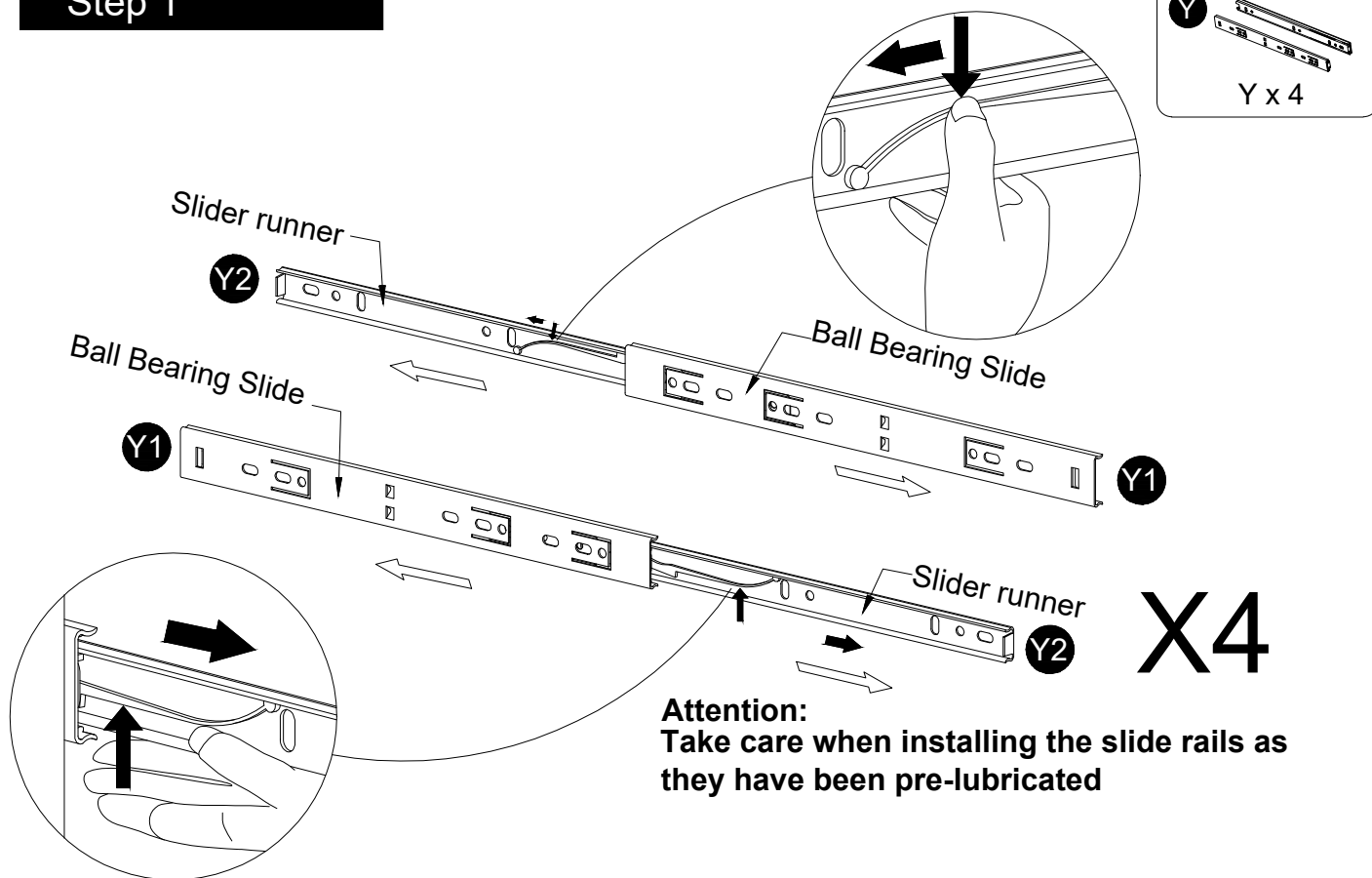

Step 2

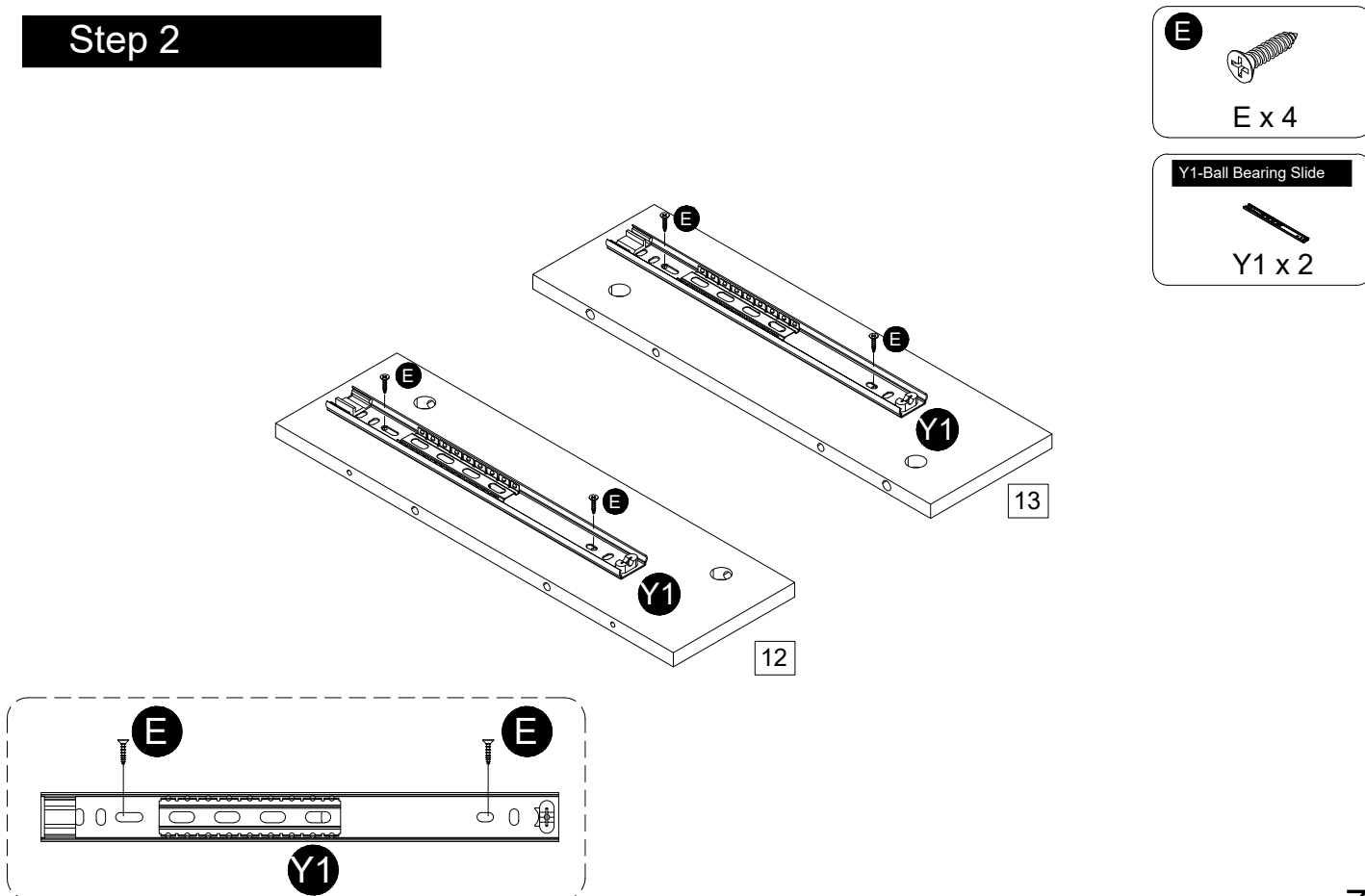

Assembly Instructions

Step 3

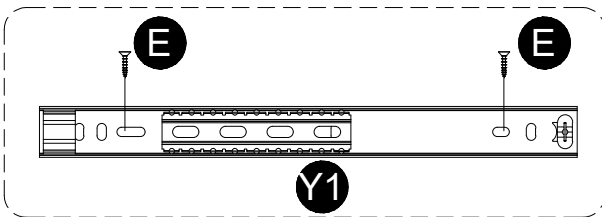
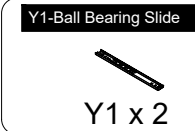
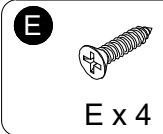
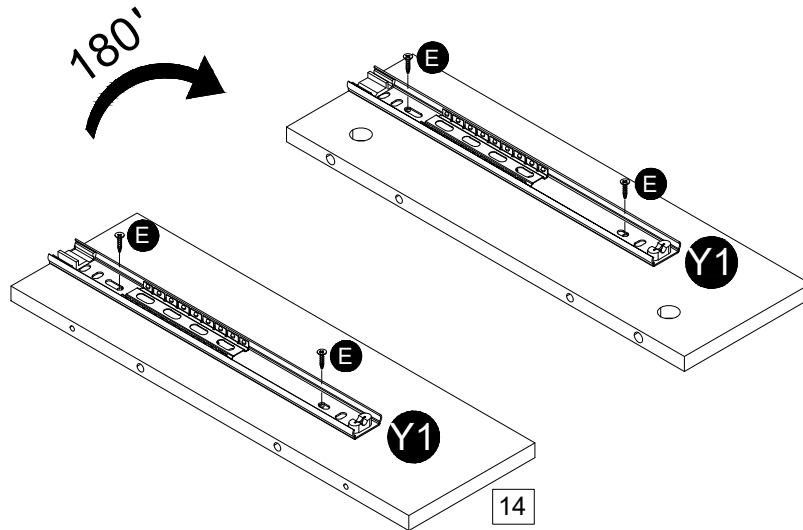

Step 4

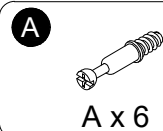
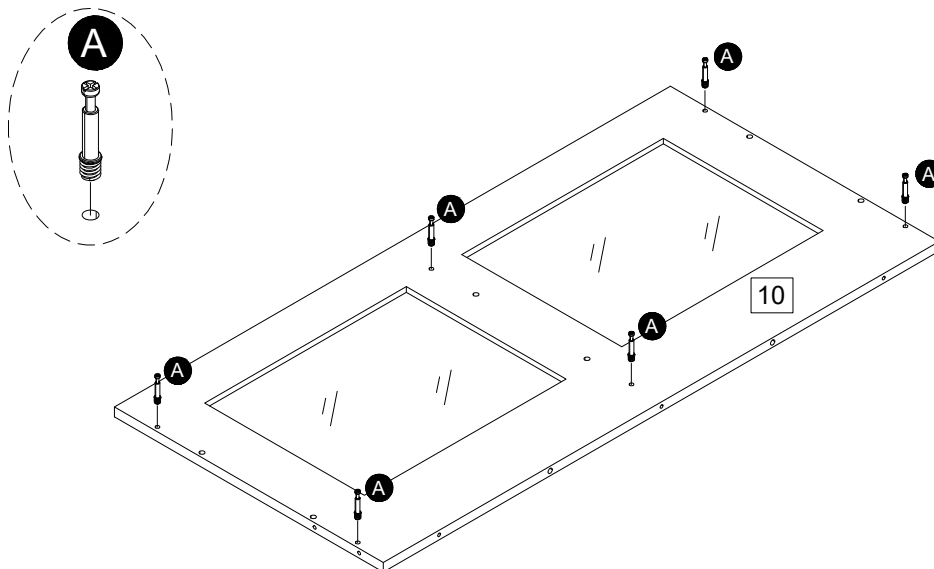

Assembly Instructions

Step 5

"Need to rotate and tighten B"

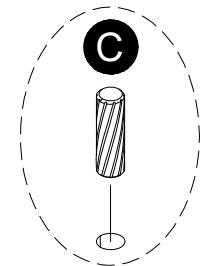
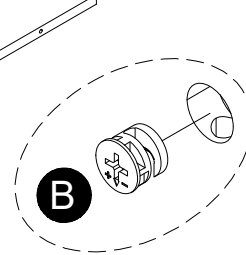
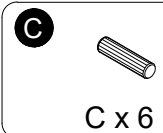
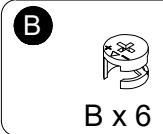
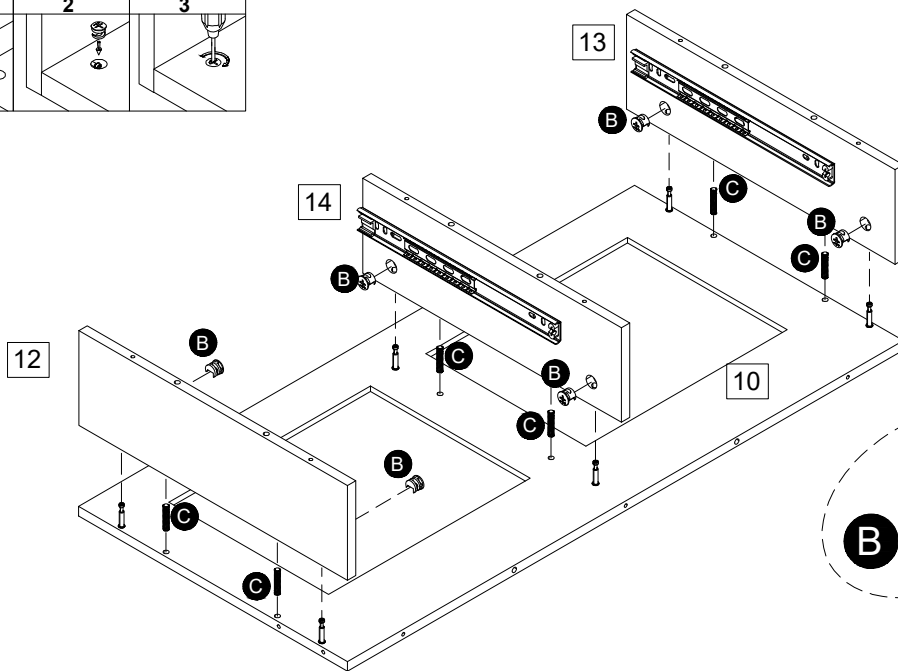
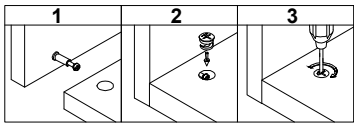

Step 6

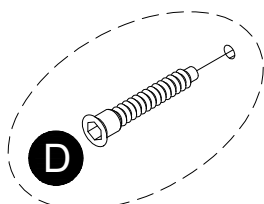
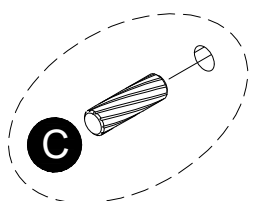
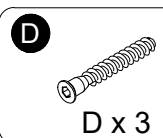
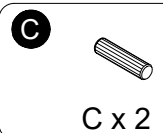
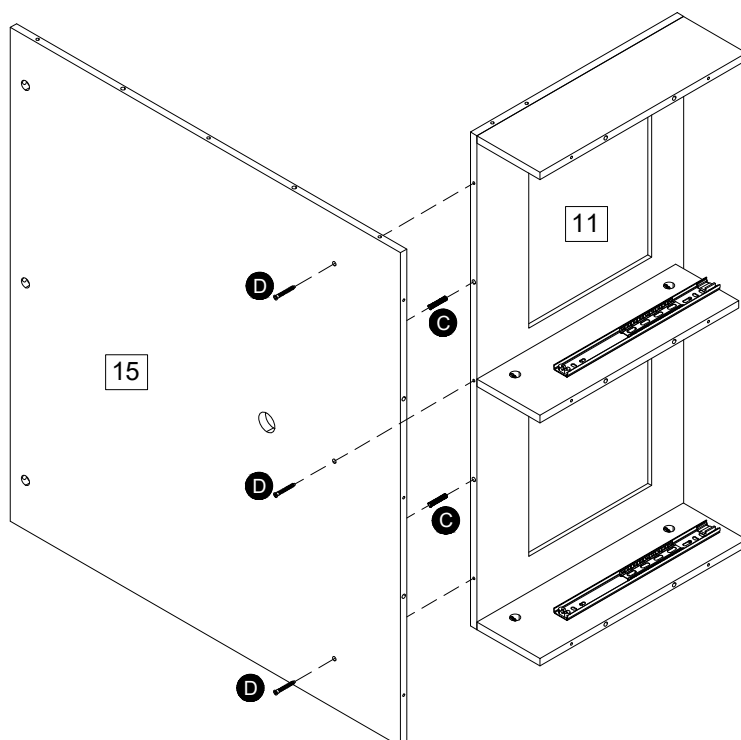

Assembly Instructions

Step 7

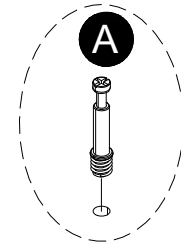
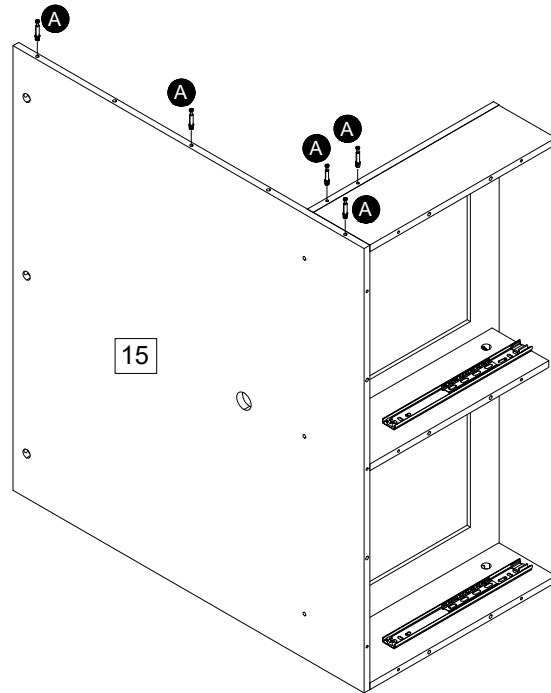
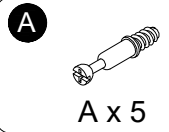

Step 8

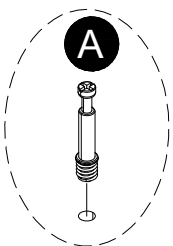
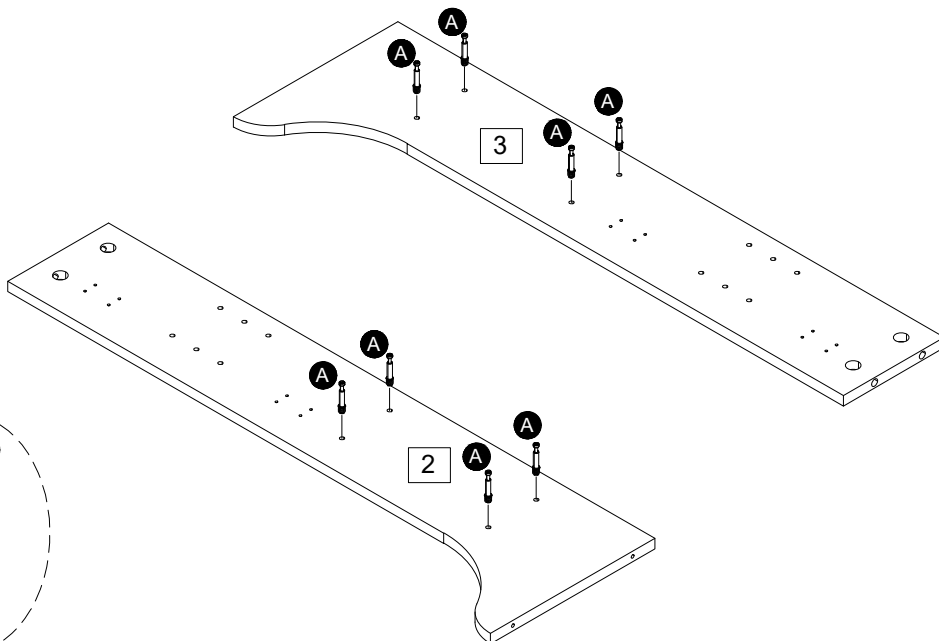
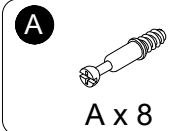

Assembly Instructions

Step 9

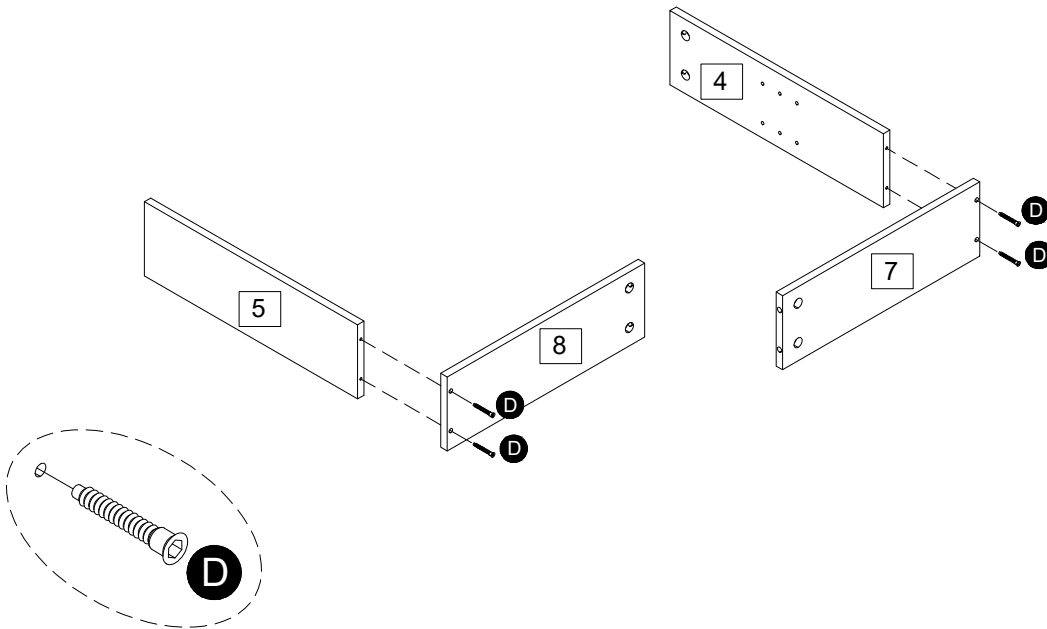
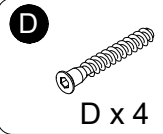

Step 10

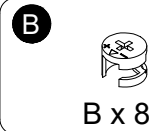

"Need to rotate and tighten B"

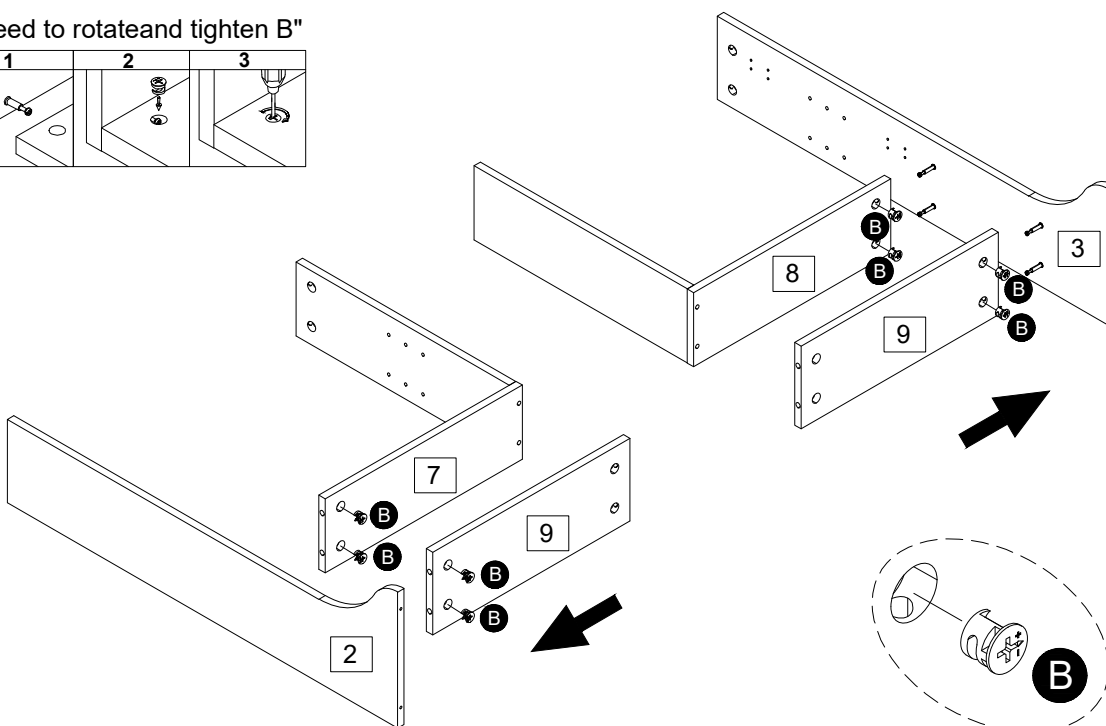
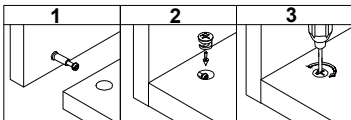

Assembly Instructions

Step 11

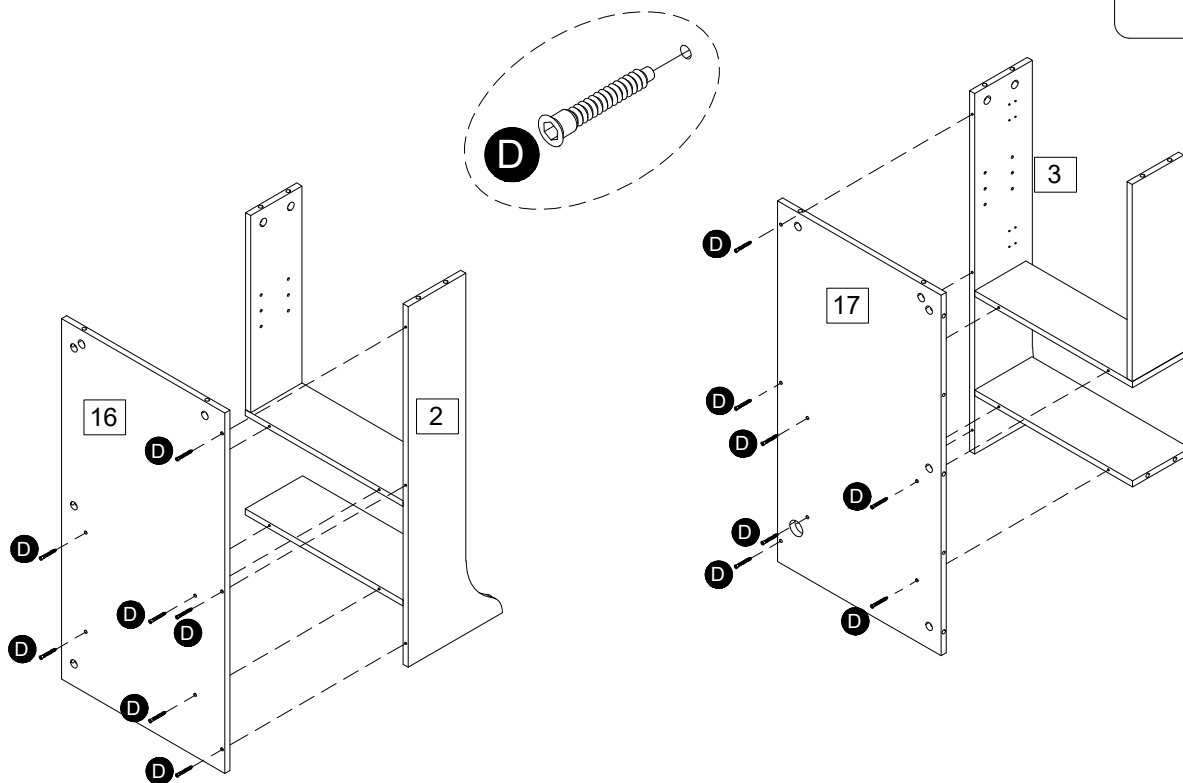
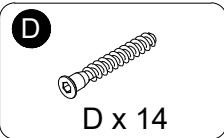

Step 12

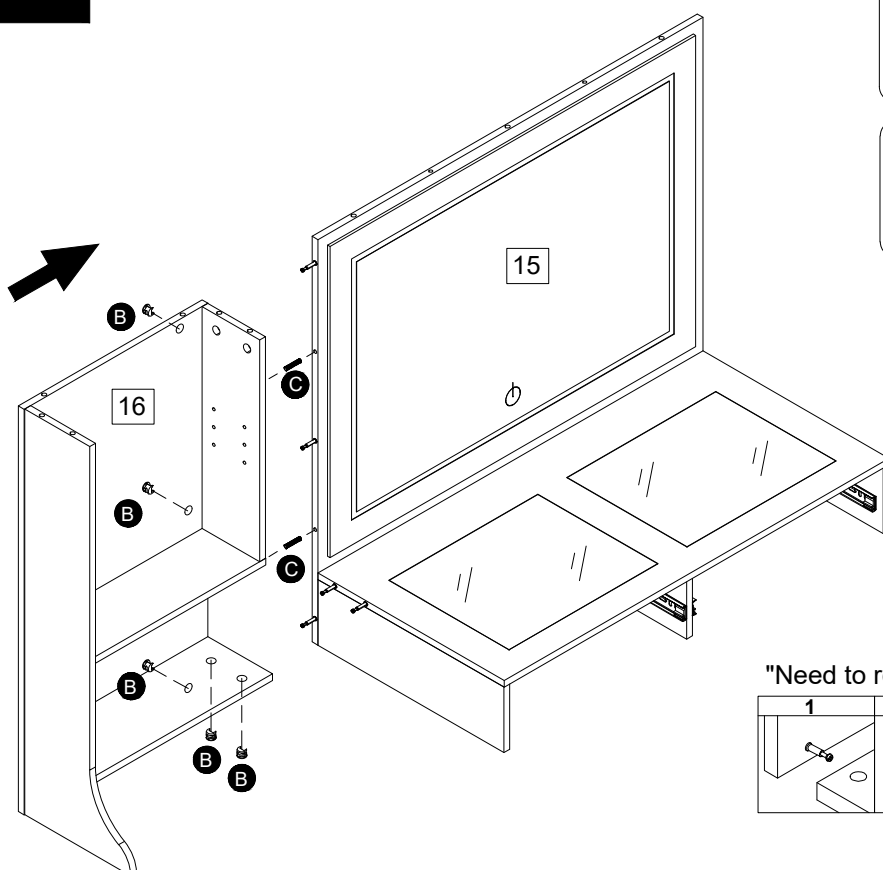
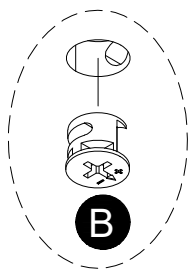
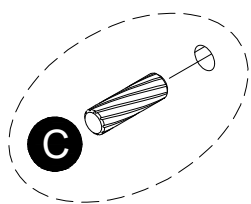
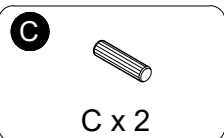
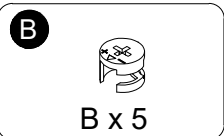

"Need to rotate and tighten B"

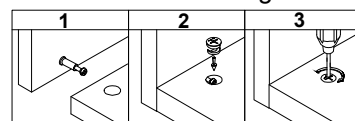

Assembly Instructions

Step 13

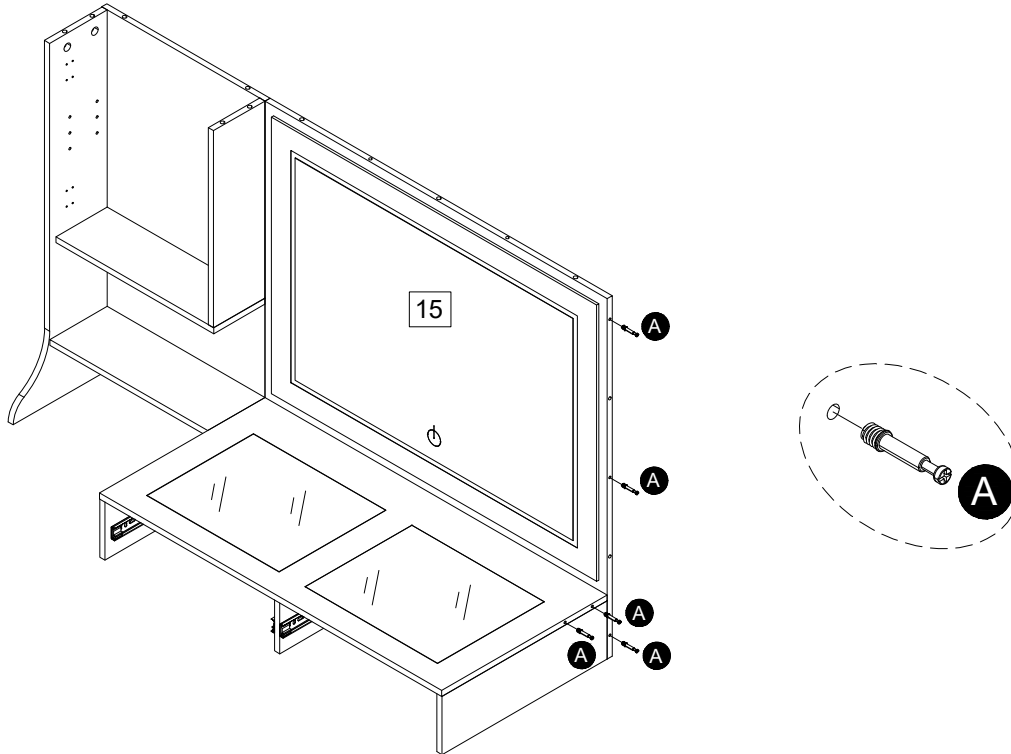
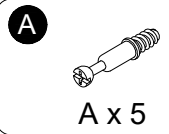

Step 14

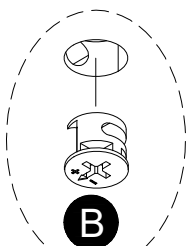
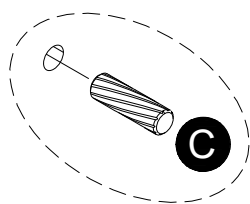
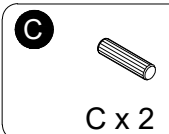
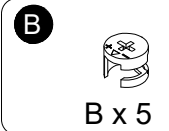

"Need to rotate and tighten B"

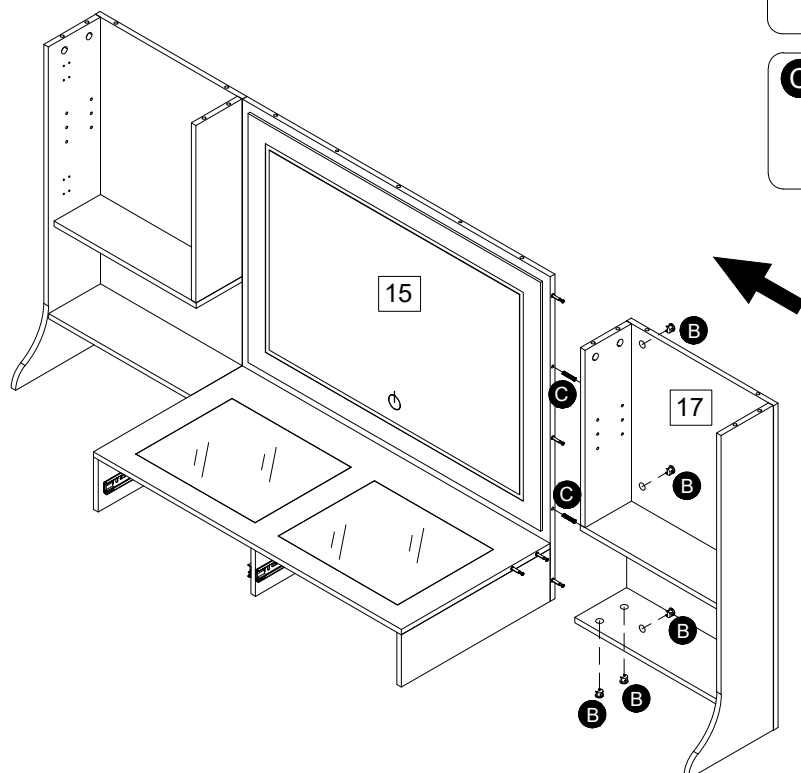
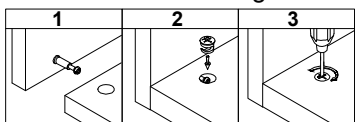

Assembly Instructions

Step 15

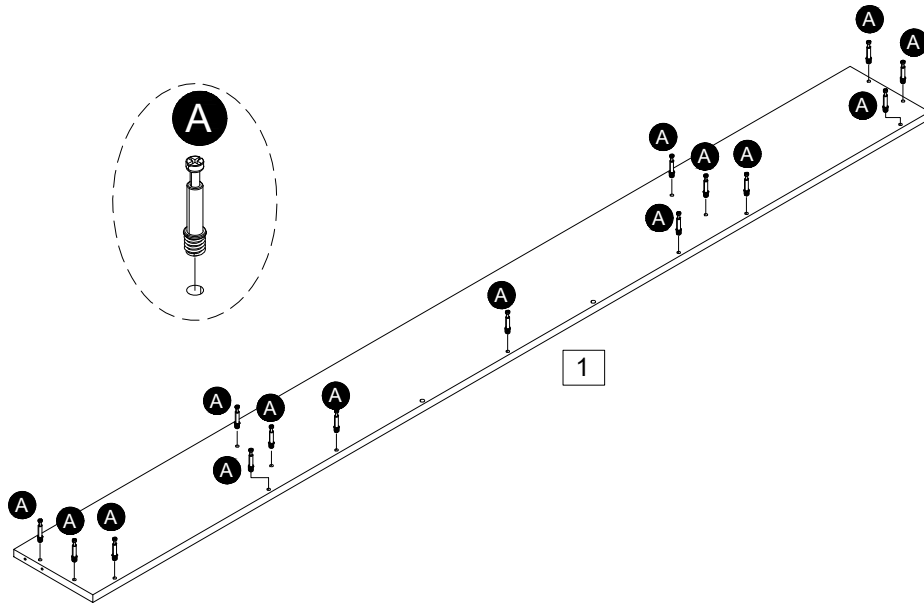
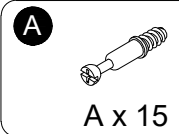

Step 16

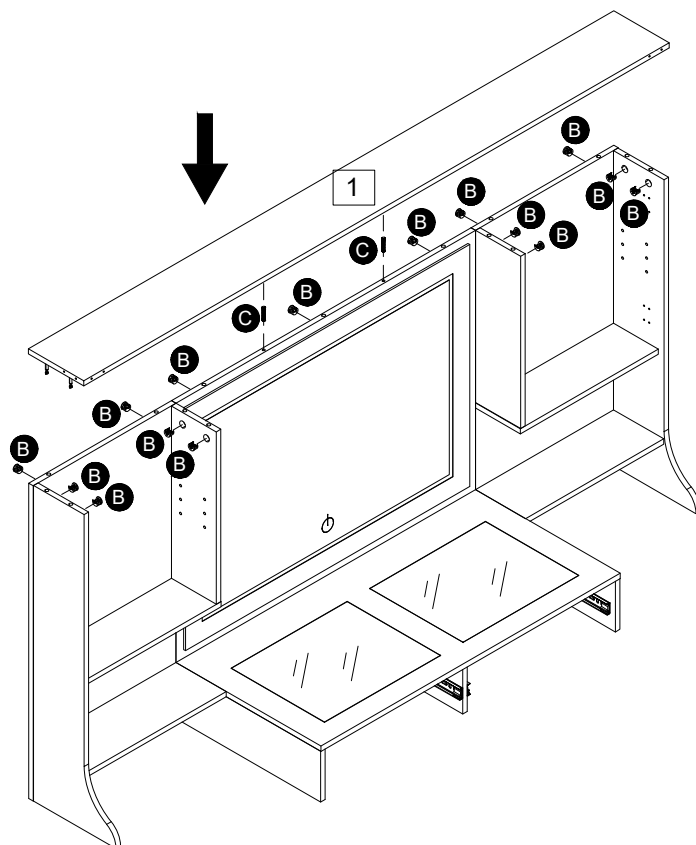
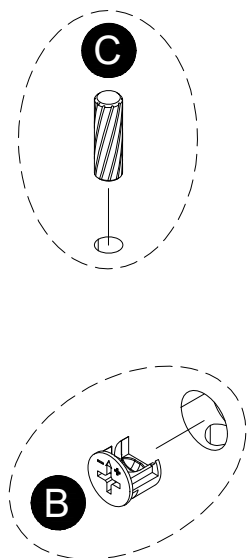
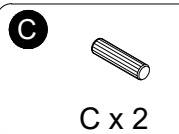

"Need to rotate and tighten B"

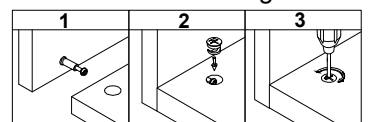

Assembly Instructions

Step 17

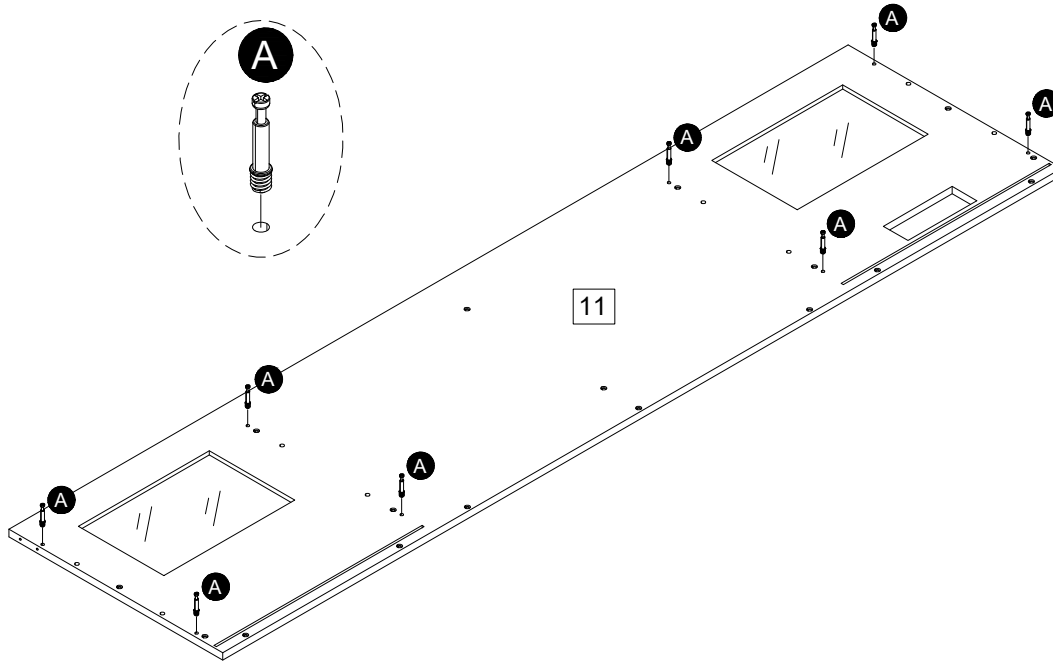
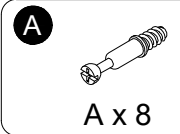

Step 18

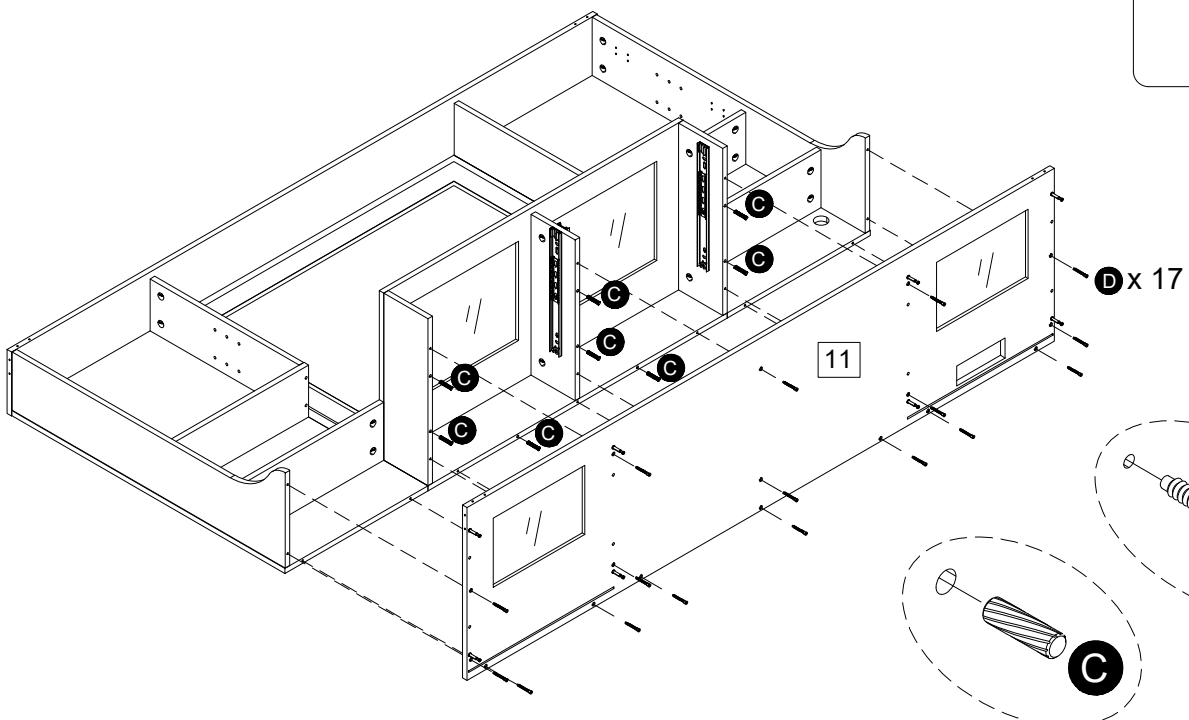
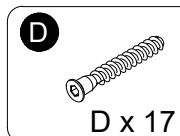
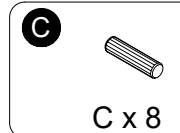

Assembly Instructions

Step 19

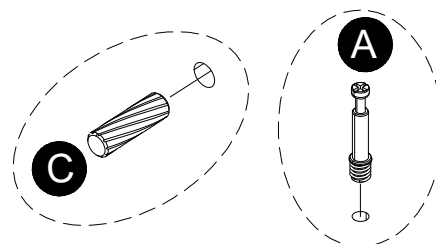
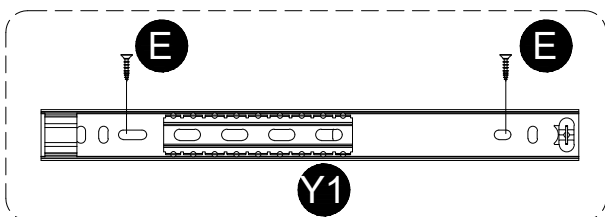
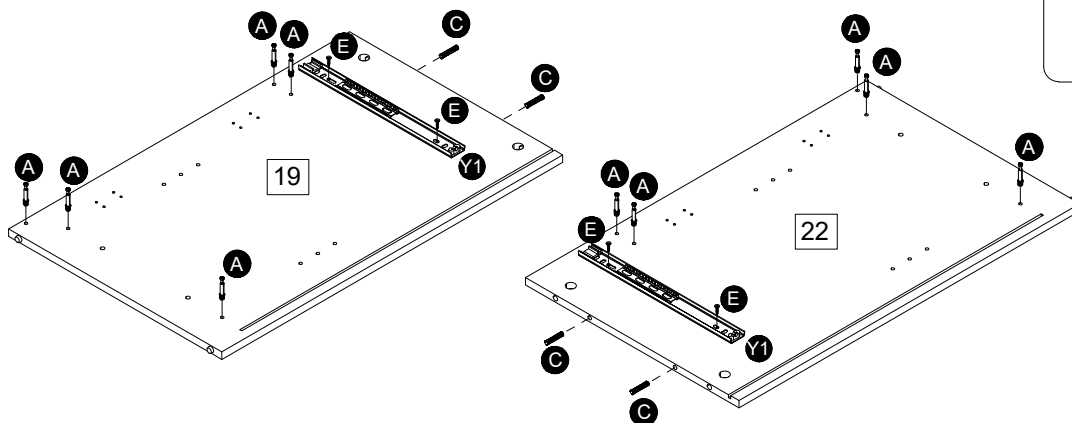
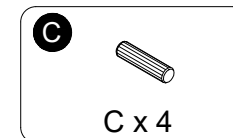
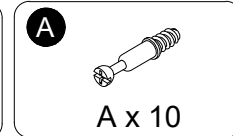
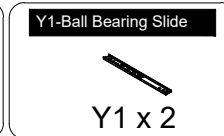
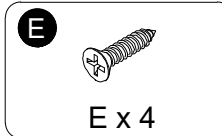

Step 20

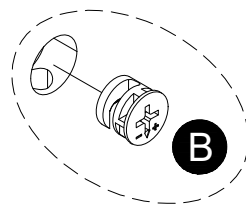
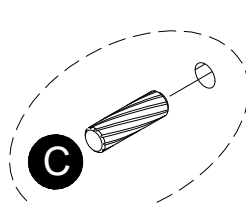
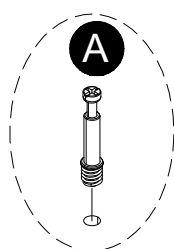
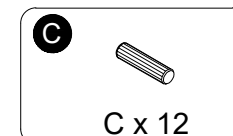
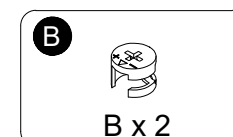
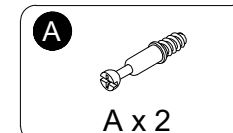

"Need to rotate and tighten B"

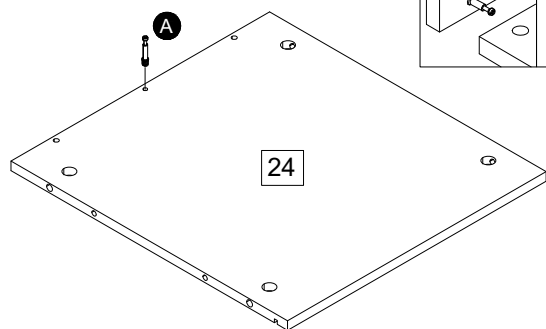
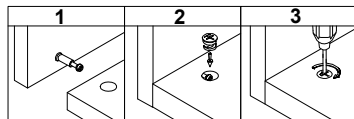

x 2

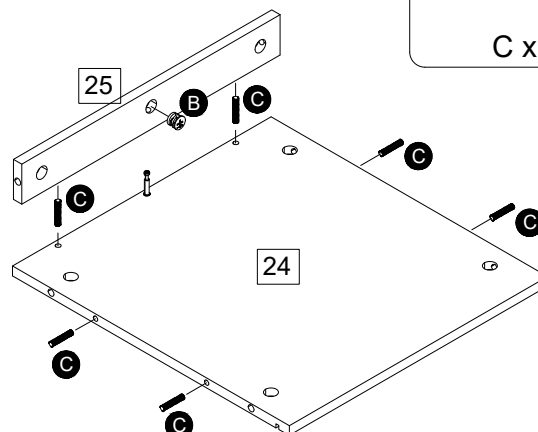

x 2

Assembly Instructions

Step 21

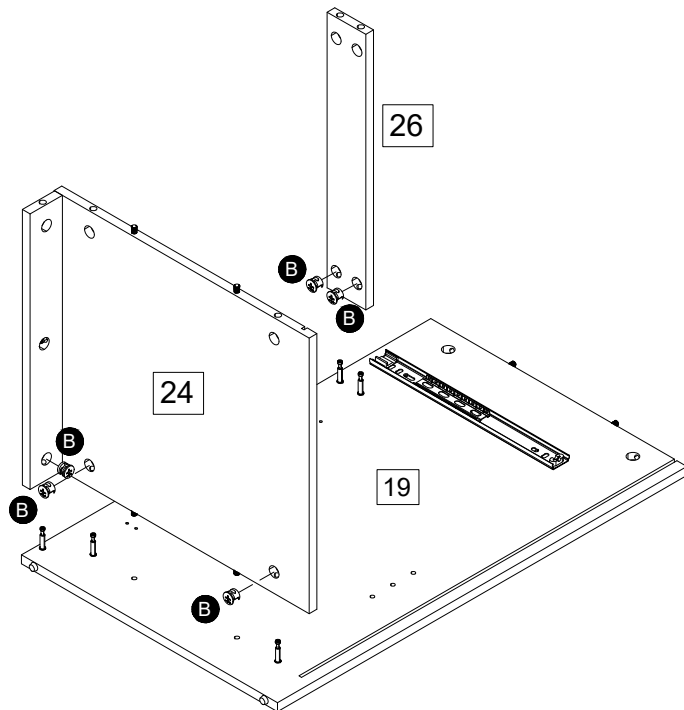
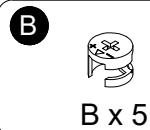

"Need to rotate and tighten B"

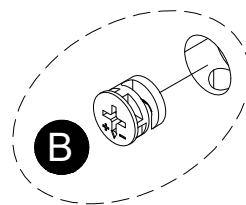
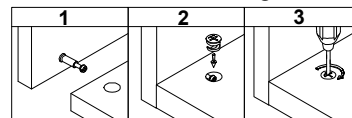

Step 22

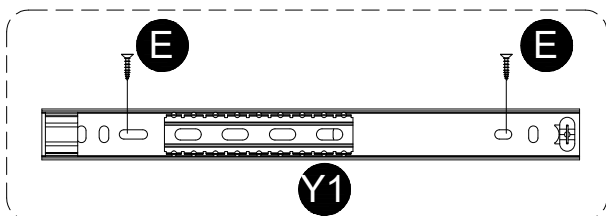
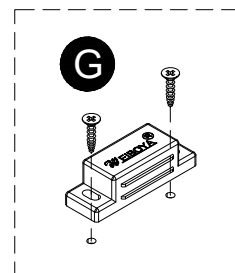
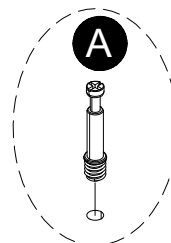
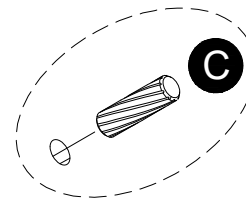
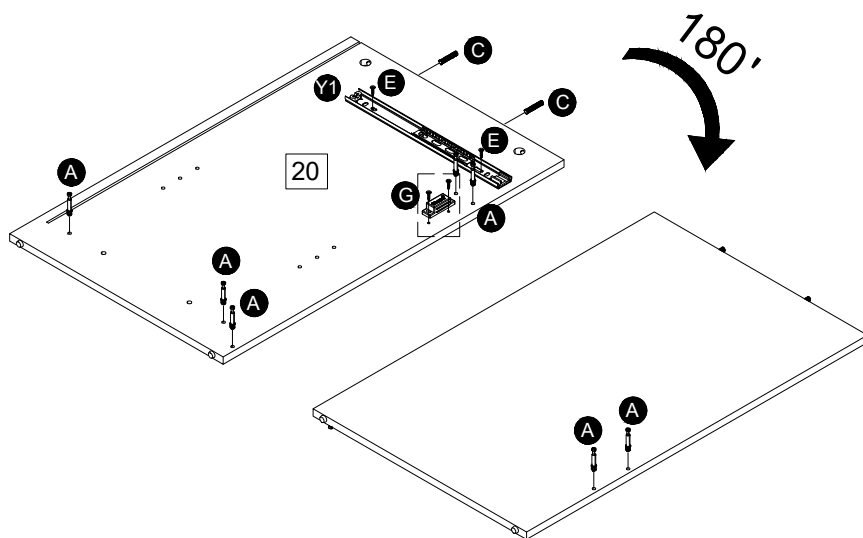
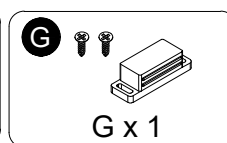
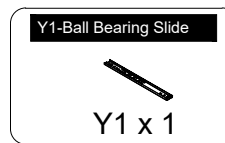
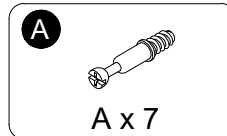
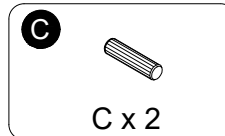
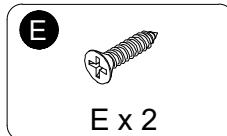

Assembly Instructions

Step 23

B



B x 5

"Need to rotate and tighten B"

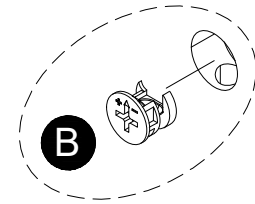
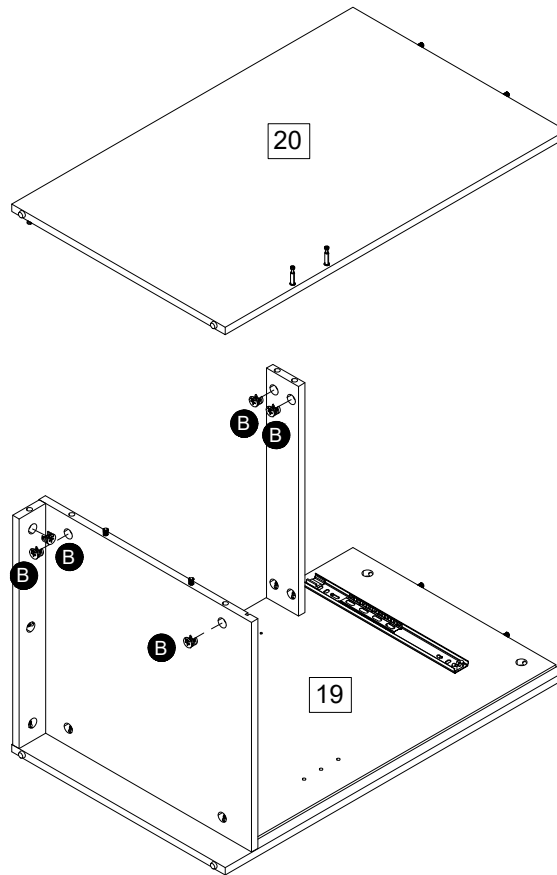
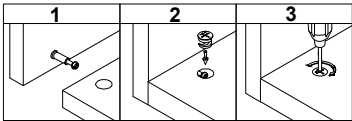

Step 24

B



B x 5

"Need to rotate and tighten B"

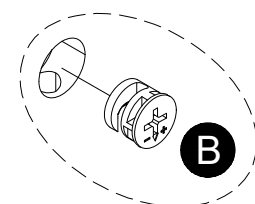
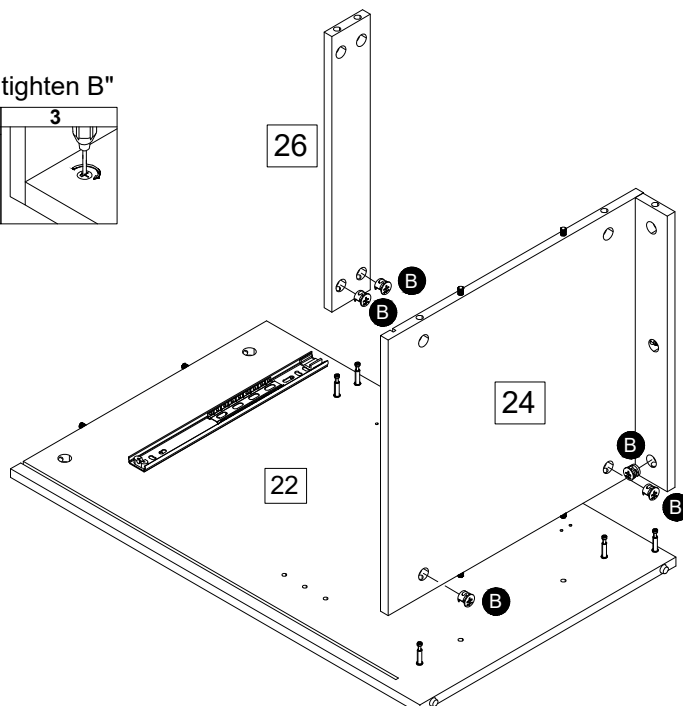
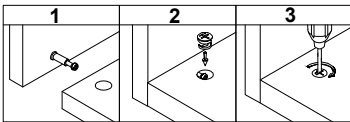

Assembly Instructions

Step 25

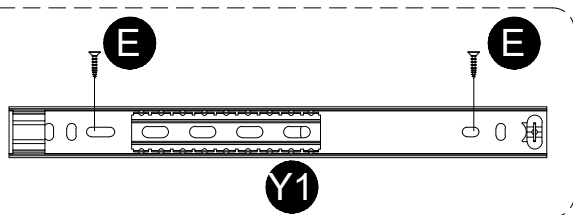
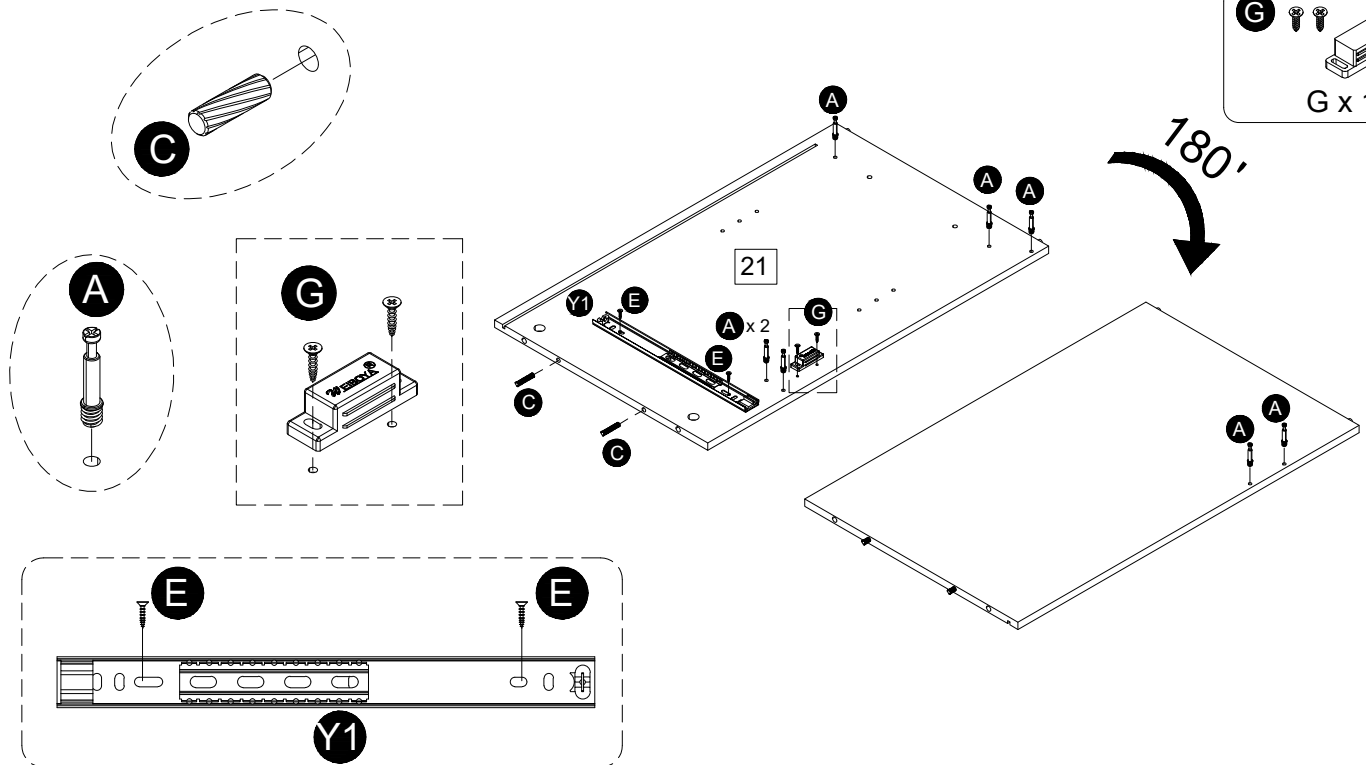
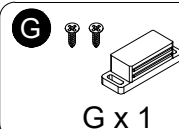
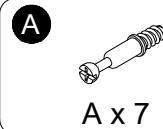
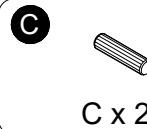
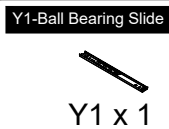
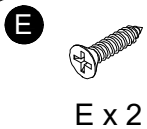

Step 26

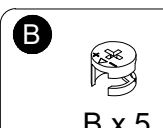

"Need to rotate and tighten B"

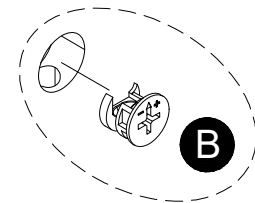
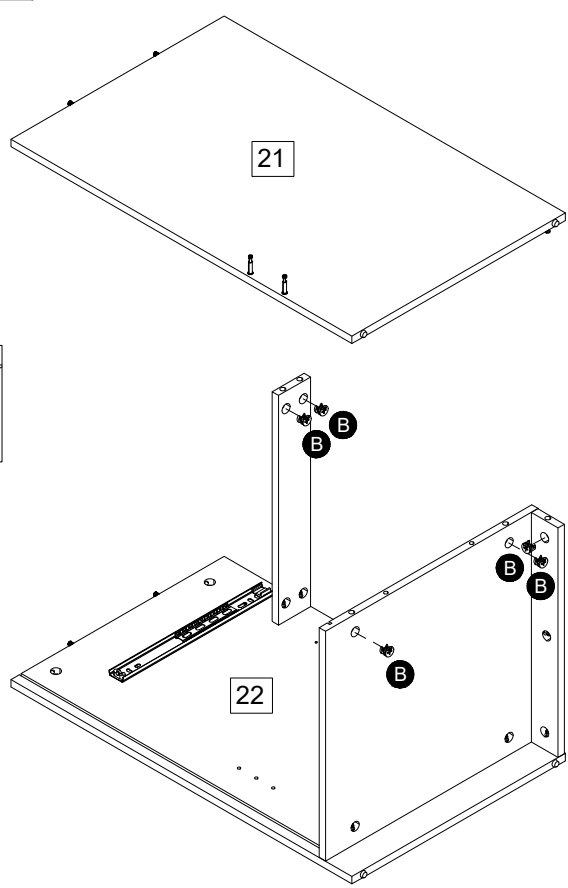
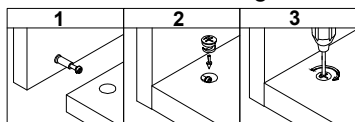

Assembly Instructions

Step 27

B



B x 4

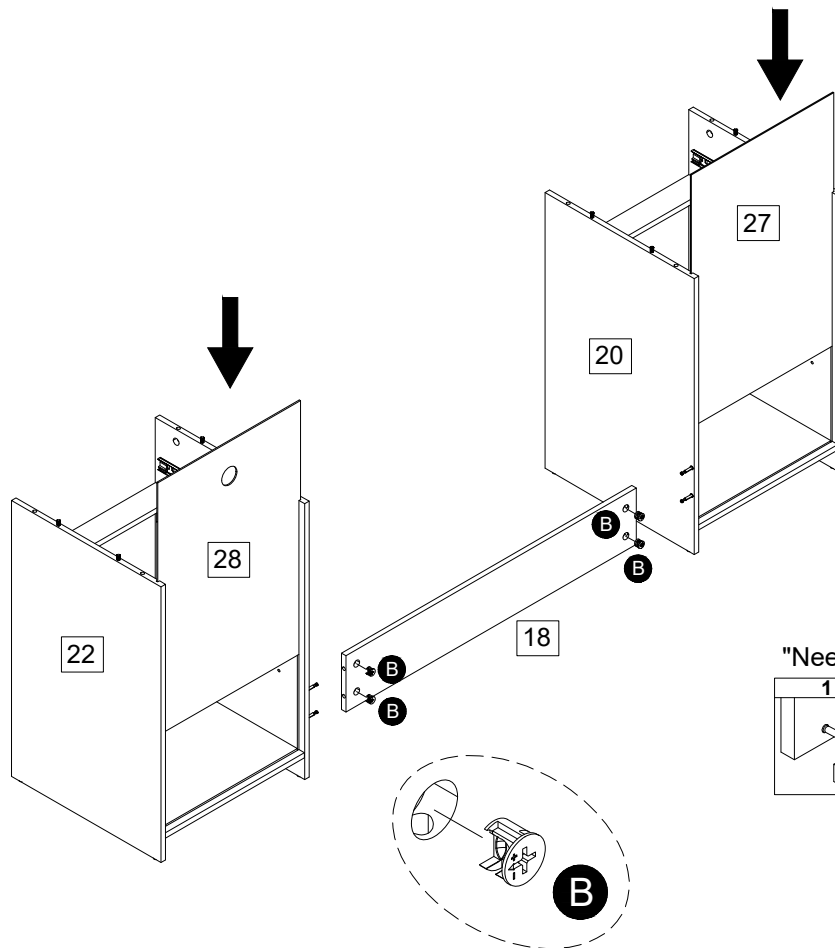

"Need to rotate and tighten B"

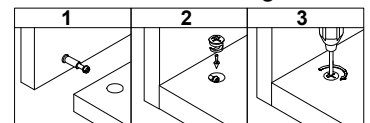

Assembly Instructions

Step 28

B



B x 8

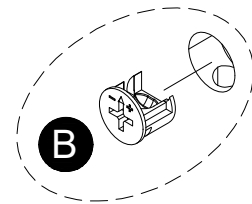
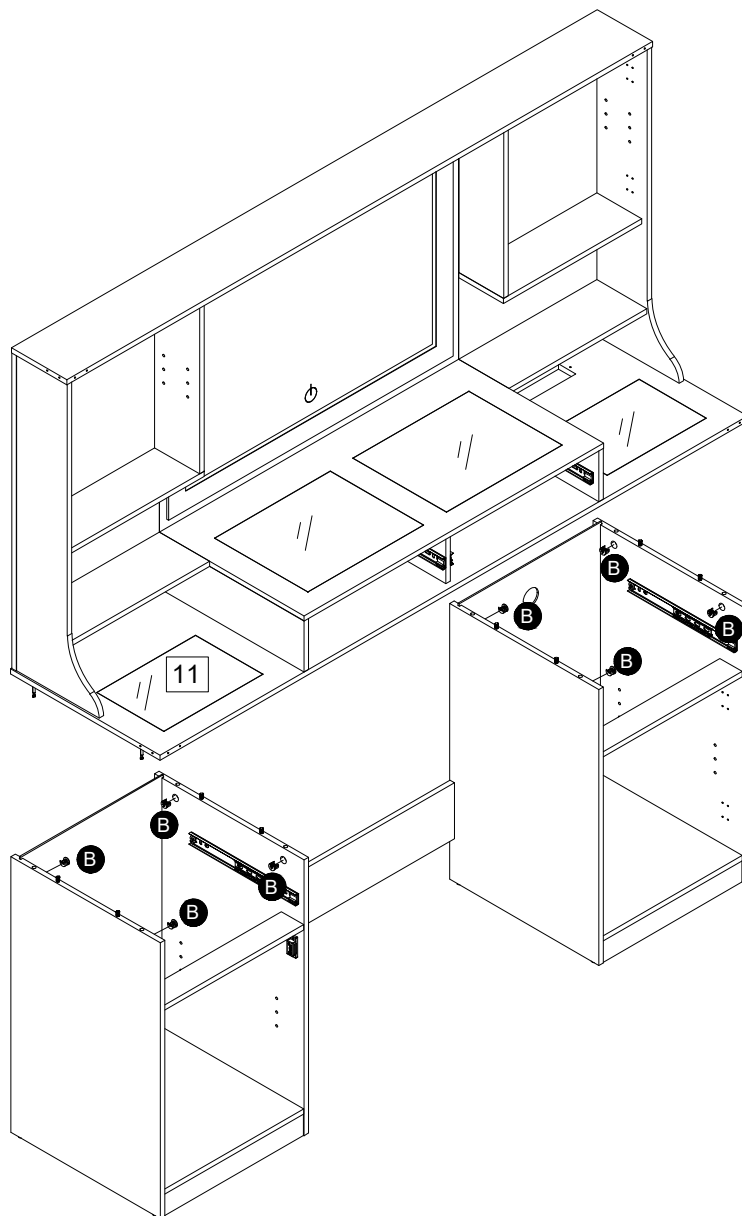

"Need to rotate and tighten B"

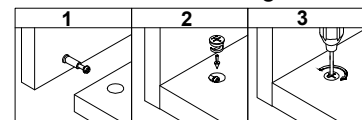

Assembly Instructions

Step 29

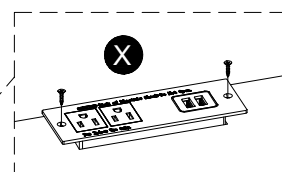
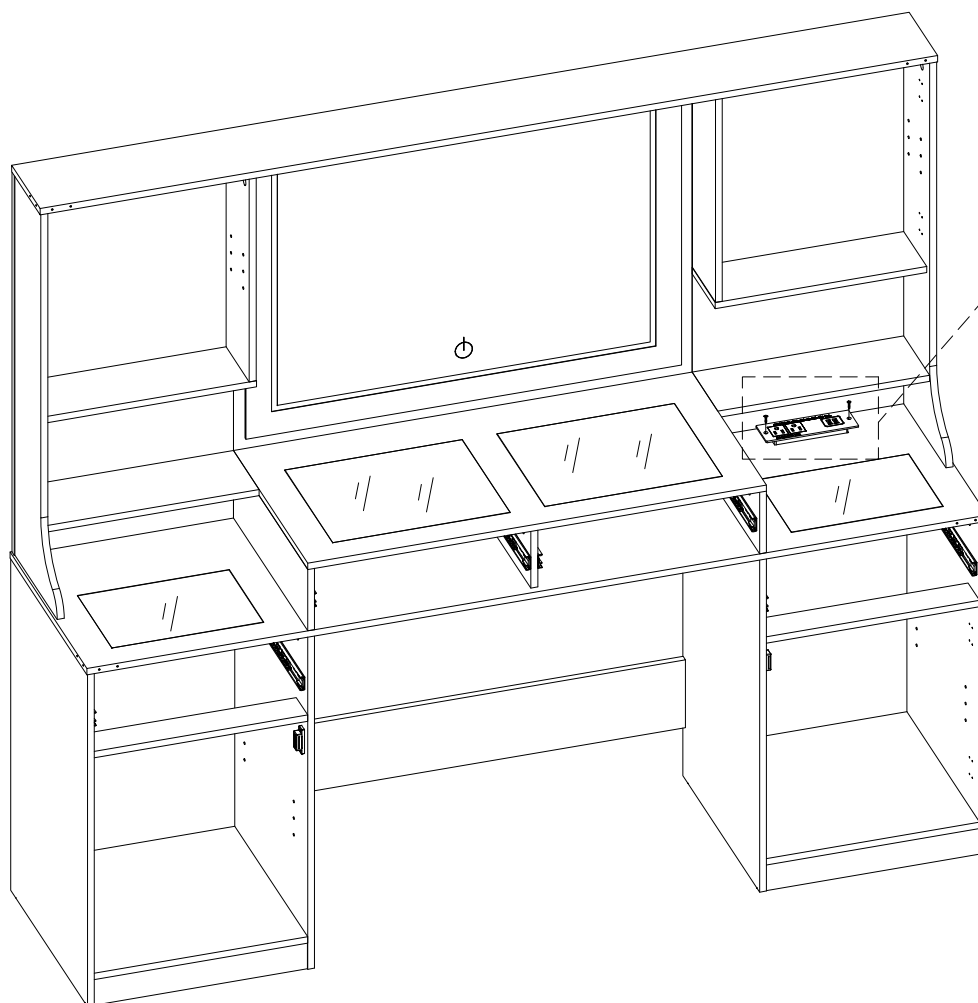
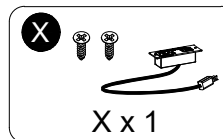

Assembly Instructions

Step 30

M



M x 16

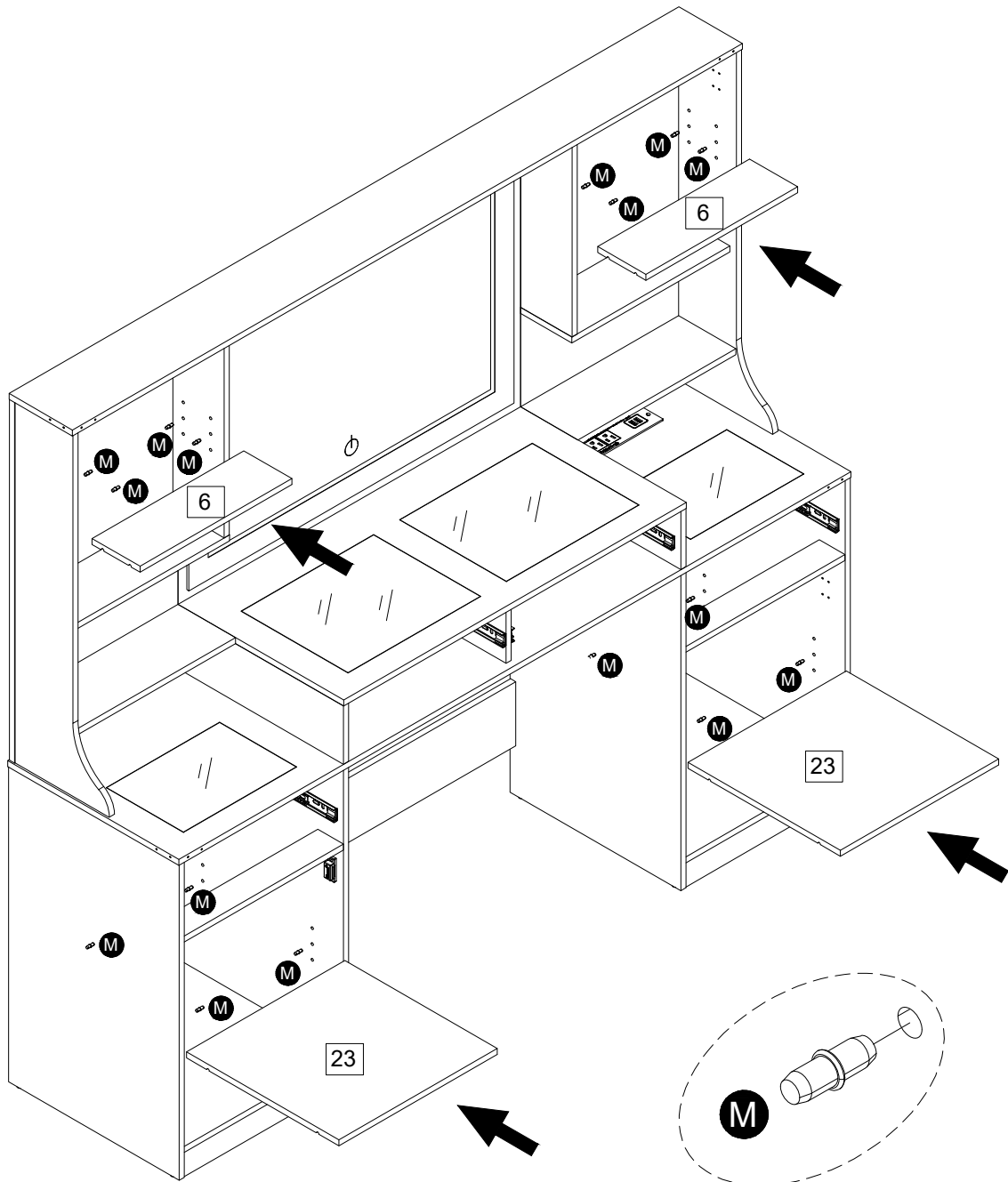

Assembly Instructions

Step 31

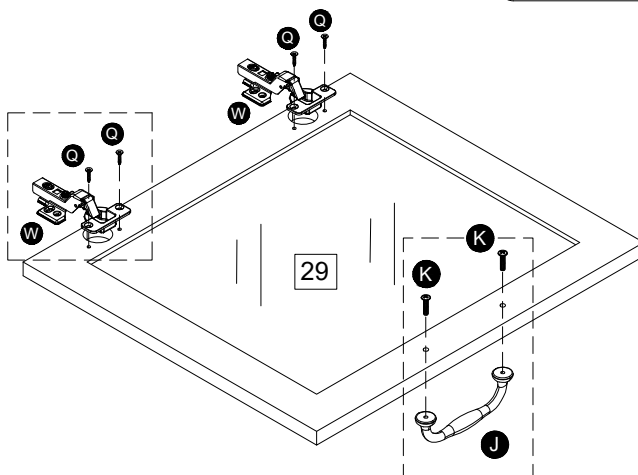
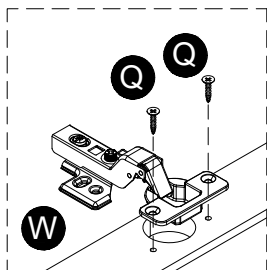

x 2

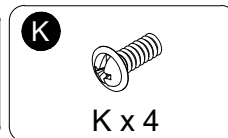
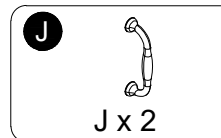
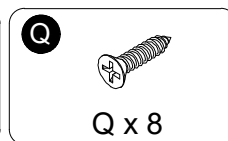
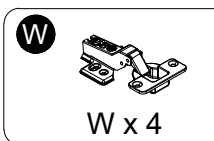
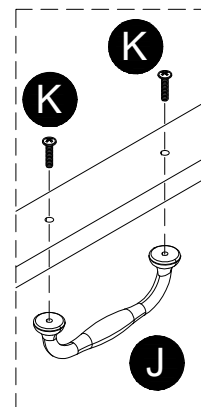

Step 32

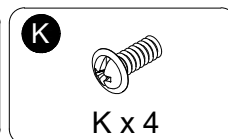
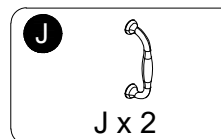
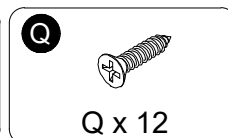
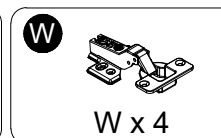
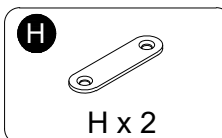
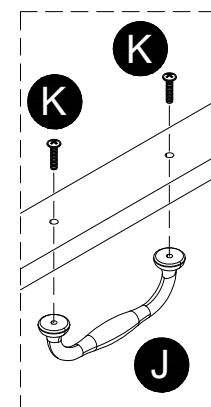
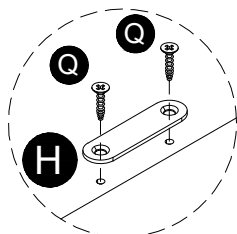
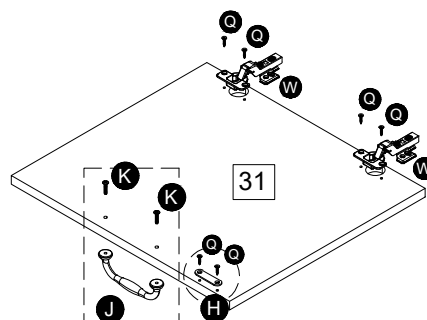
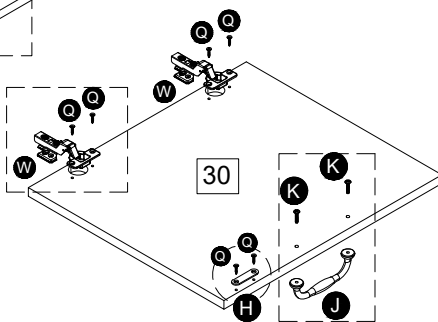
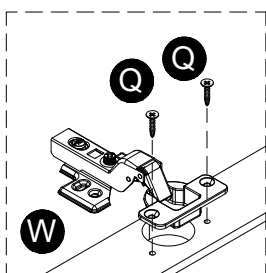

Assembly Instructions

Step 33

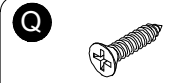

Q x 32

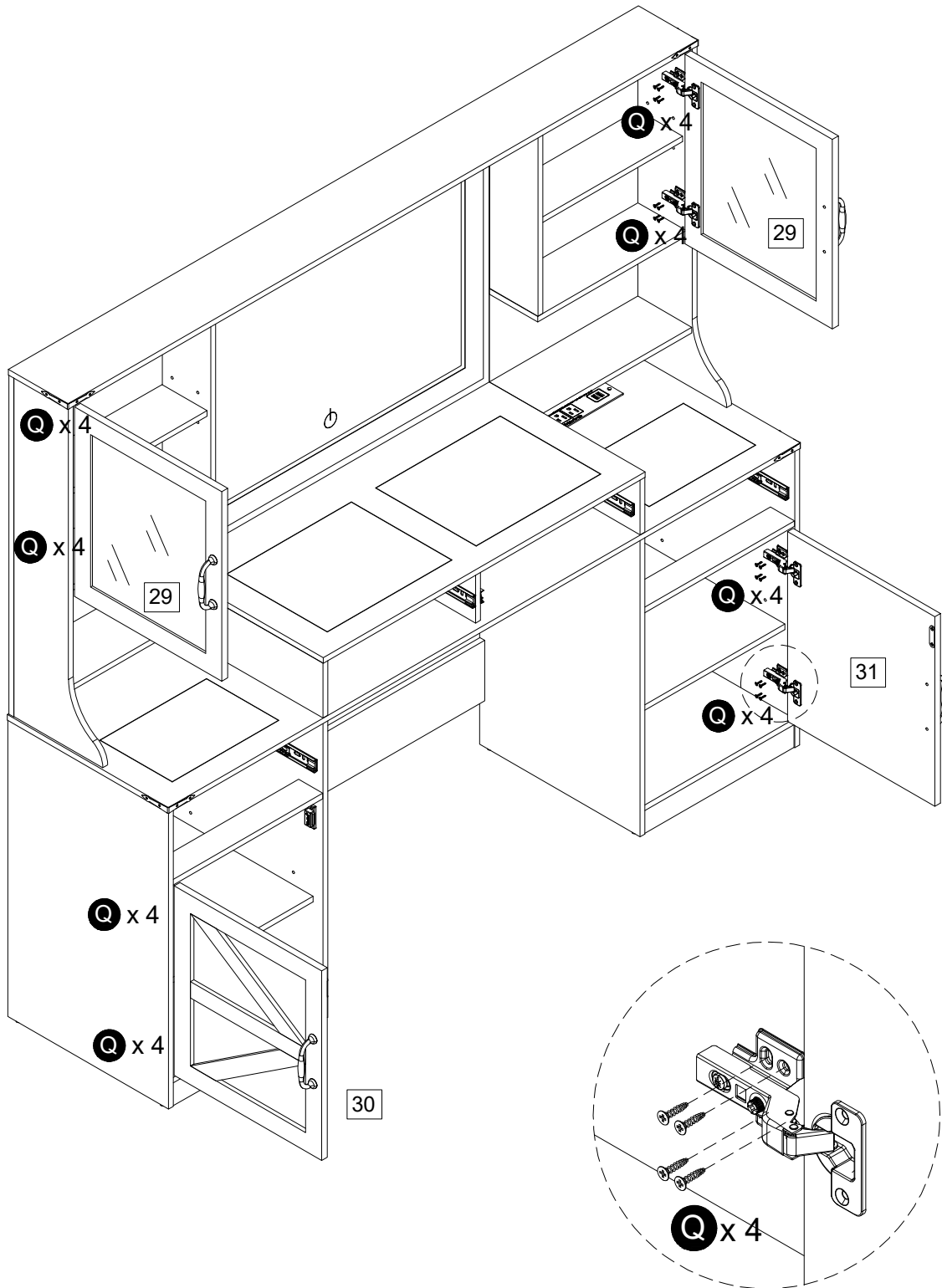

Assembly Instructions

Step 34

"Need to rotate and tighten B"

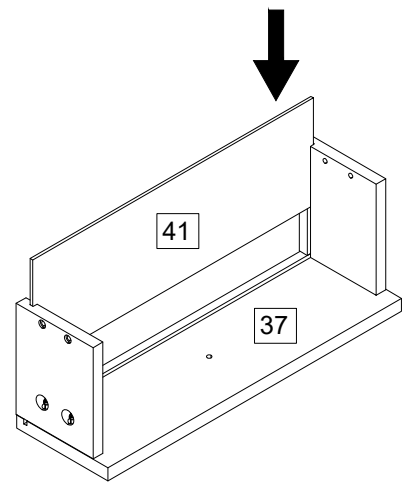
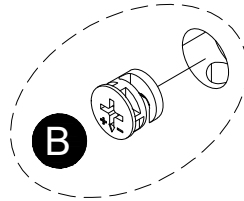
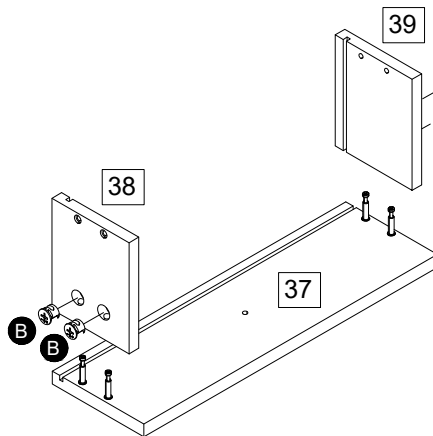
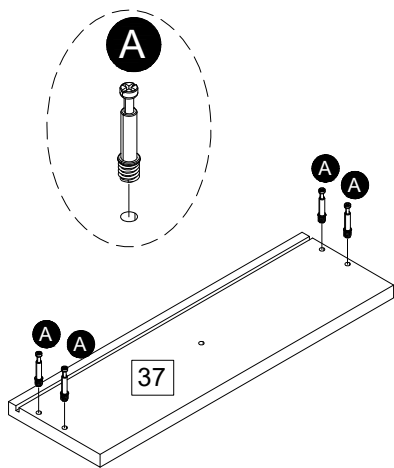
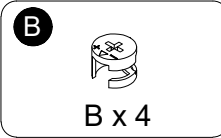
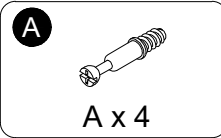
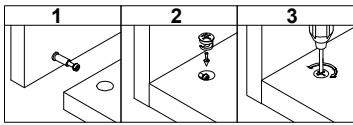

Step 35

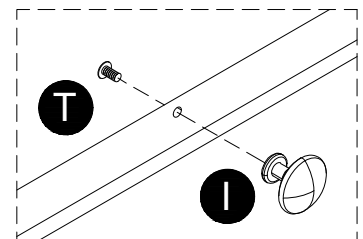
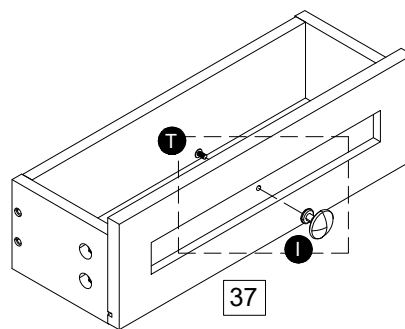
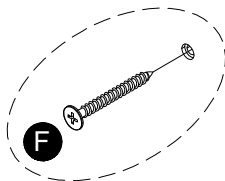
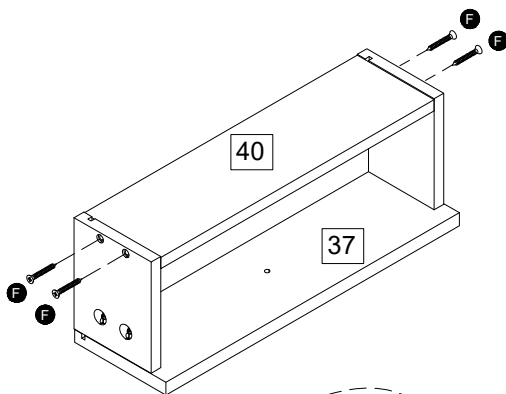
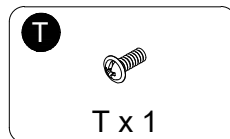
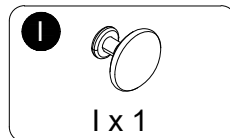
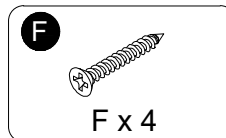

Assembly Instructions

Step 36

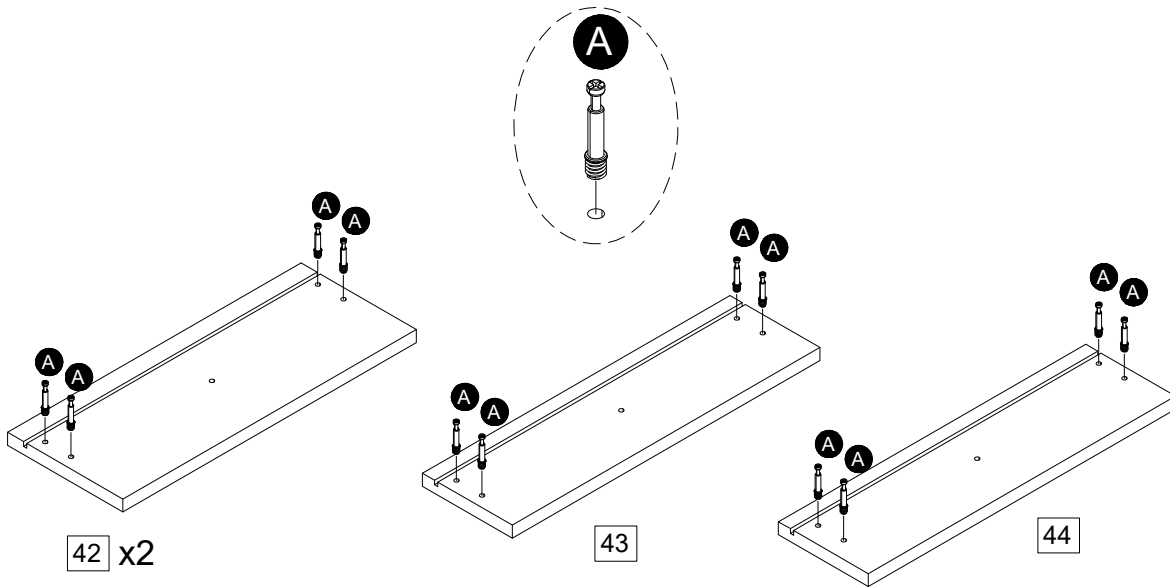
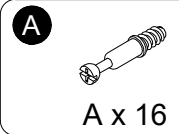

Step 37

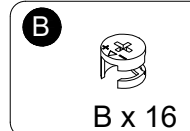

"Need to rotate and tighten B"

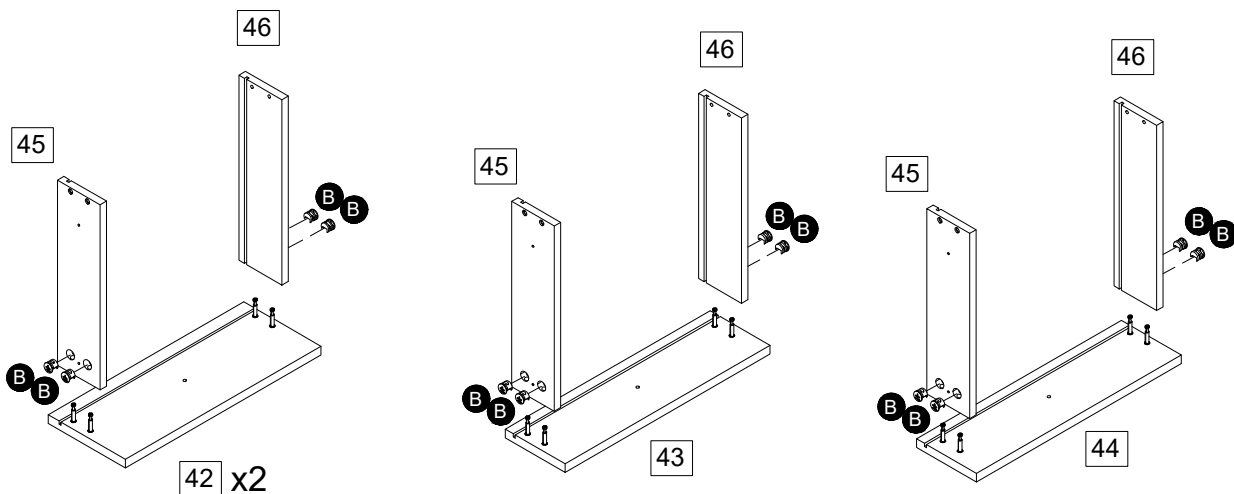
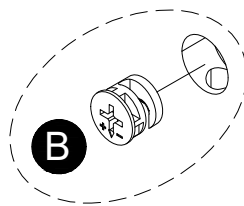
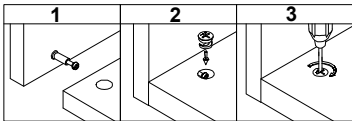

Assembly Instructions

Step 38

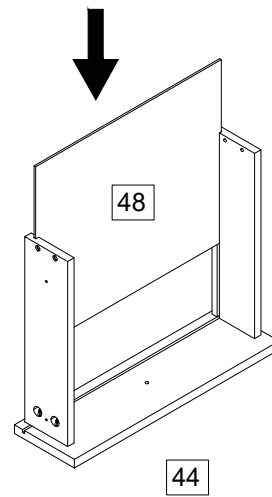
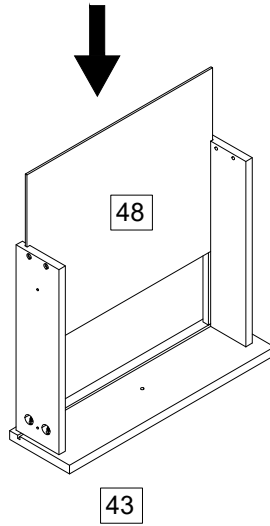
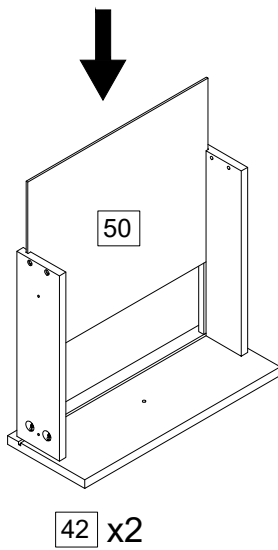

Step 39

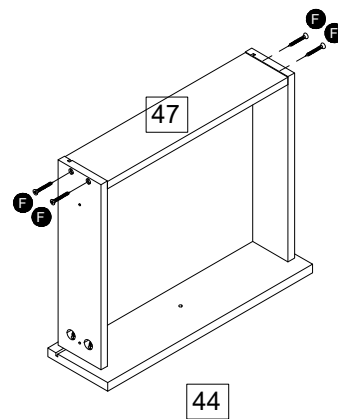
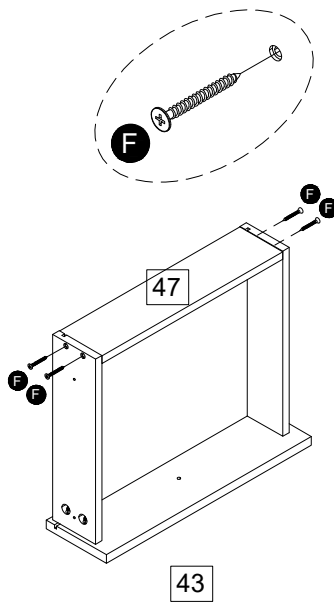
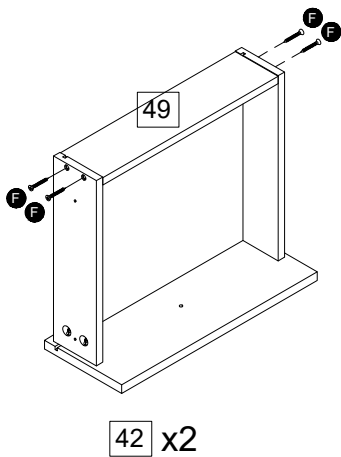
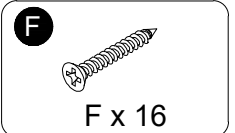

Assembly Instructions

Step 40

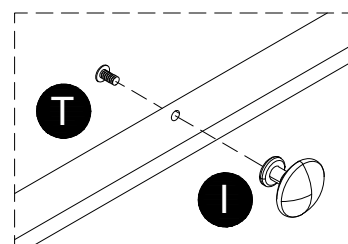
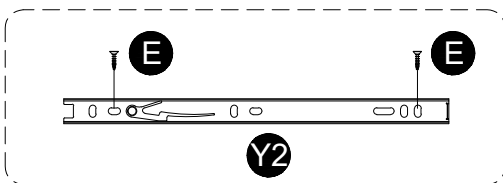
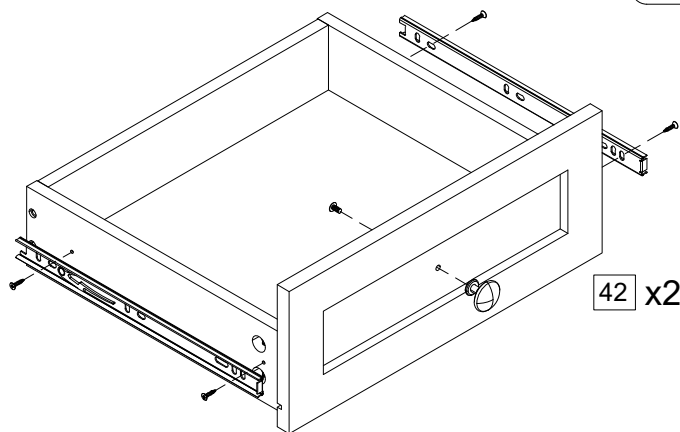
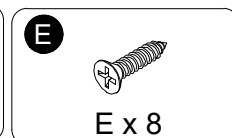
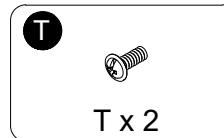
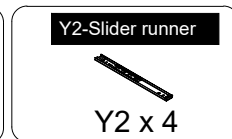
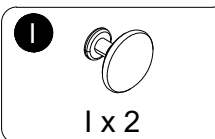

Step 41

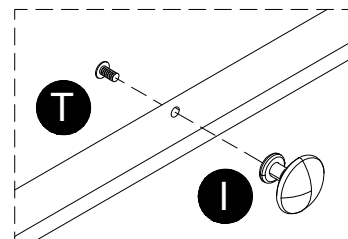
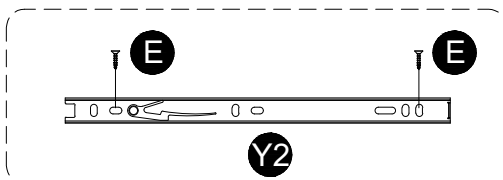
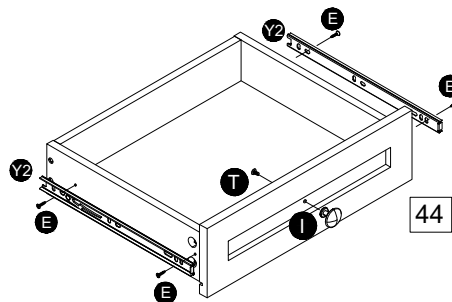
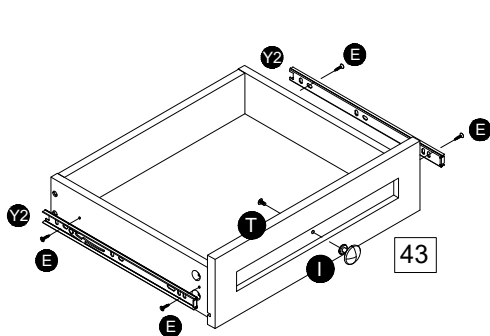
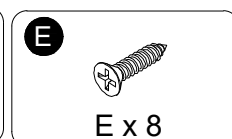
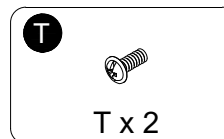
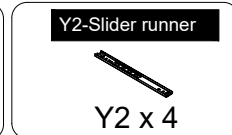
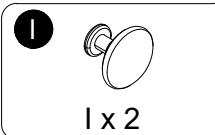

Assembly Instructions

Step 42

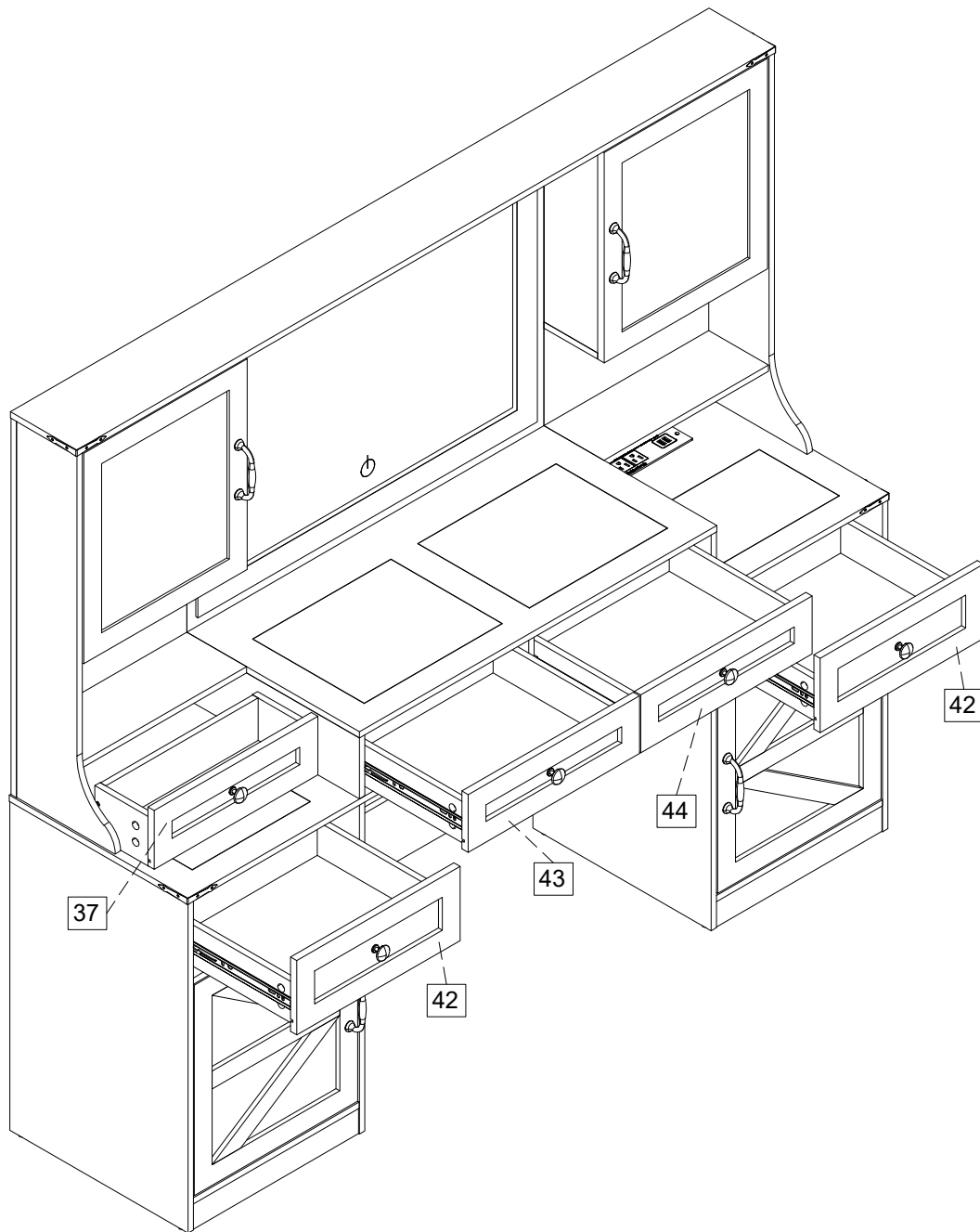

Assembly Instructions

Step 43

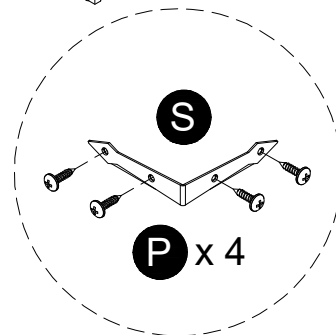
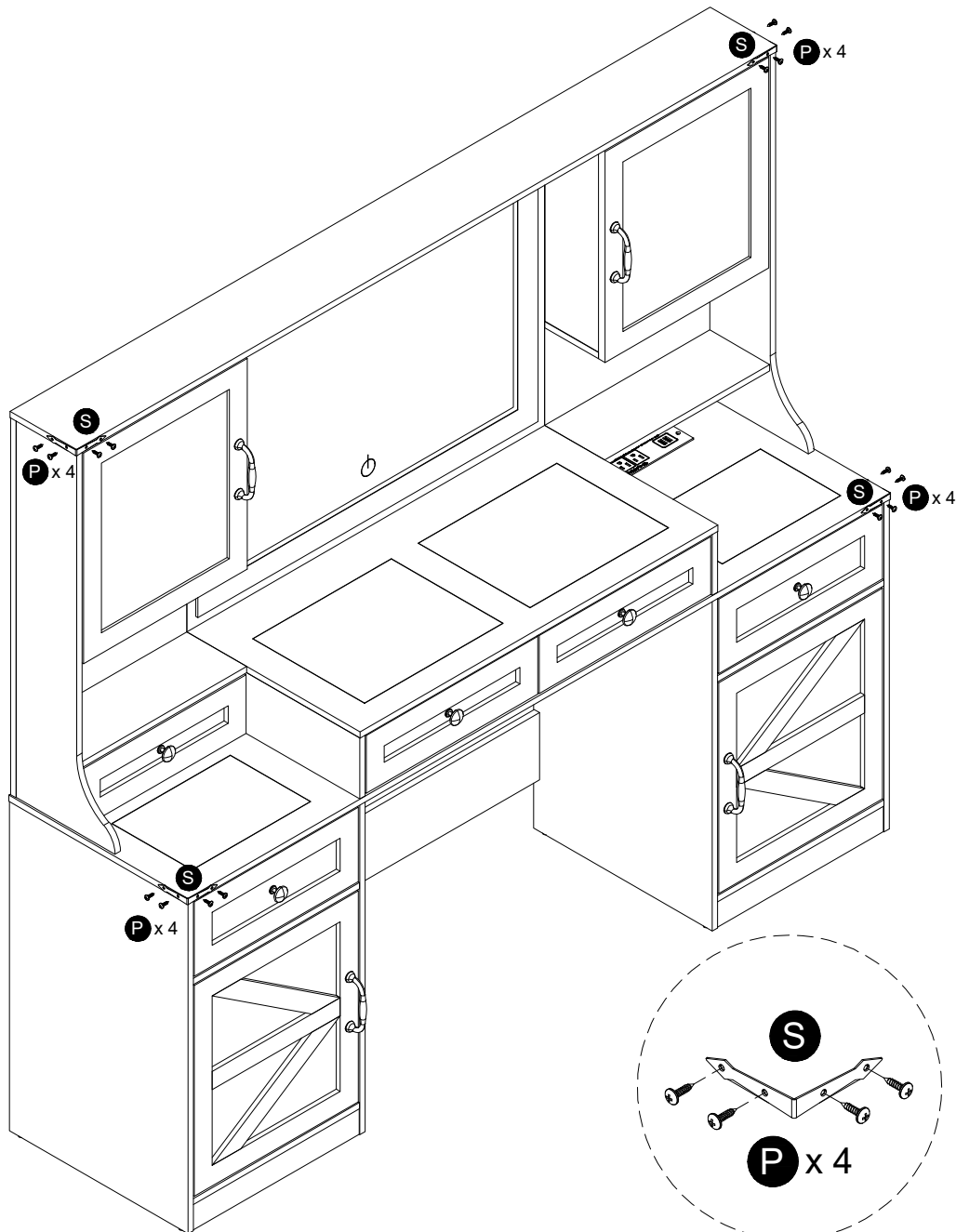
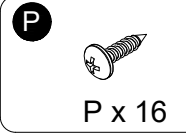
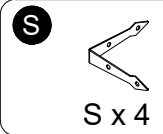

Assembly Instructions

Step 44

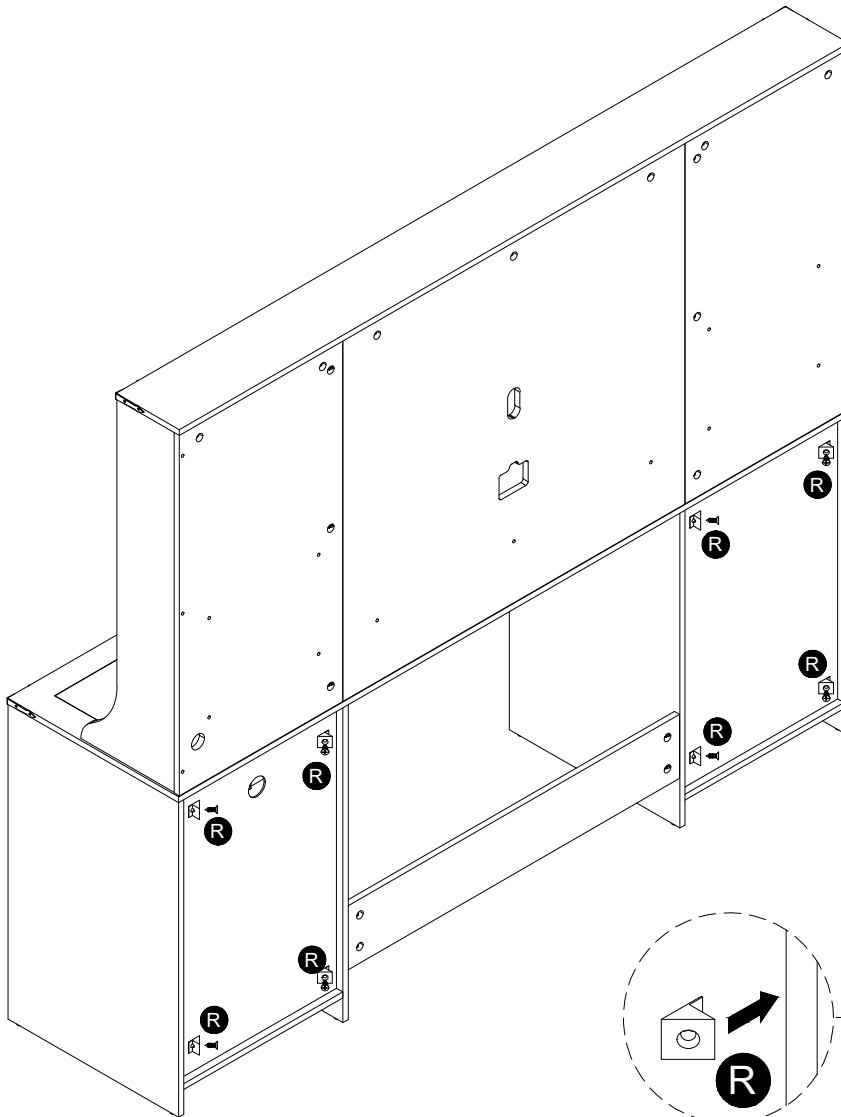
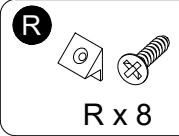

Assembly Instructions

Step 45

N



N x 1

O

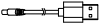

O x 1

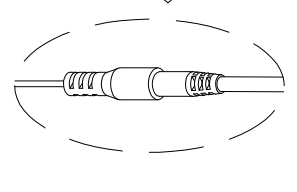
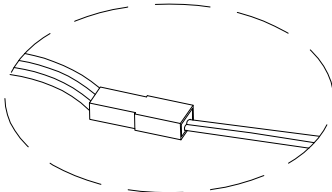
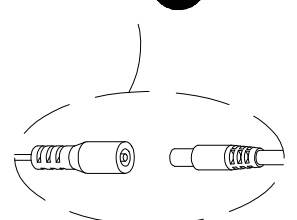
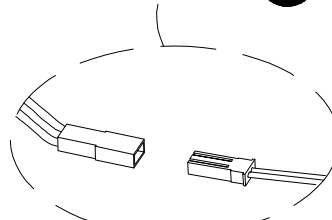
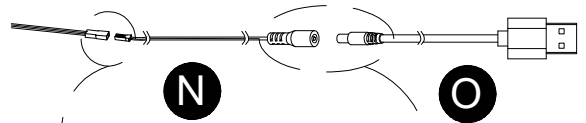
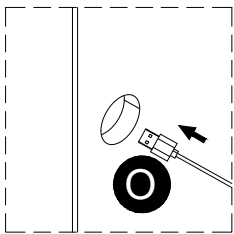
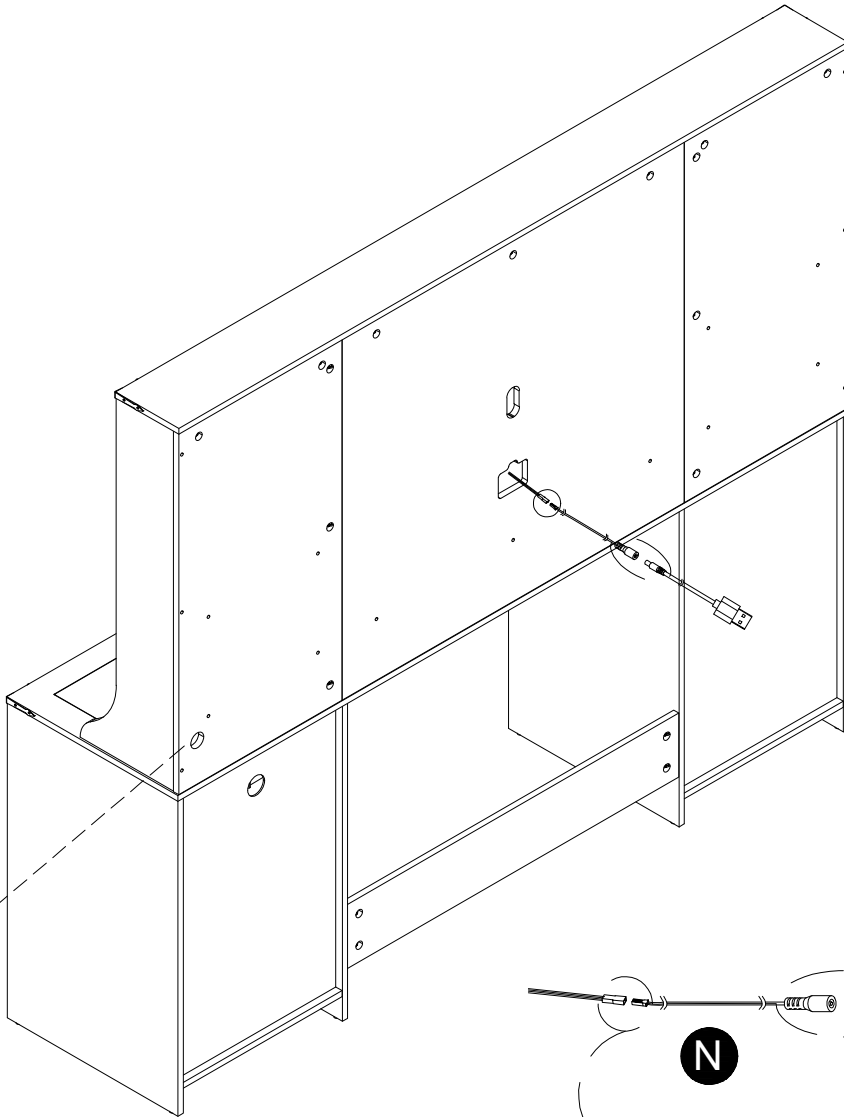

Assembly Instructions

Step 46

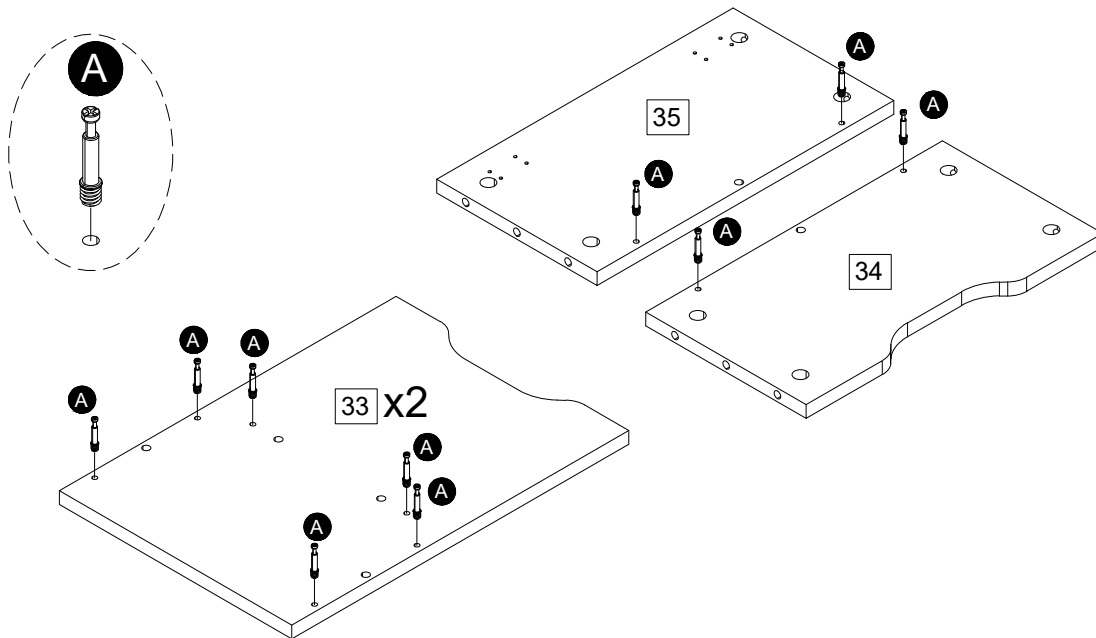
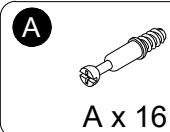

Step 47

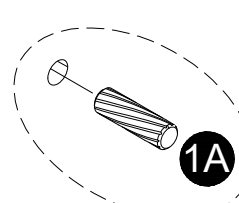
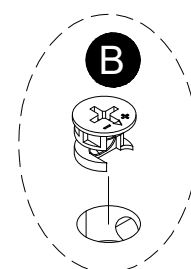
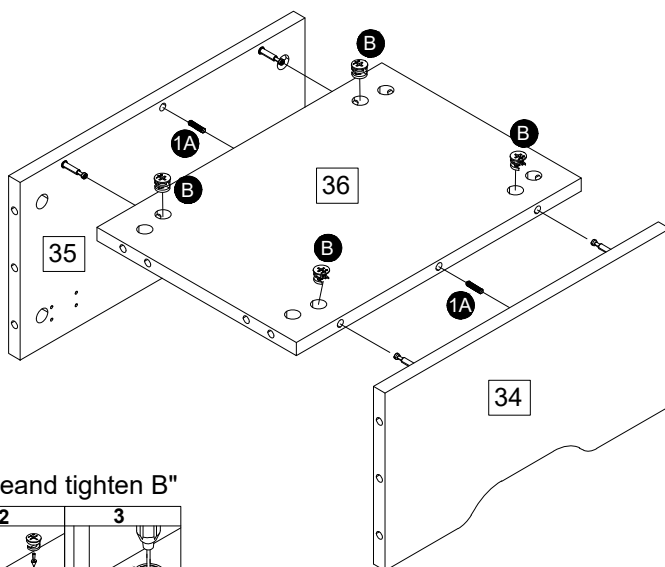
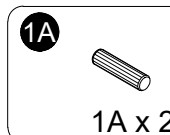
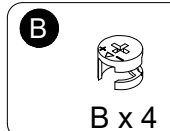

"Need to rotate and tighten B"

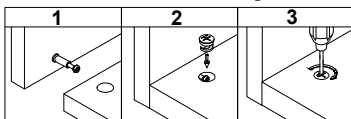

Assembly Instructions

Step 48

1A



1A x 8

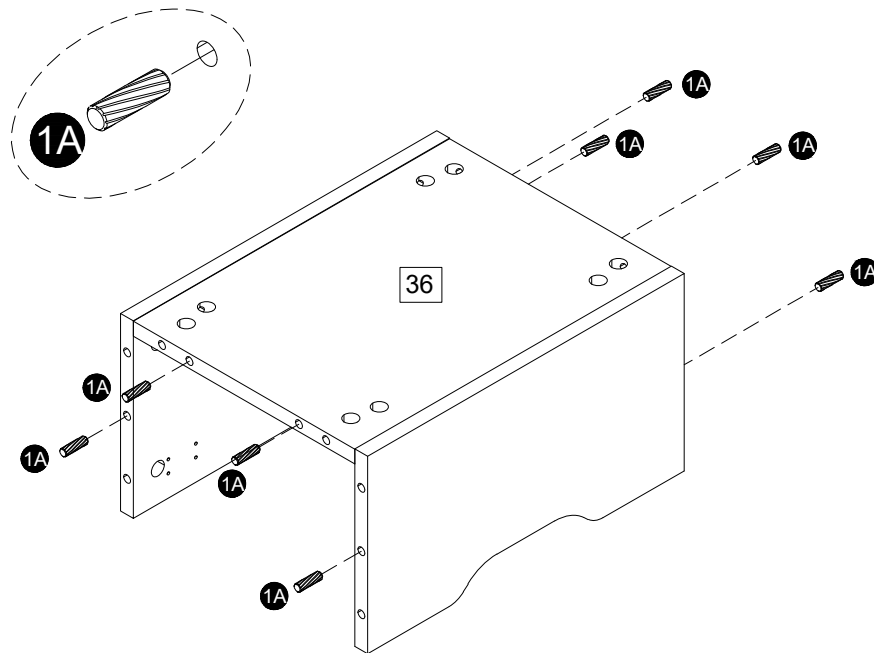

Step 49

B



B x 4

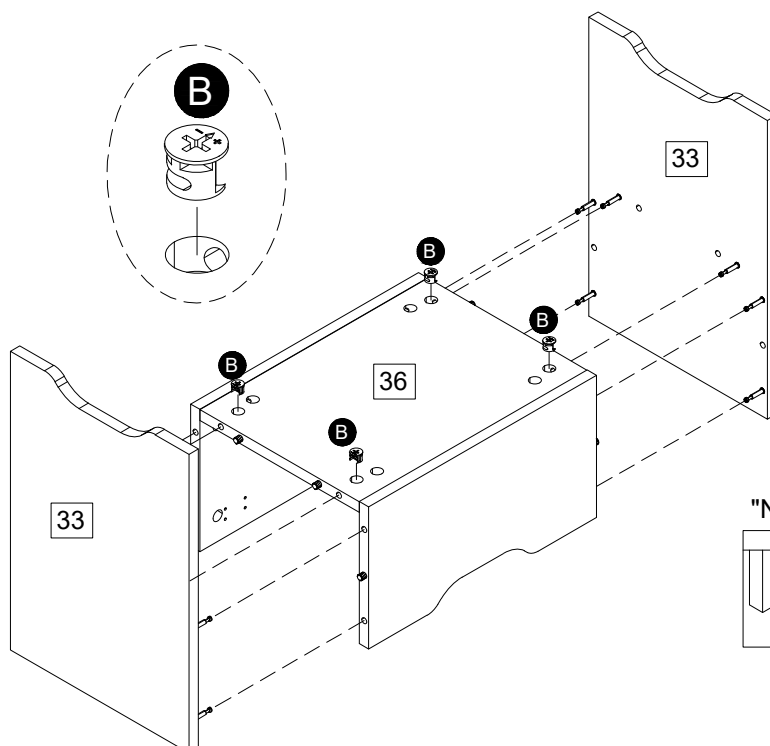

Assembly Instructions

Step 50

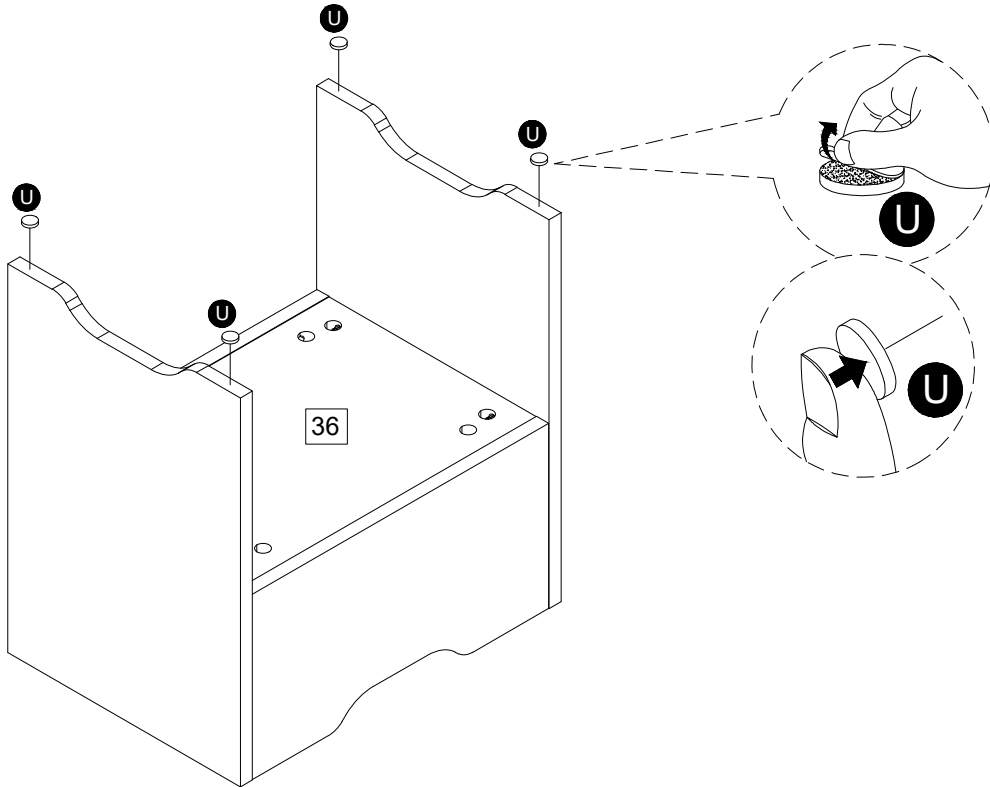
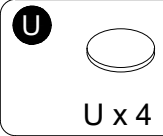

Step 51

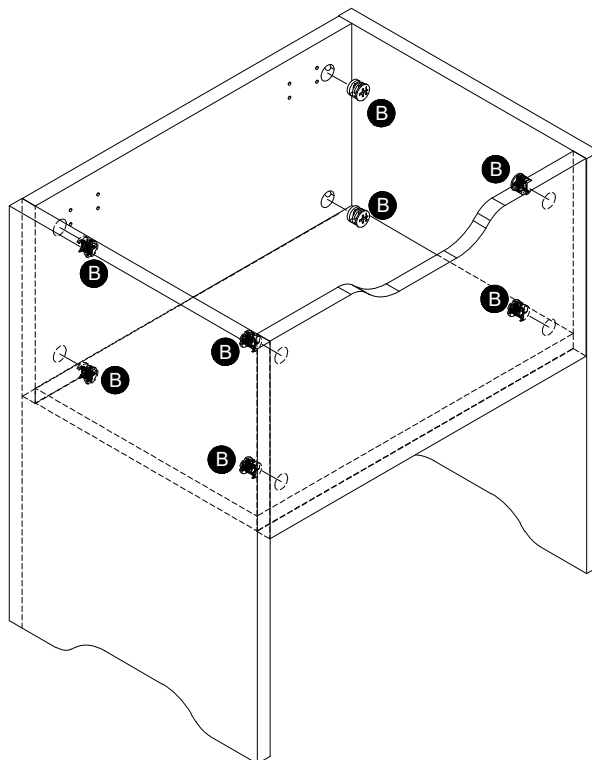
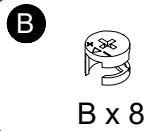

"Need to rotate and tighten B"

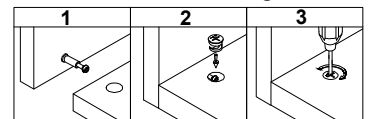

Assembly Instructions

Step 52

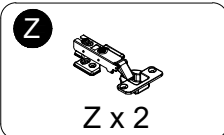
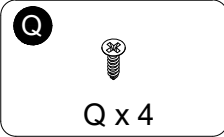
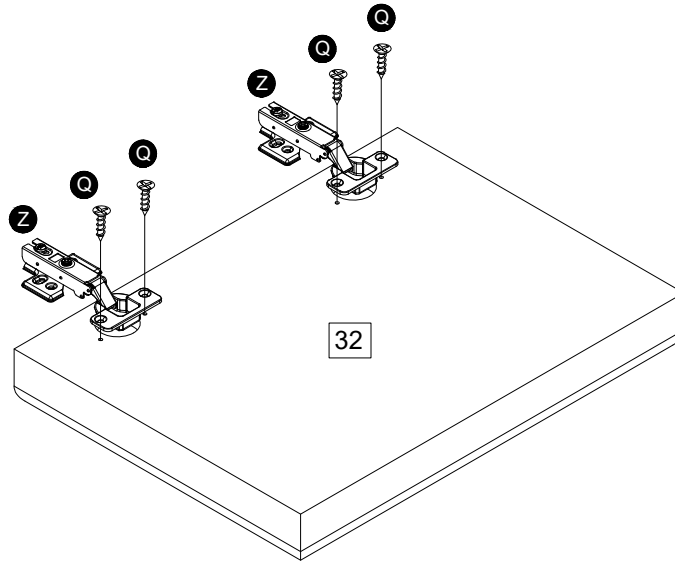
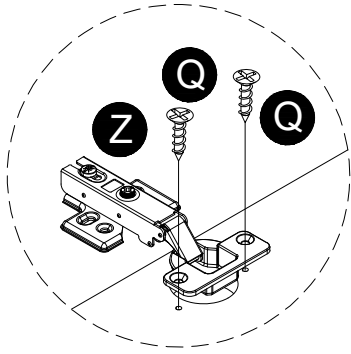

Step 53

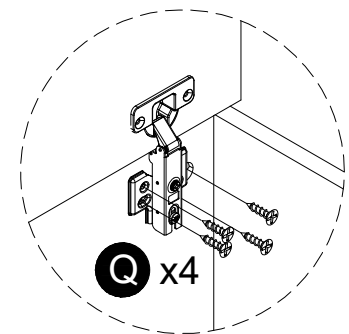
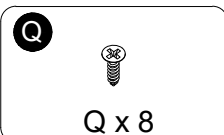
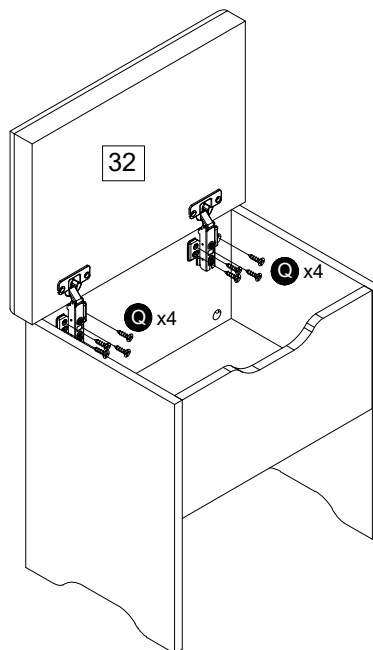
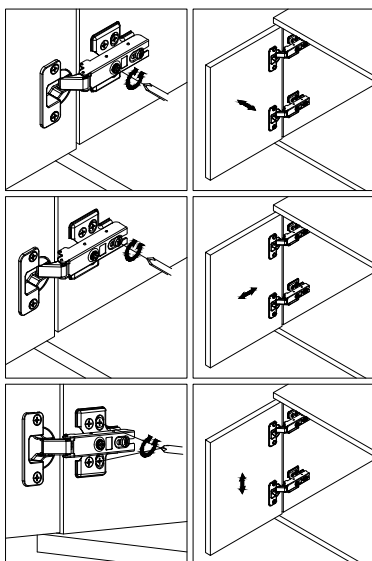

Assembly Instructions

Step 54

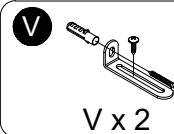

DANGER - To prevent furniture from toppling attach, mount, bolt or otherwise secure to walls and floors.
Do not put heavy items on top shelves.
Do not place unstable furniture near where children play.
An anchor kit suitable for plaster walls is included with this item, if you require a different kit consult your nearest hardware store.

