

ASSEMBLY INSTRUCTIONS

HYGG-001

HYGG-002

HYGG-003

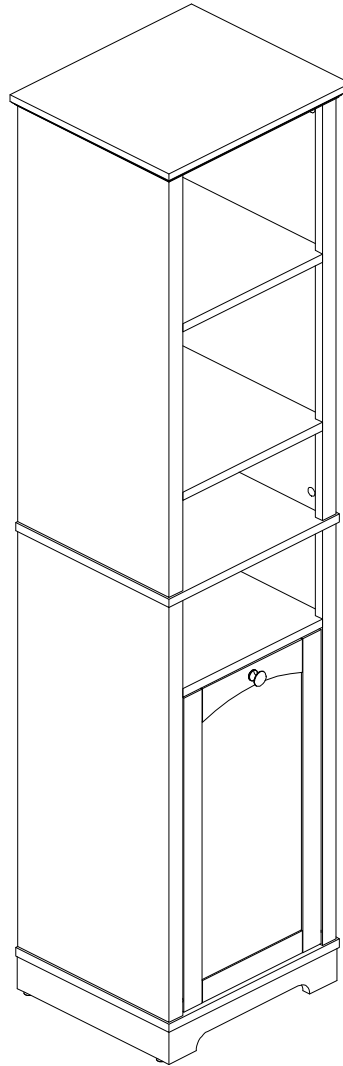

Notice:

1. Follow the installation instructions. Please confirm all accessories are preset before installation.
2. Do not fully tighten the screws during initial assembly. Fully tighten screws only once all pieces which are correctly assembled.
3. If you encounter any problems during installation, please contact our customer service.
4. Please unbox the item from the side with an open-label and put a carpet on the floor to avoid scratching it.

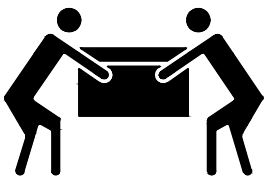

Recommended installers:2

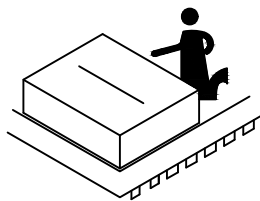

Put a carpet on the floor
before unpacking

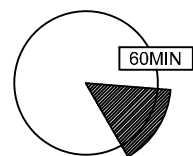

Estimate installation time:
60minutes





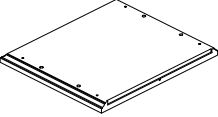
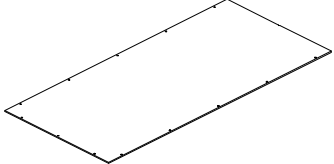
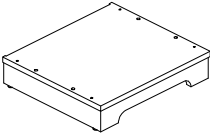
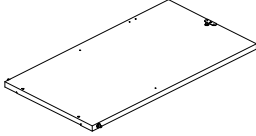
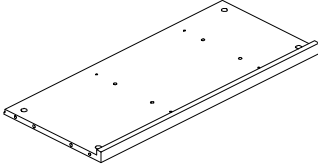
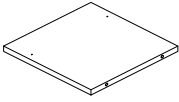
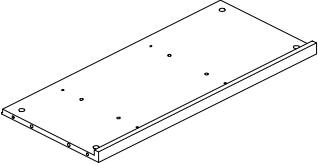
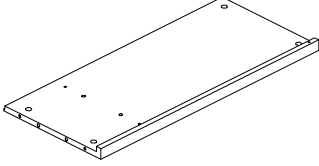
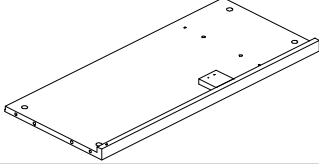
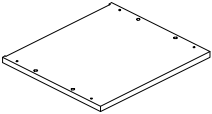
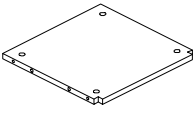
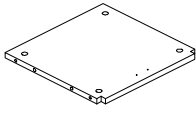

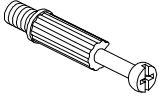
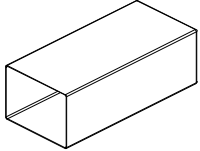
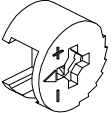

ASSEMBLY INSTRUCTIONS

PART LIST

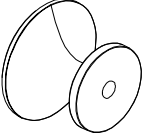
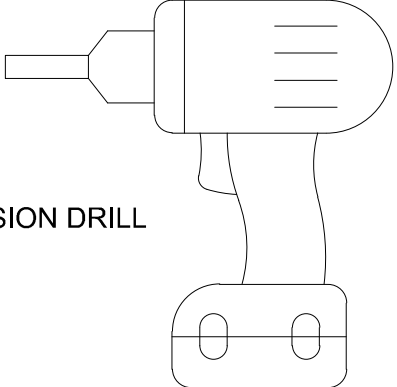
Item no.	Reference Image	Qty	Item no.	Reference Image	Qty
(A)		X1	(J)		X2
(B)		X1	(K)		X1
(C)		X1	(L)		X1
(D)		X1			
(E)		X1			
(F)		X1			
(G)		X1			
(H)		X2			
(I)		X1			

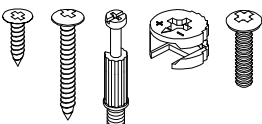
ASSEMBLY INSTRUCTIONS

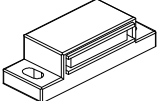
HARDWARE LIST

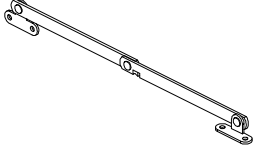
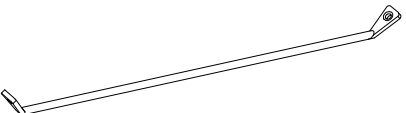
Item no.	Reference Image	Qty	Item	Reference Image	Qty
1		X30+3	11		X1
2		X30+3	12		X1
3		X1	<p>The following tools are needed. But not included.</p>  <p>PERCUSSION DRILL</p>  <p>SCREW DRIVER</p> 		
4	 Ø5/32"x3/4"	X1			
5	 Ø8x30mm	X28+2			
6		X1			
7	 Ø6xØ3x14 mm	X8			
8	 Ø6.5xØ3x15 mm	X29+2			
9		X1			
10		X2			

ASSEMBLY INSTRUCTIONS

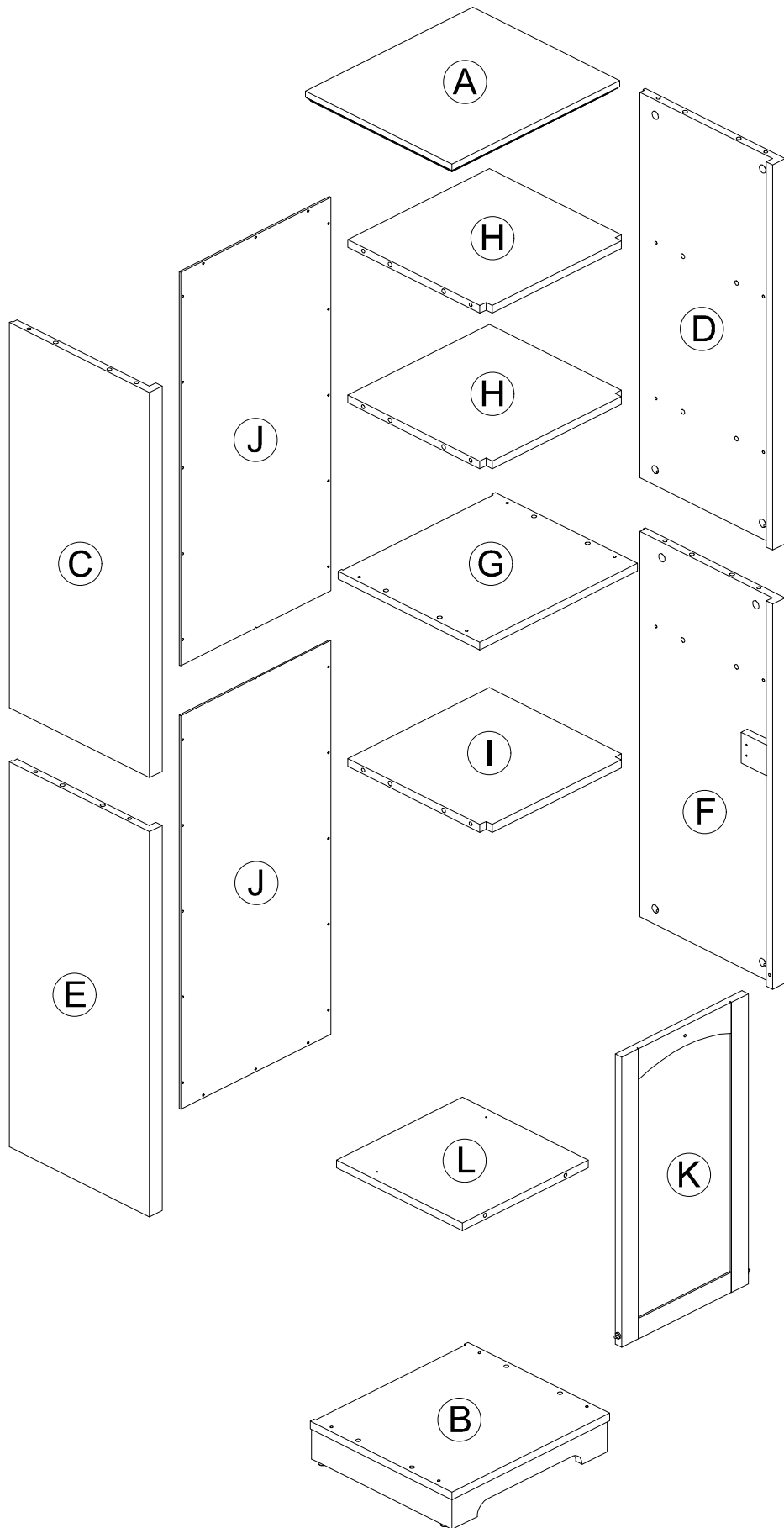

ASSEMBLY INSTRUCTIONS

1

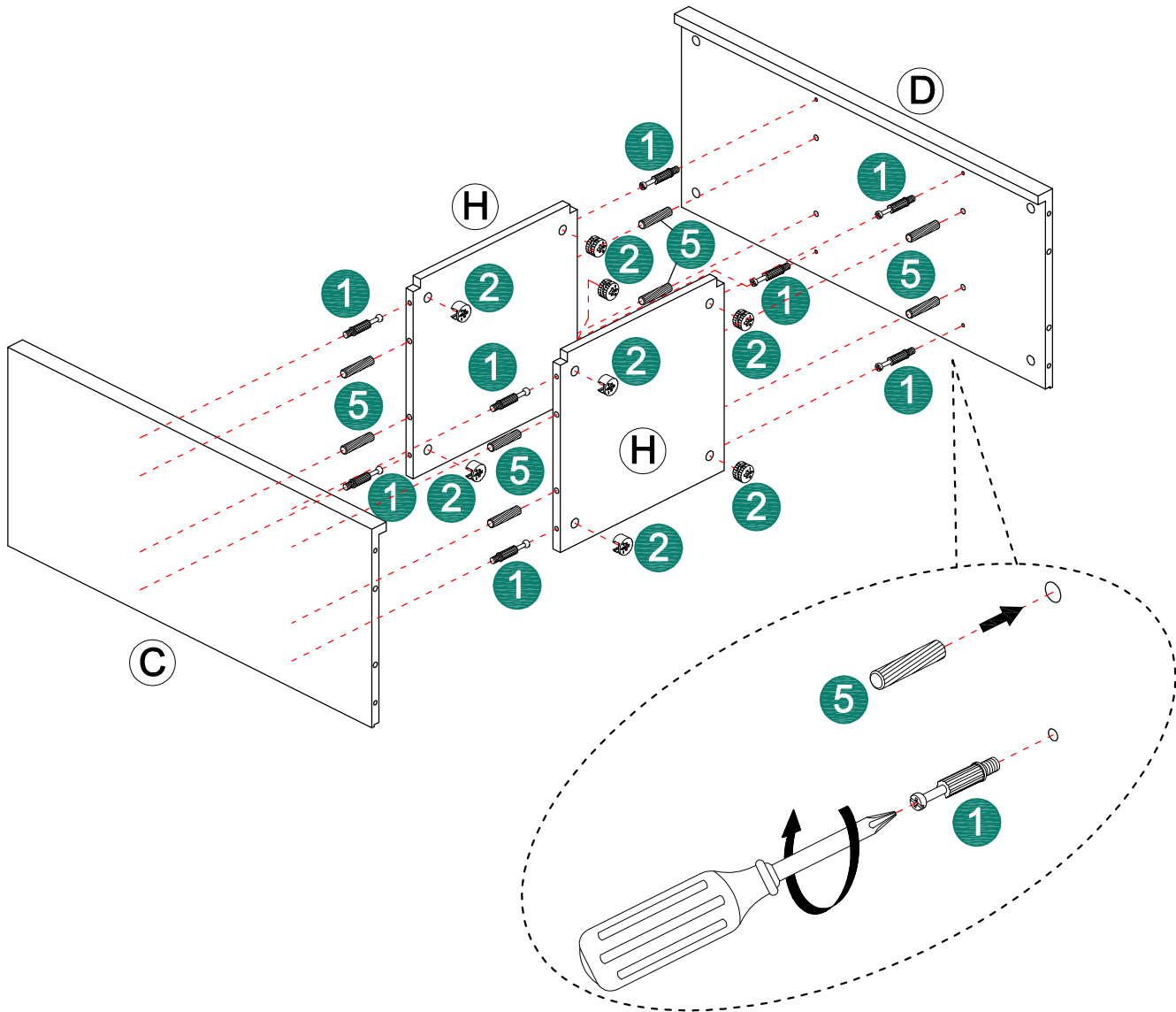
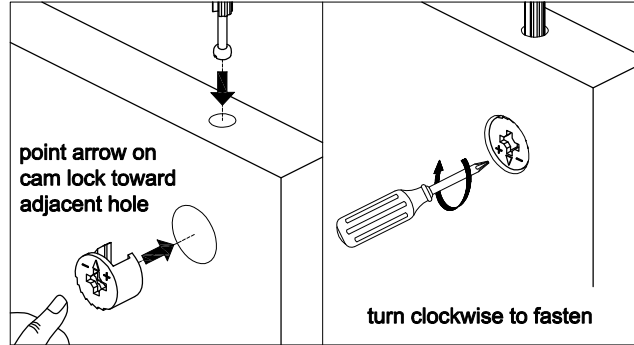
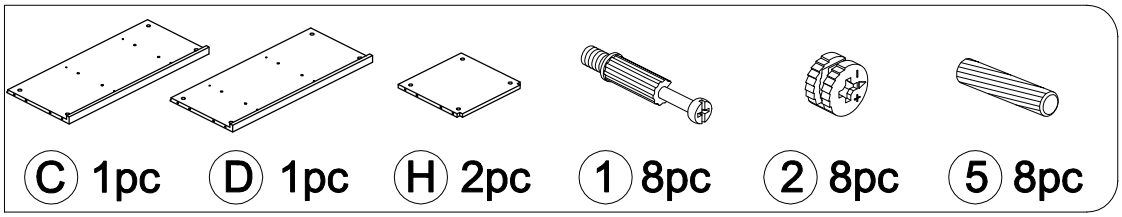

ASSEMBLY INSTRUCTIONS

2

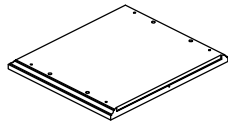

A 1pc

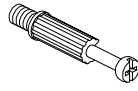

1 4pc



2 4pc

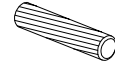

5 4pc

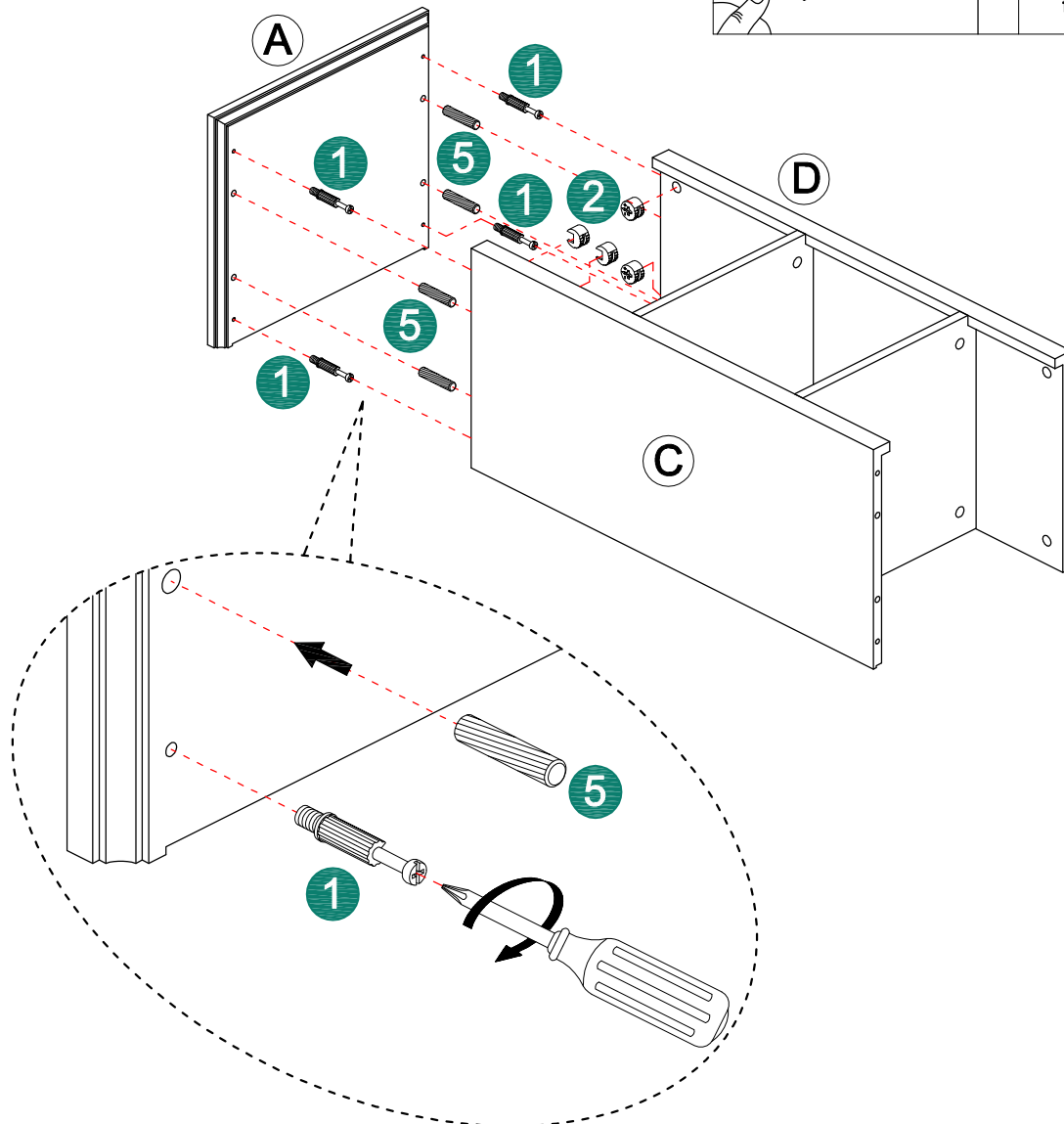
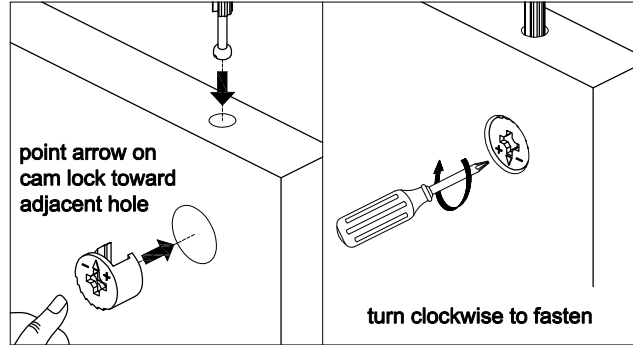

ASSEMBLY INSTRUCTIONS

3

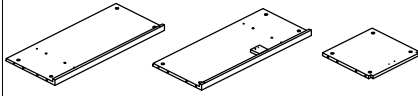

ⓔ 1pc

ⓕ 1pc

ⓖ 1pc

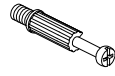

① 4pc



② 4pc



⑤ 4pc

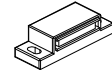

⑥ 1pc



⑧ 2pc

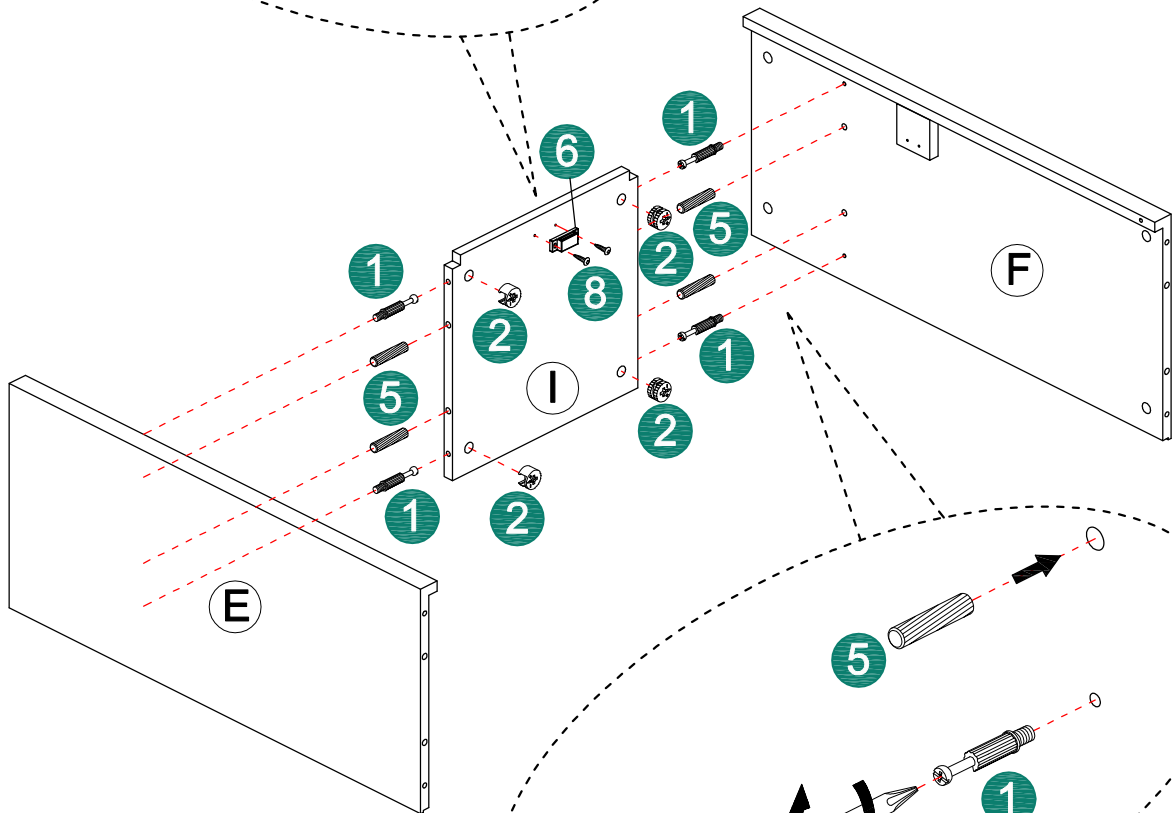
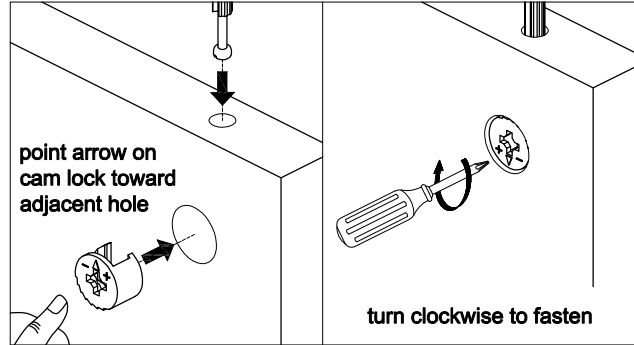
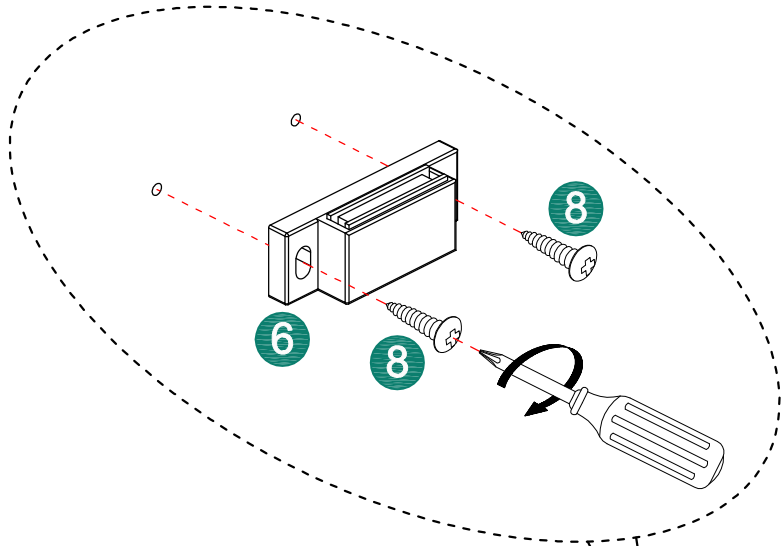

ASSEMBLY INSTRUCTIONS

4

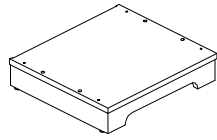

(B) 1pc

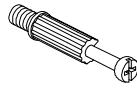

(1) 4pc



(2) 4pc

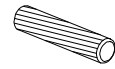

(5) 4pc

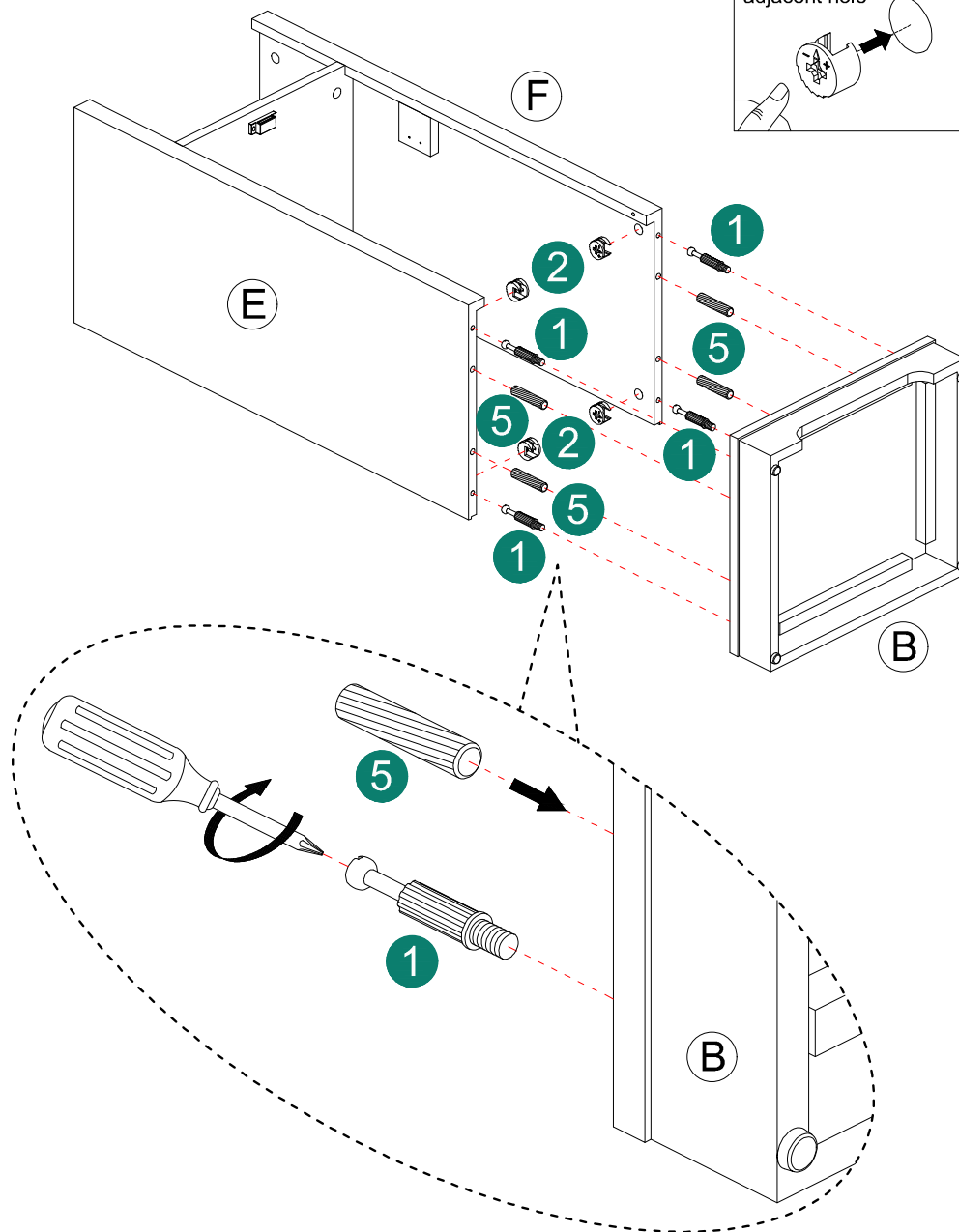
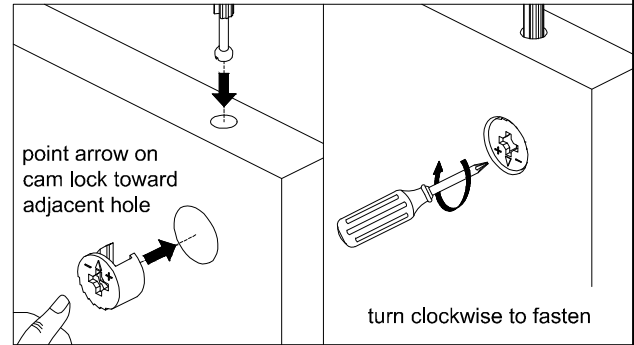

ASSEMBLY INSTRUCTIONS

5

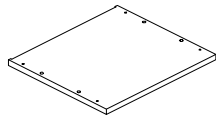

G 1pc

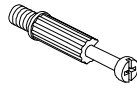

1 4pc



2 4pc

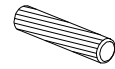

5 4pc

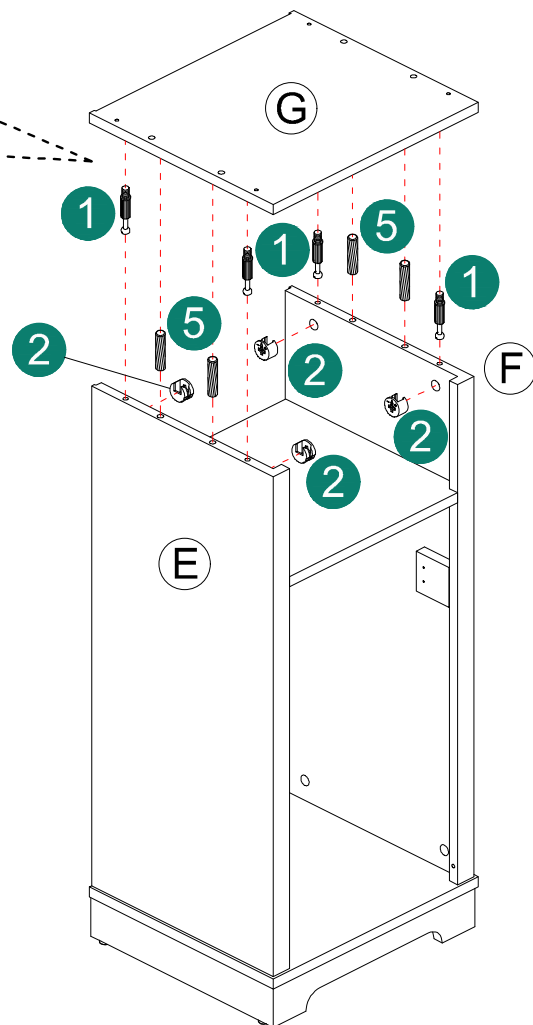
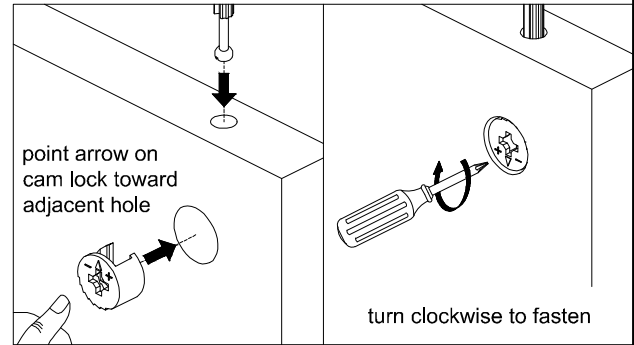
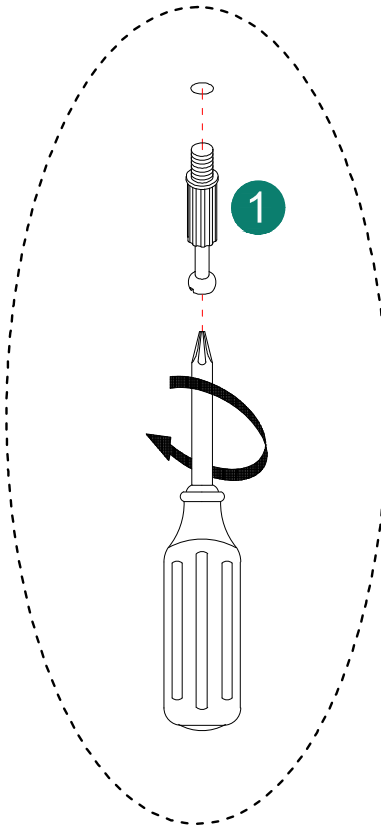

ASSEMBLY INSTRUCTIONS

6

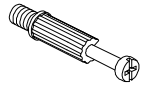

1 4pc



2 4pc

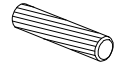

5 4pc

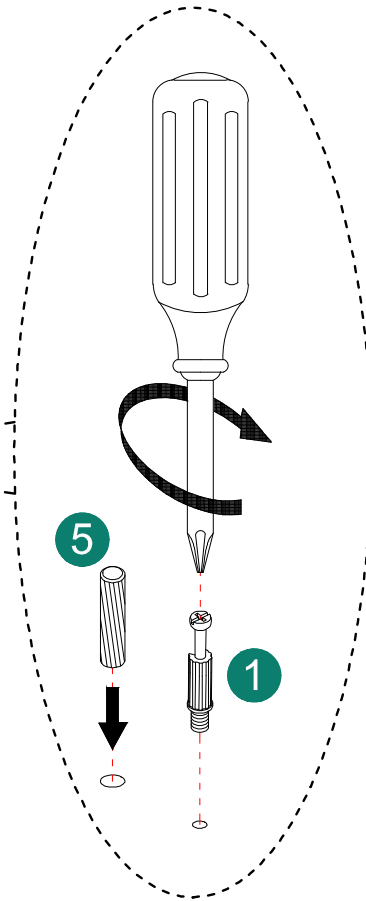
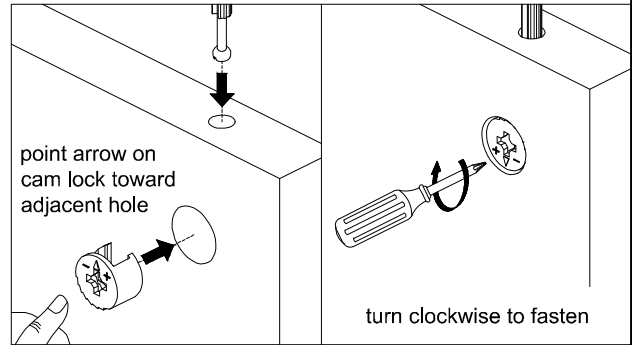
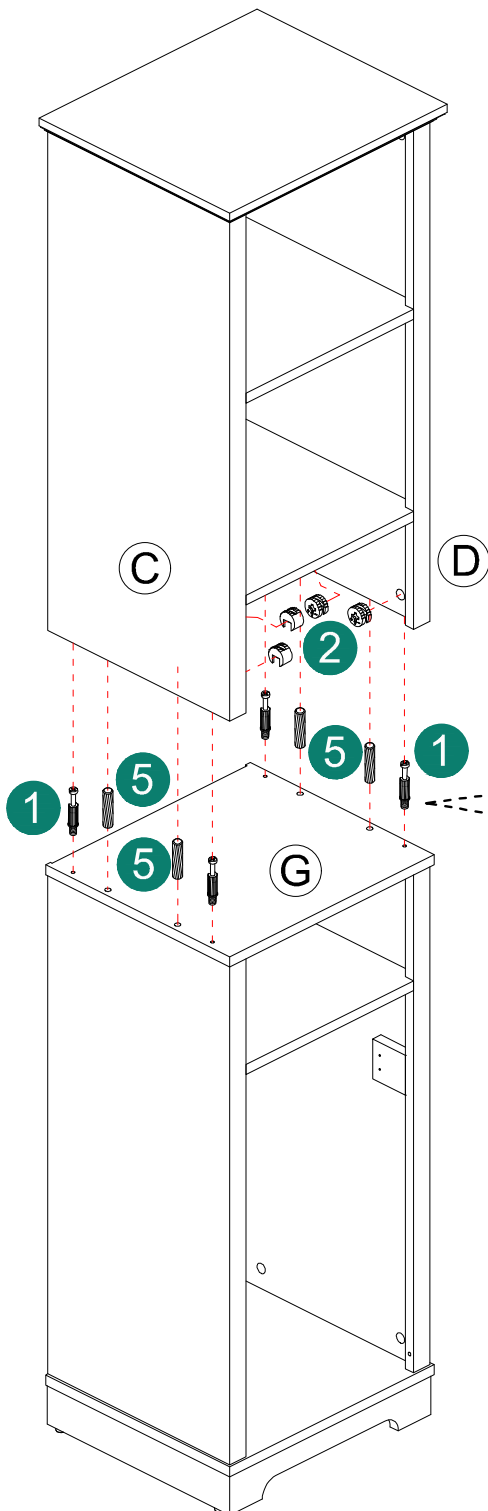

ASSEMBLY INSTRUCTIONS

7

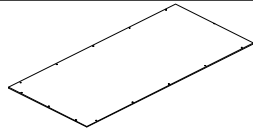

J 2pc



8 27pc

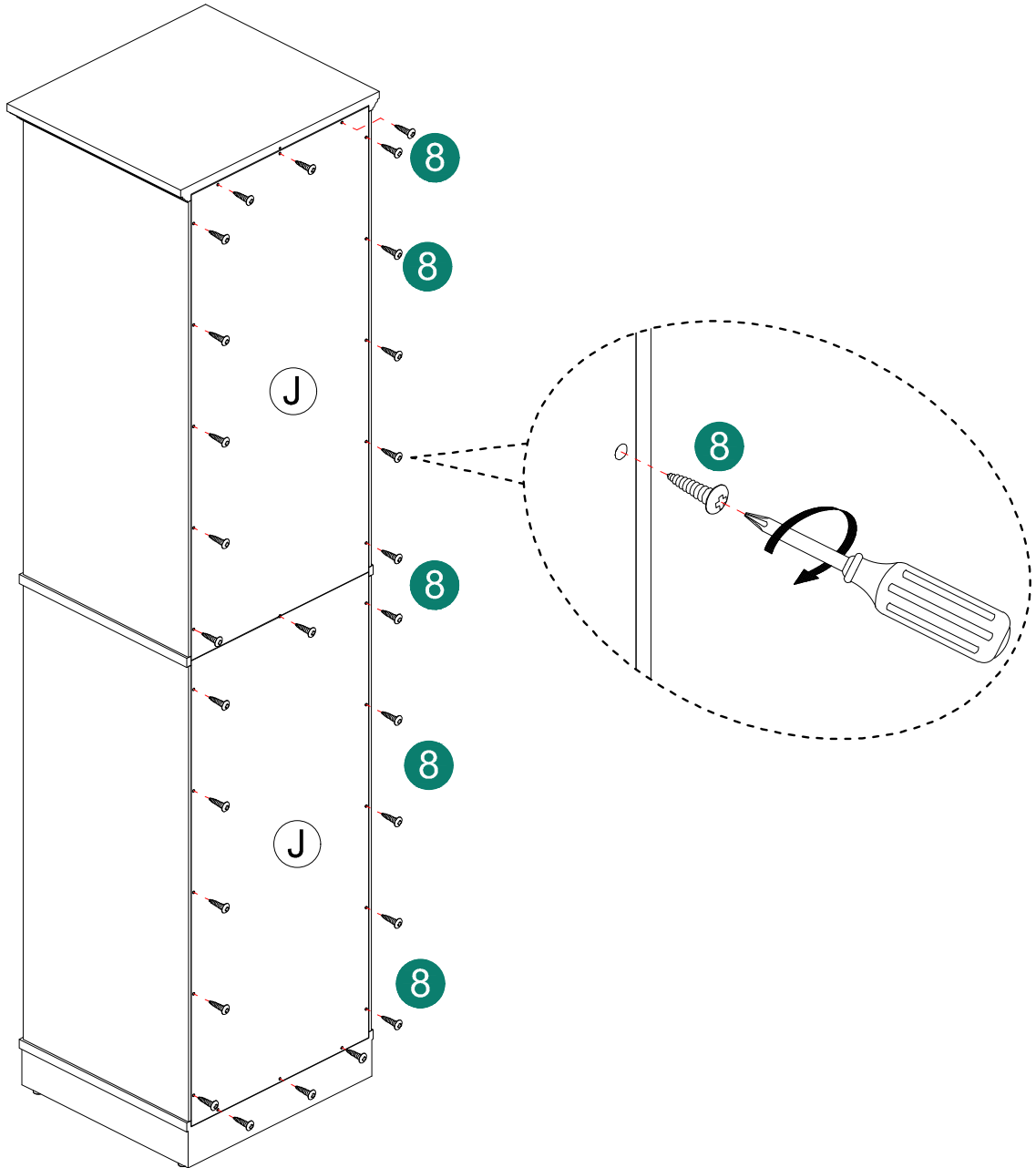

ASSEMBLY INSTRUCTIONS

8

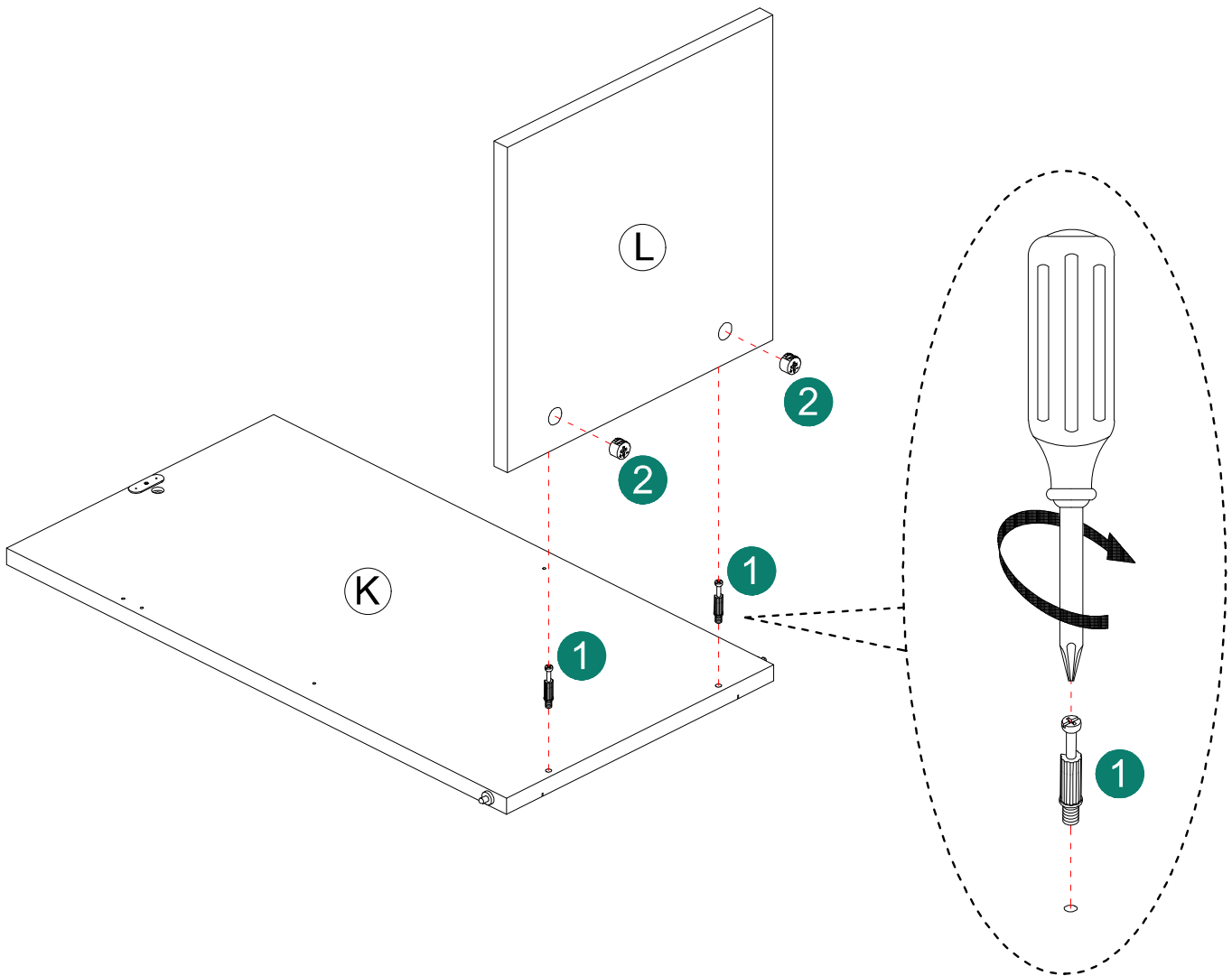
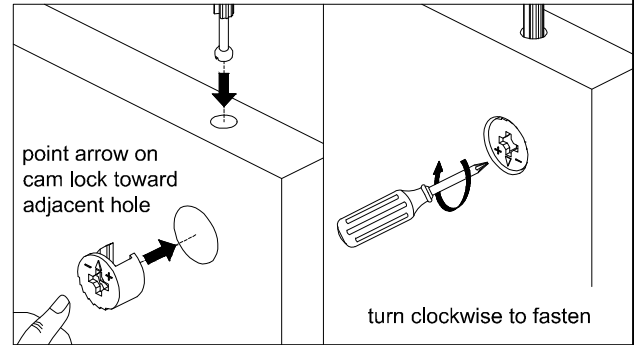
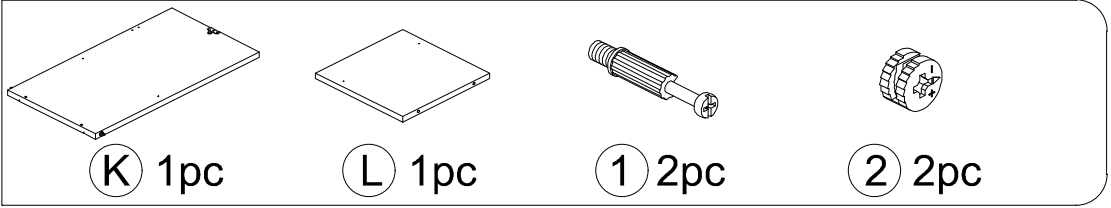

ASSEMBLY INSTRUCTIONS

9

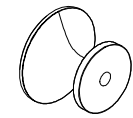

3 1pc



4 1pc



7 4pc

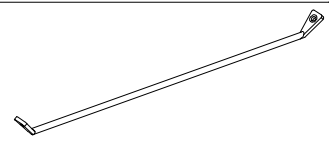

10 2pc

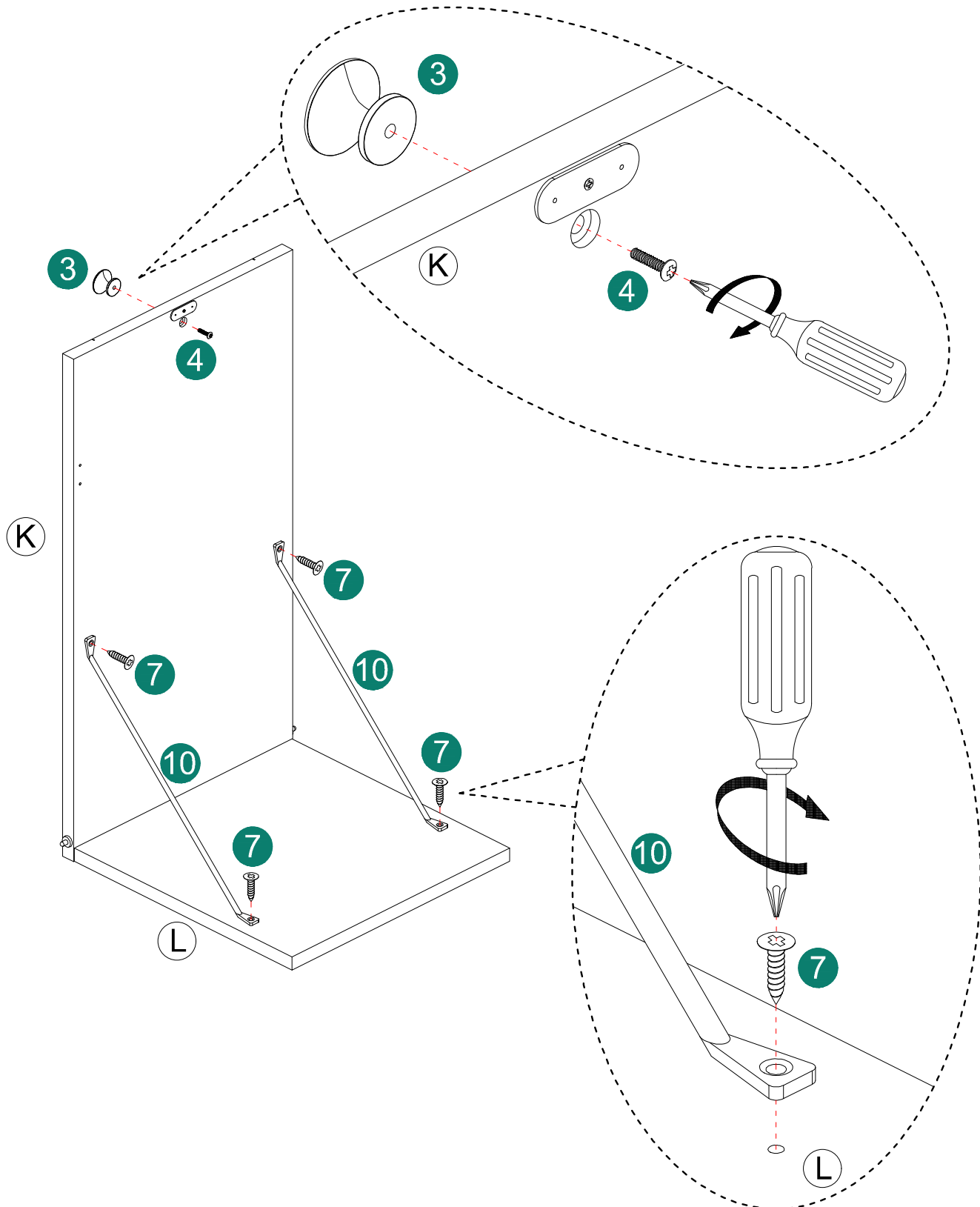

ASSEMBLY INSTRUCTIONS

10

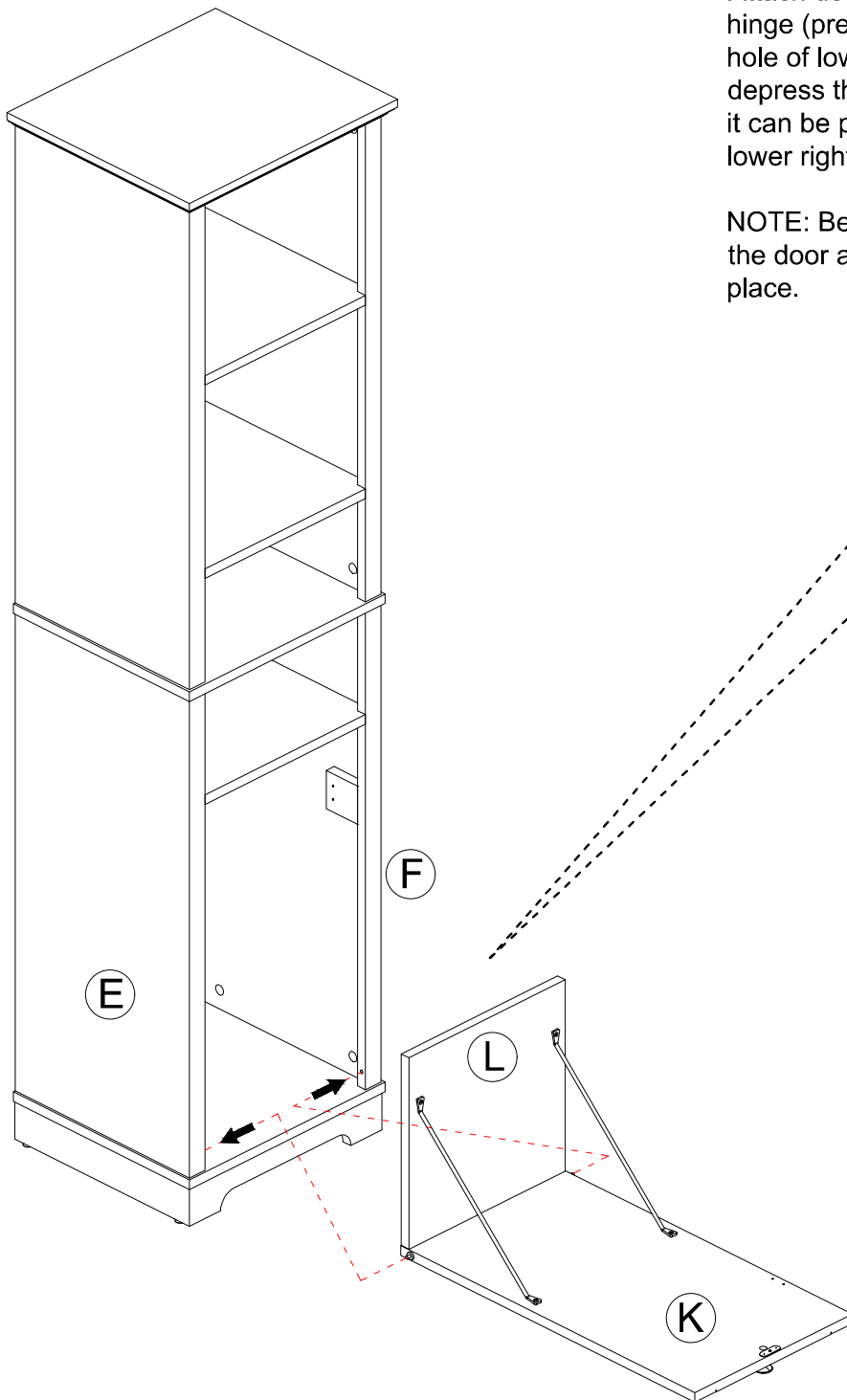

Attach door panels (part K) by placing left pin hinge (pre-installed in door) in the pre-drilled hole of lower left side panel (part E). Then depress the right spring-loaded pin hinge so it can be placed in the pre-drilled hole of lower right side panel (part F).

NOTE: Be sure top and bottom pin hinges of the door are fully extended to secure door in place.

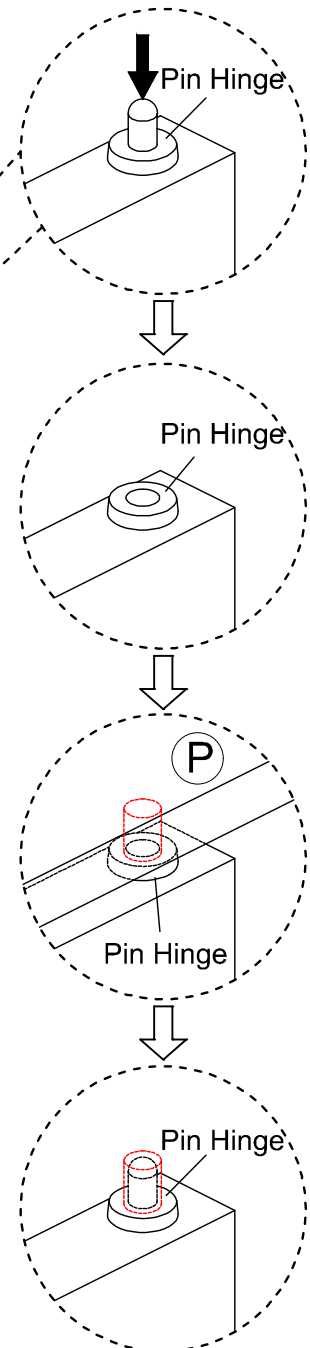

ASSEMBLY INSTRUCTIONS

11

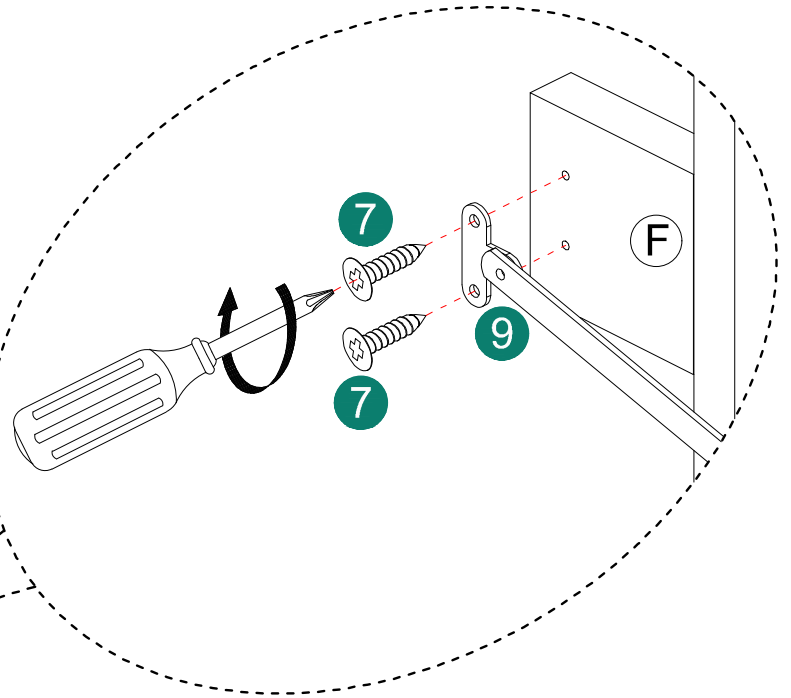
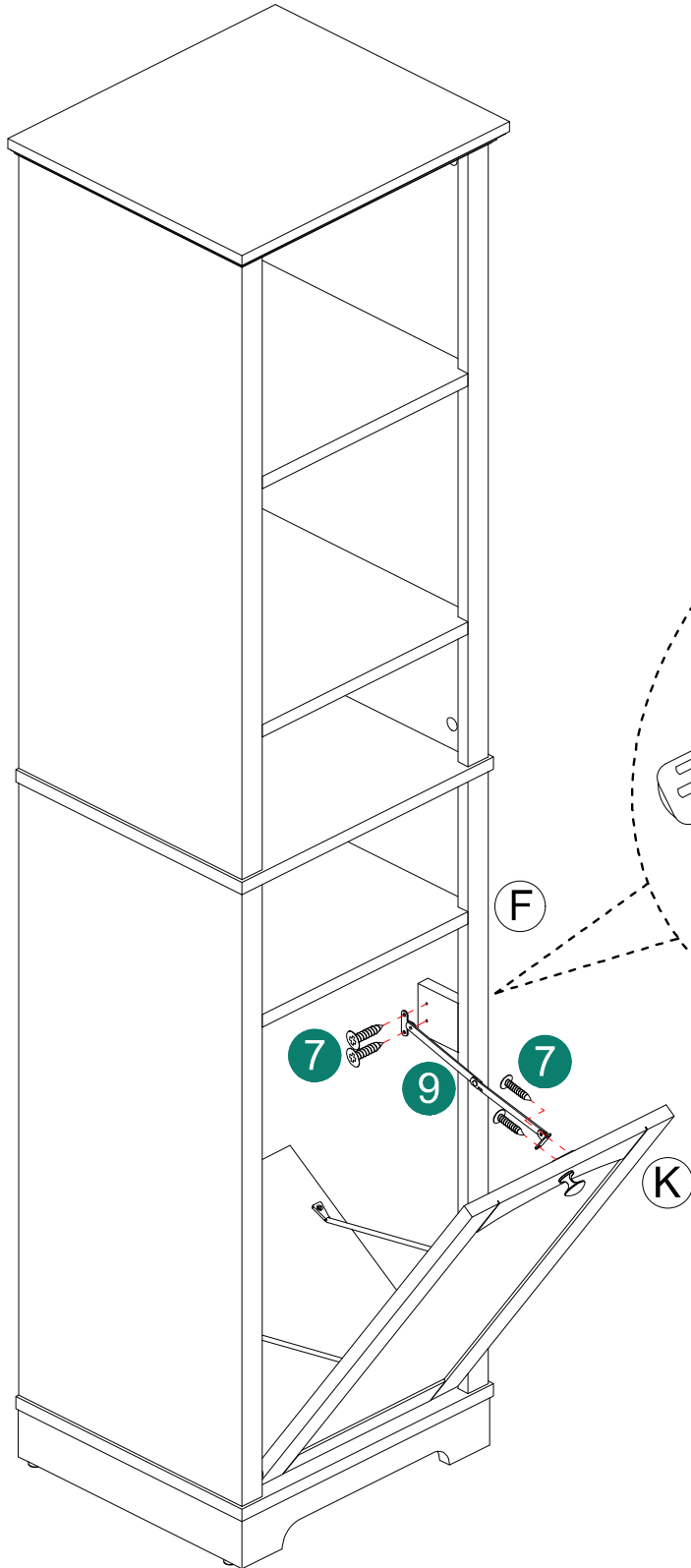
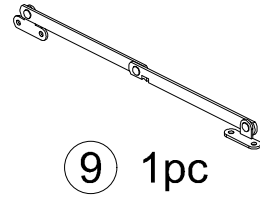
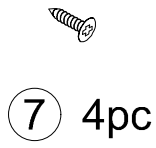

ASSEMBLY INSTRUCTIONS

12

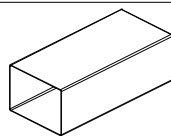

11 1pc

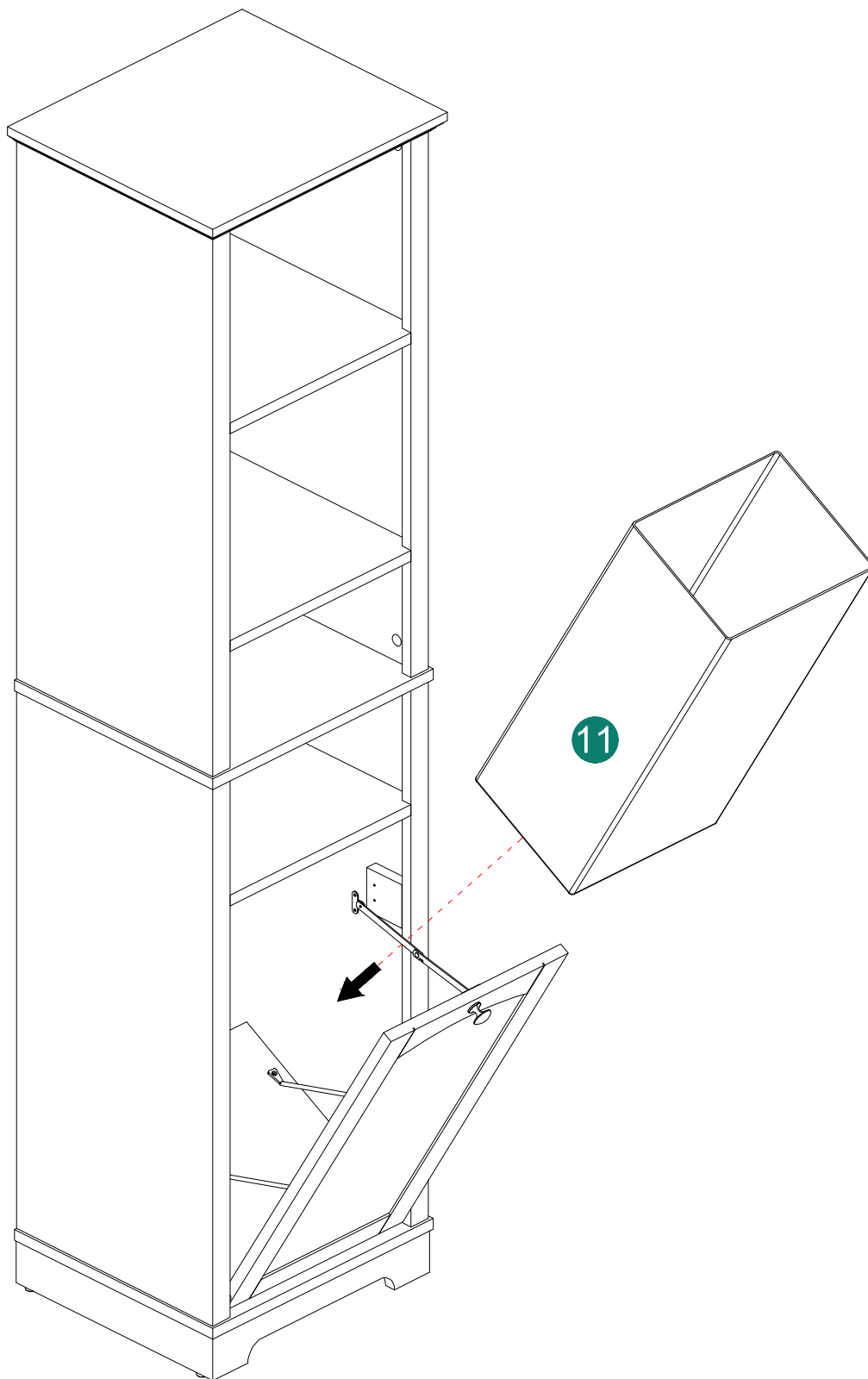

ASSEMBLY INSTRUCTIONS

13

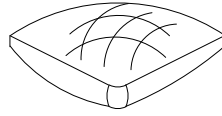

12 1set

A

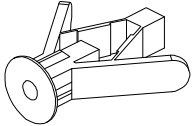

1pc

B

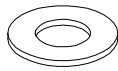

2pcs

C

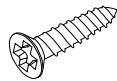

Ø8*Ø4mm*3/4"

1pc

D

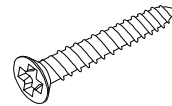

Ø8*Ø4mm*1-1/2"

1pc

E

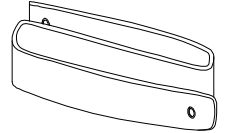

1pc

WALL

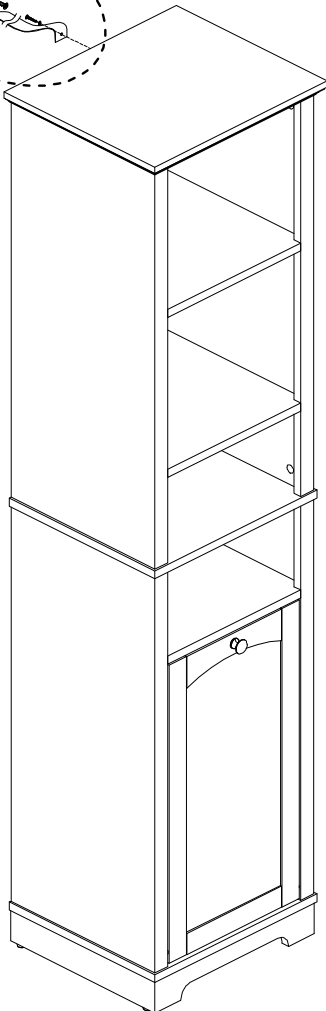
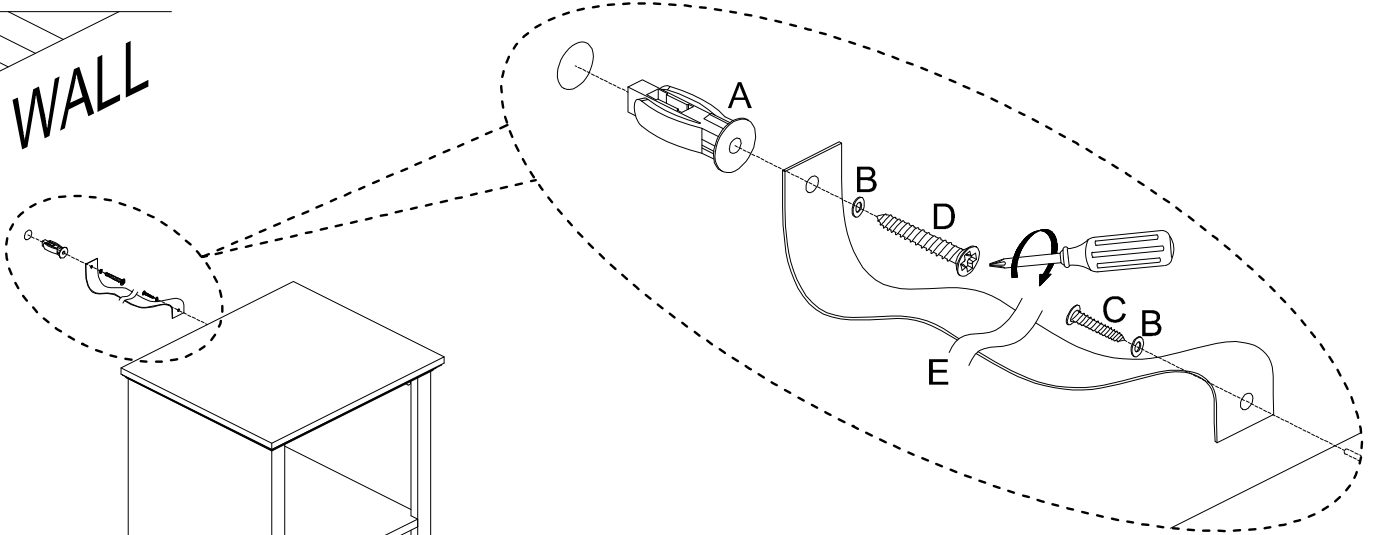

⚠ WARNING

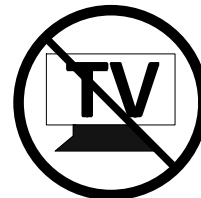

Children have died from furniture tipover. To reduce the risk of furniture tipover:

- ALWAYS install tipover restraint provided.
- NEVER put a TV on this product.
- NEVER allow children to stand, climb or hang on drawers, doors, or shelves.
- NEVER open more than one drawer at a time.
- Place heaviest items in the lowest drawers.

*This is a permanent label.
Do not remove!*