

# Owner Manual

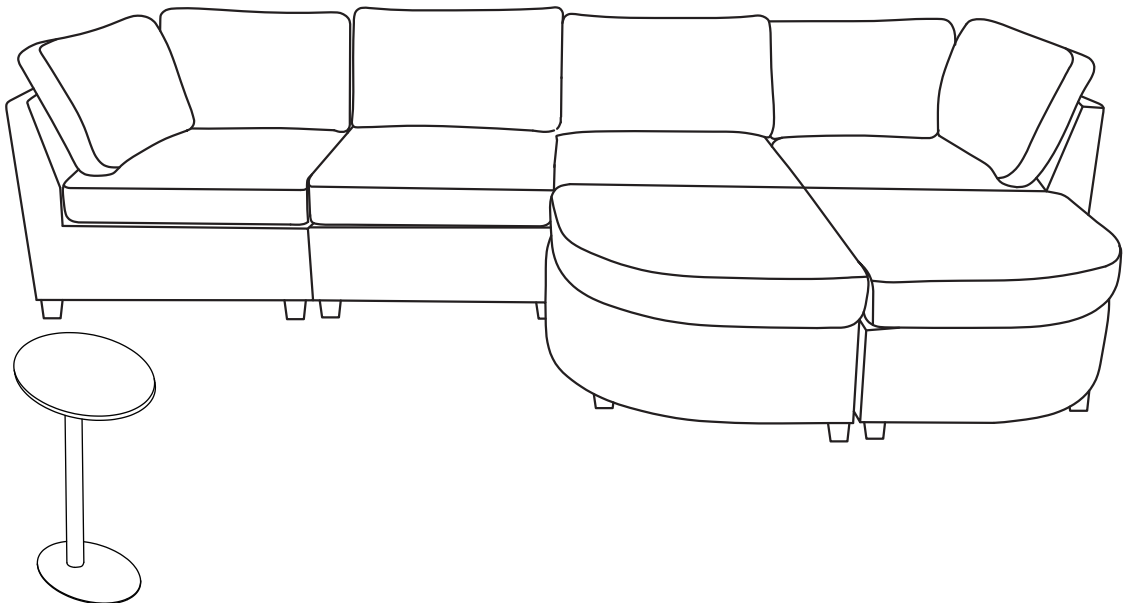

Per Seat Weight Limitation

**1400LBS**

---

Thank You For Choosing Our Furniture

▀ If you have any questions or concerns,  
don't hesitate to reach out to us. ▀

**NOTE:**







This brochure contains  
**IMPORTANT** safety info.  
Please read and keep it  
for future reference.

# MAINTENANCE AND WARNINGS



## Before You Start

***Please follow the steps below:***



-  Un box the package and check if all parts and accessories are complete.
-  Place the parts of the sofa on a flat surface.
-  Ensure the sofa is placed on a stable, flat surface to prevent it from tilting.
-  Avoid placing sharp or heavy objects directly on the sofa to prevent tears or deformation.
-  Follow the assembly instructions provided to attach the cushions, backrest, and armrests securely.
-  Clean the installation area in advance and ensure the ground is level and there is enough space to avoid damaging the furniture or making installation difficult.
-  Lay a protective mat on the ground to prevent scratching the floor during installation.

### ***After-Sales Service***

- If you encounter any issues or need technical support during use, please contact our after-sales team. We offer long-term maintenance and warranty services.





## Precautions

-  This sofa is for indoor use only. Do not expose it to outdoor elements or high-humidity environments.
-  Keep the product away from high heat or open flames to prevent fire hazards.
-  Do not allow children or pets to play on the sofa unsupervised to avoid accidents.



## Safety Warnings





-  If you notice any loose or damaged parts, stop using the sofa immediately and contact customer service.
-  Do not attempt to disassemble or replace any components yourself, as this may affect the stability and safety of the product.

### ***Daily Maintenance***

- Regularly clean the surface of the sofa with a soft cloth to prevent dust accumulation.
- For fabric sofas, it is recommended to vacuum weekly and clean the fabrics as needed.
- For leather sofas, use a leather cleaner regularly to clean and maintain the material. Avoid direct sunlight to prevent leather aging.
- In case of spills, immediately blot the area with a clean, dry cloth

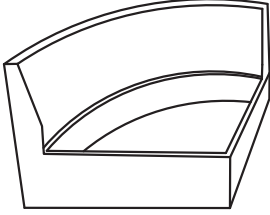
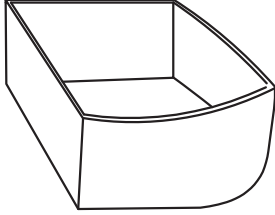
# Parts List

## BOX-A

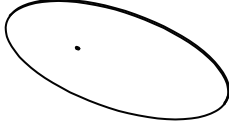
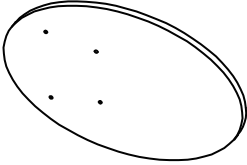
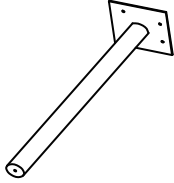
<p><b>A</b></p>  <p>x1</p> <p>Edge position</p>	<p><b>C</b></p>  <p>x1</p> <p>Pedal position</p>
<p><b>D</b></p>  <p>x2</p> <p>Seat cushion</p>	<p><b>G</b></p>  <p>x2</p> <p>Back cushion</p>
<p><b>J</b></p>  <p>x8</p> <p>Legs</p>	<p><b>H</b></p>  <p>x1</p> <p>Table bottom plate</p>
<p><b>I</b></p>  <p>x1</p> <p>Table</p>	<p><b>K</b></p>  <p>x1</p> <p>Table support</p>



Installation:  
30minutes.



Two Person

# Parts List

## BOX-B

A

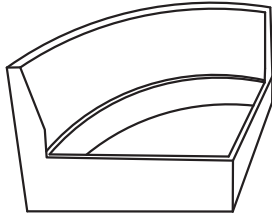

x1

Edge position

C

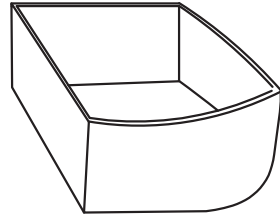

x1

Pedal position

D

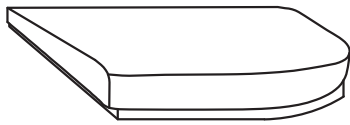

x2

Seat cushion

G



x2

Back cushion

G



x8

Legs

# Parts List

## BOX-C

**B**

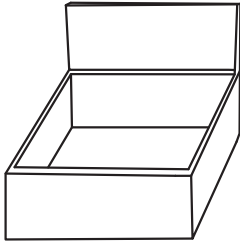

x2

Middle position

**E**

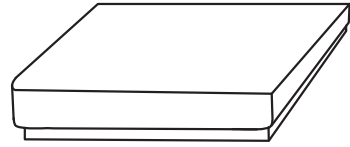

x2

Seat cushion

**F**

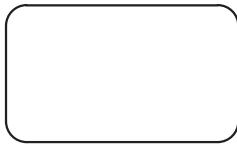

x2

Back cushion

**J**





x8

Legs

# Hardware List

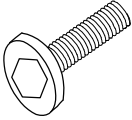
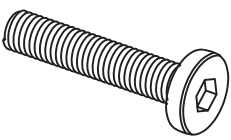
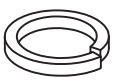
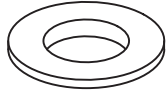
## BOX-A

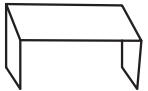
<p>1</p>  <p>x4+1</p> <p>1\4x16MM</p>	<p>2</p>  <p>x1+1</p> <p>M8x25MM</p>	<p>3</p>  <p>x4+1</p>
<p>4</p>  <p>x4+1</p>	<p>5</p>  <p>x1</p>	<p>6</p>  <p>x12</p> <p>Matal shap</p>

# THREE TYPES OF SEATS

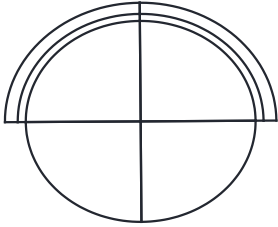

***Type A***  
***Two-Seater***

Page 8-13

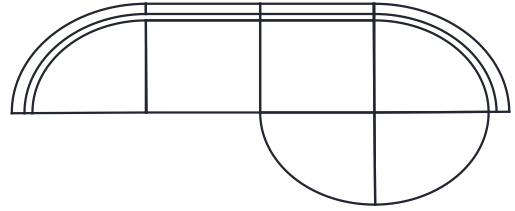



***Type B***  
***Six-Seater***

Page 8-13

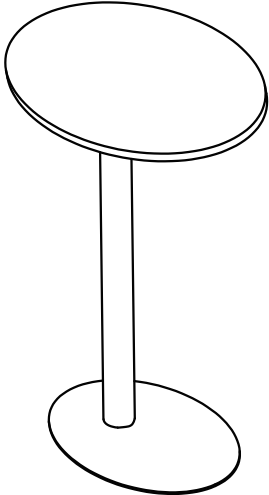
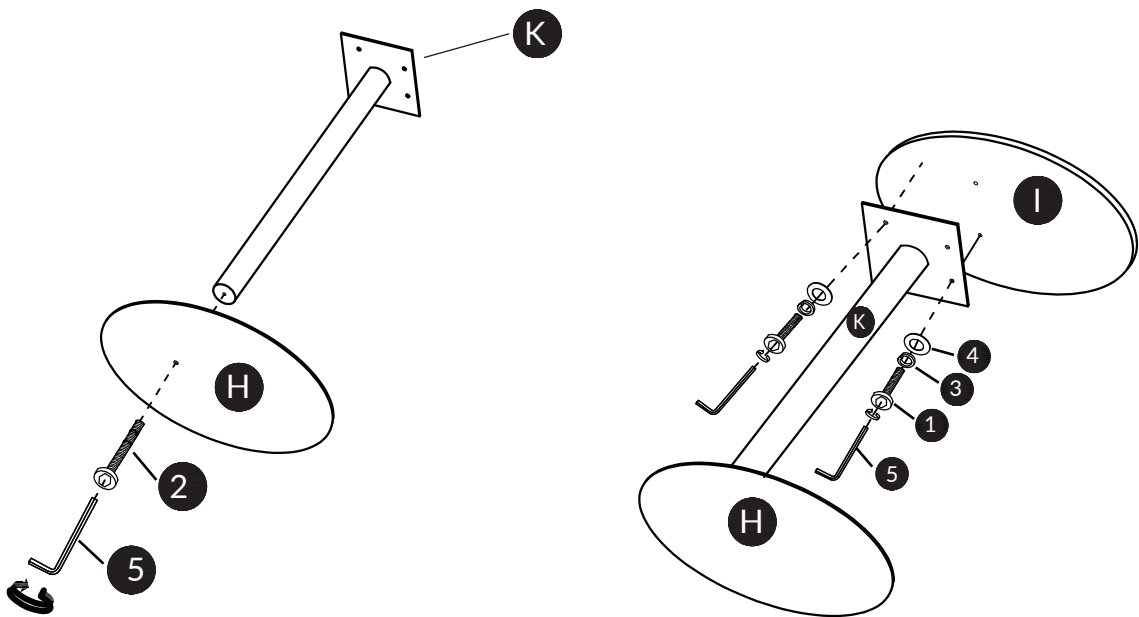
# Step 1

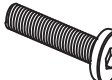
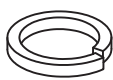

1	x4	2	x1	3	x4	4	x4	5	x1
									
1\4x16MM		M8x25MM							

# Step 2

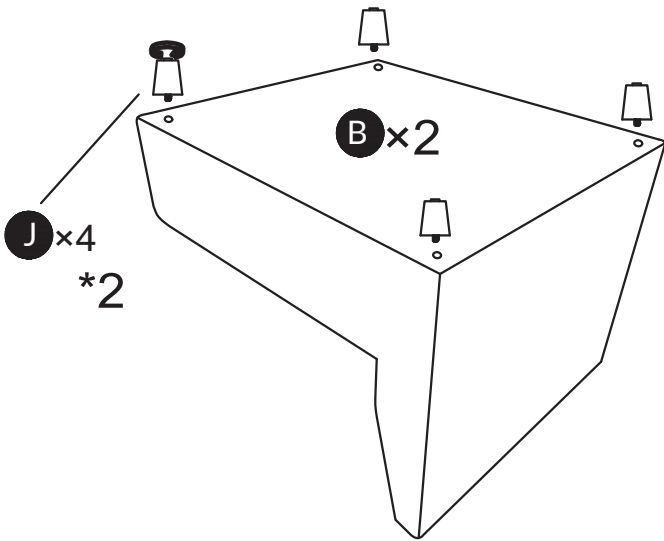
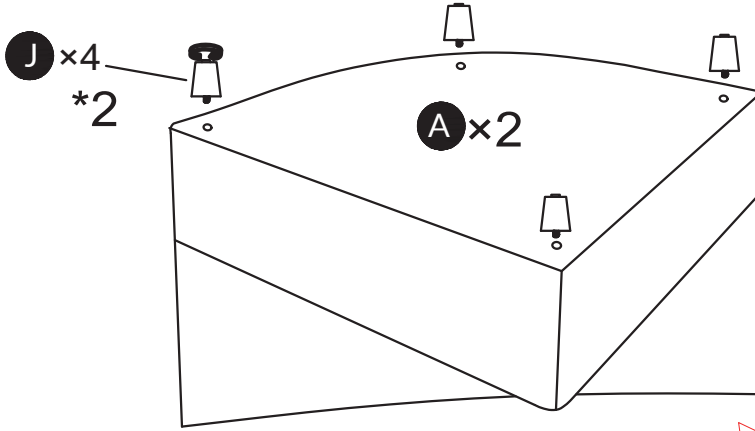

Facedown seat frame  
(A/B/C) x 2

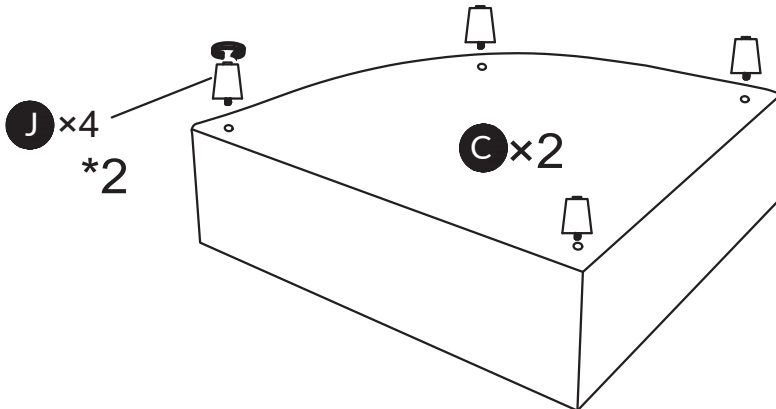

### Step 3

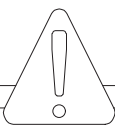

Both Edge position and Edge position are side-to-side interchange.

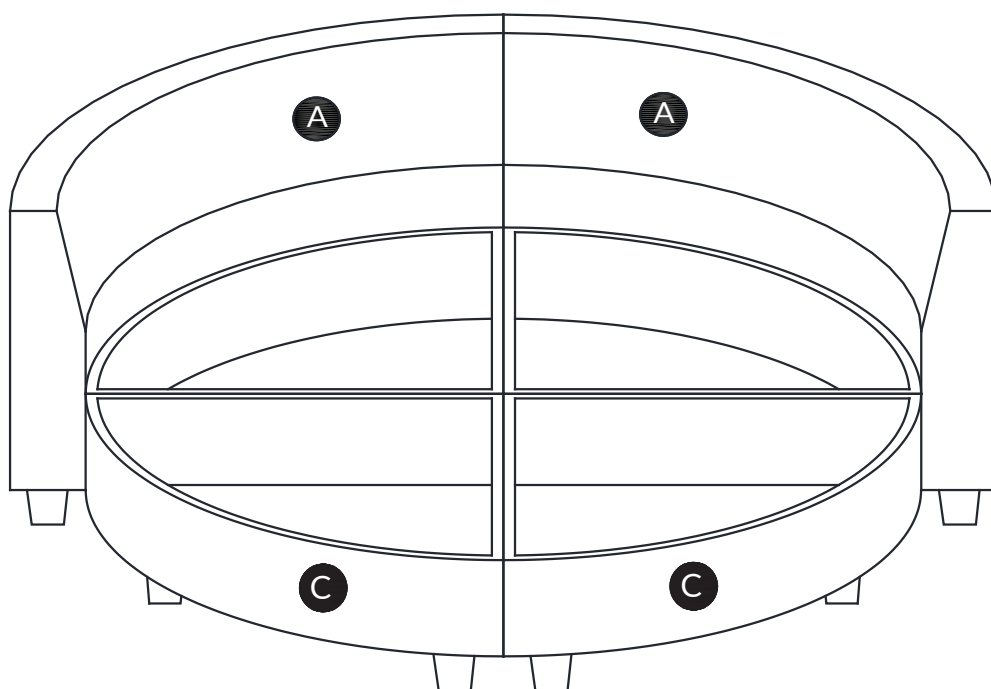
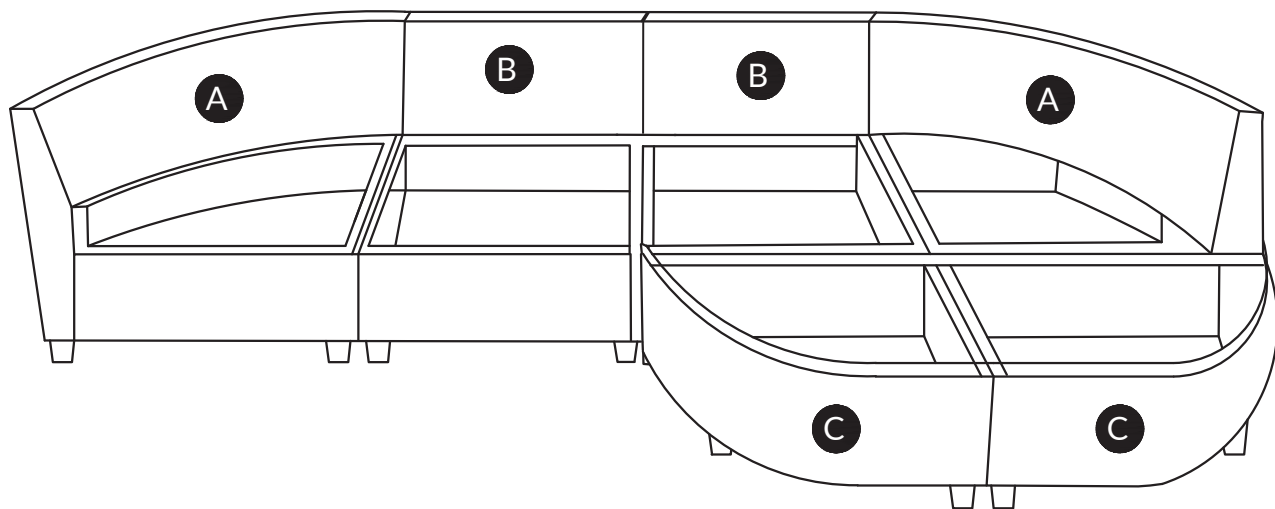

# Step 4



Secure the ABCs with metal clasp

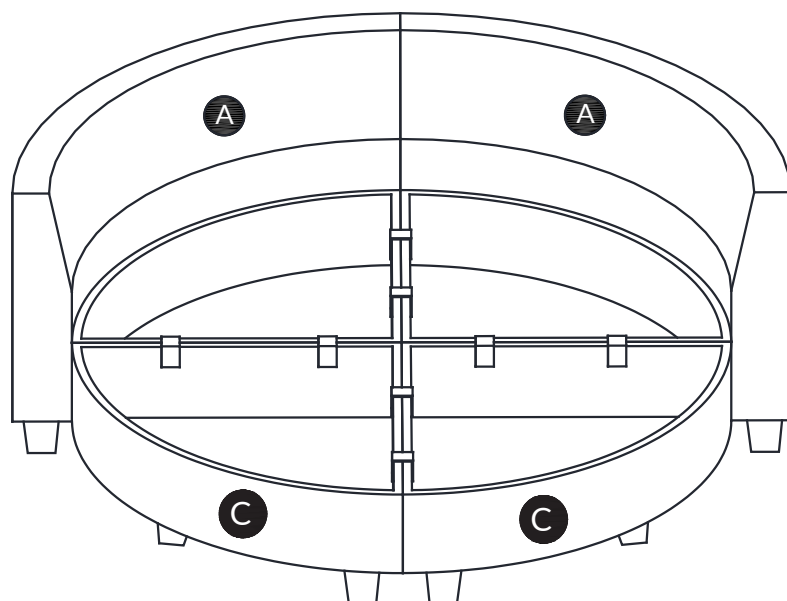
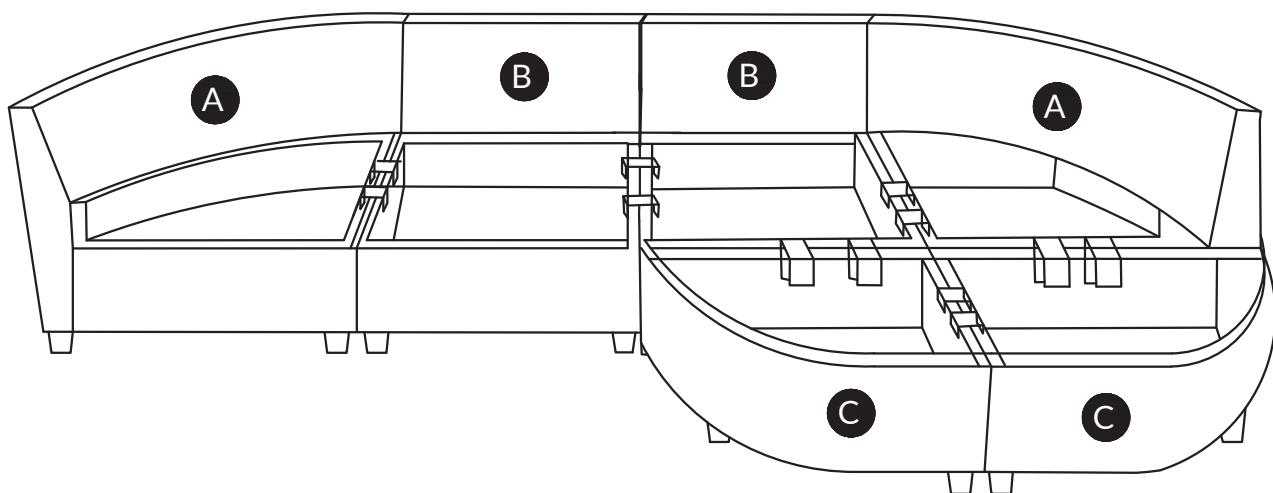

1	x12
Metal shap	

# Step 5

  
Edge position and Edge position's  
Seat cushion are interchangeable.

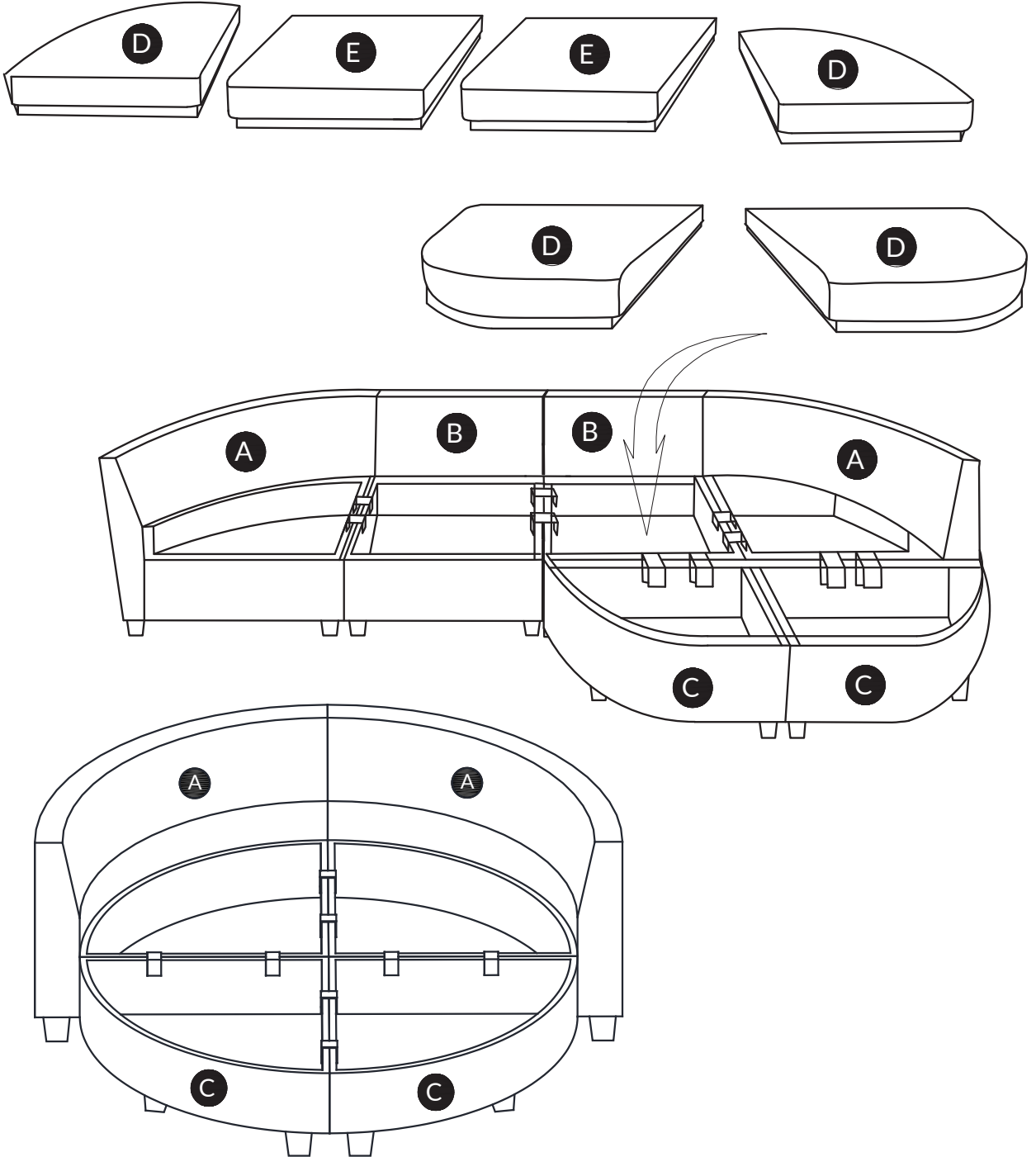

## Step 6

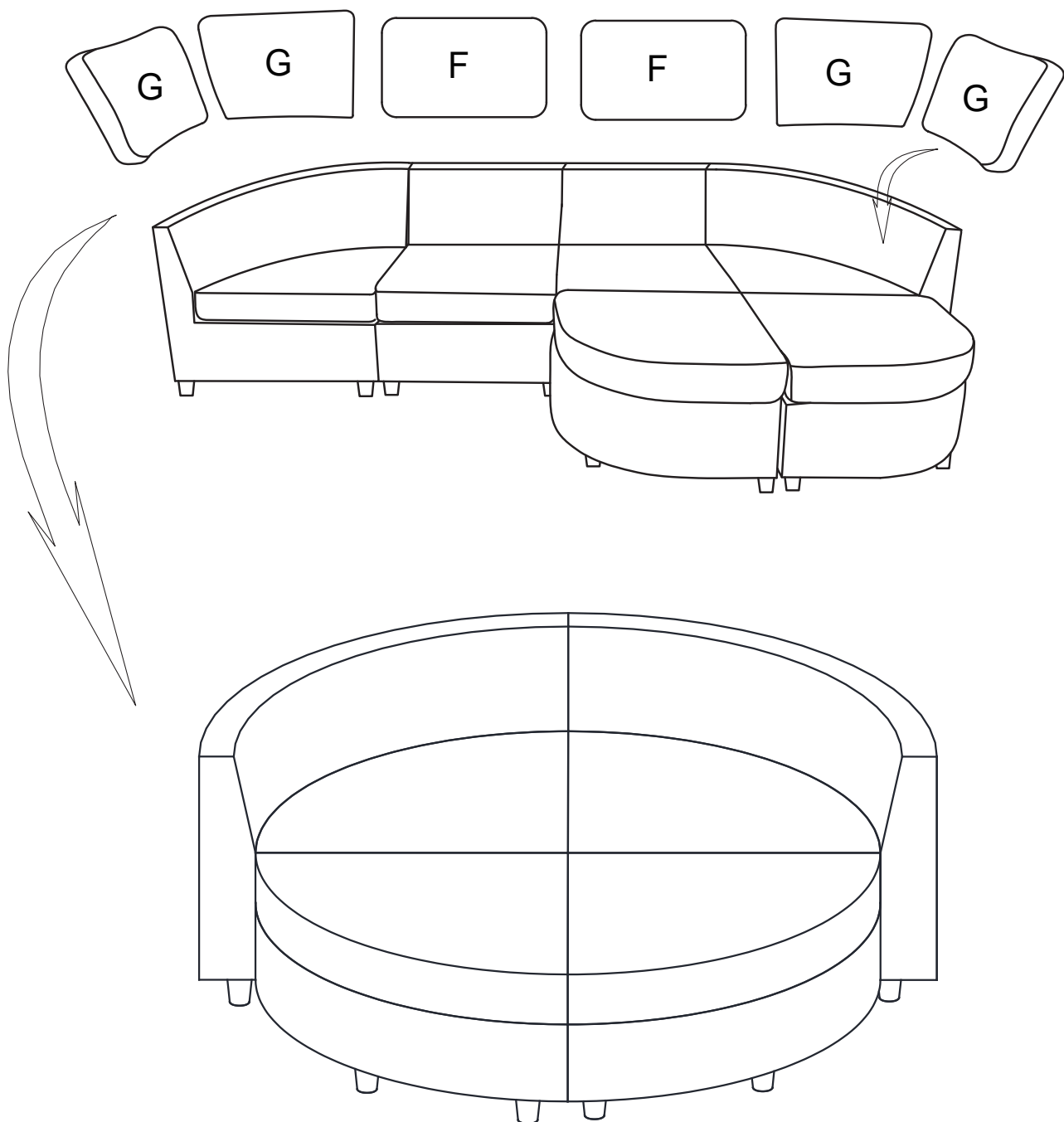

# Step 7

## Assemble Step-A

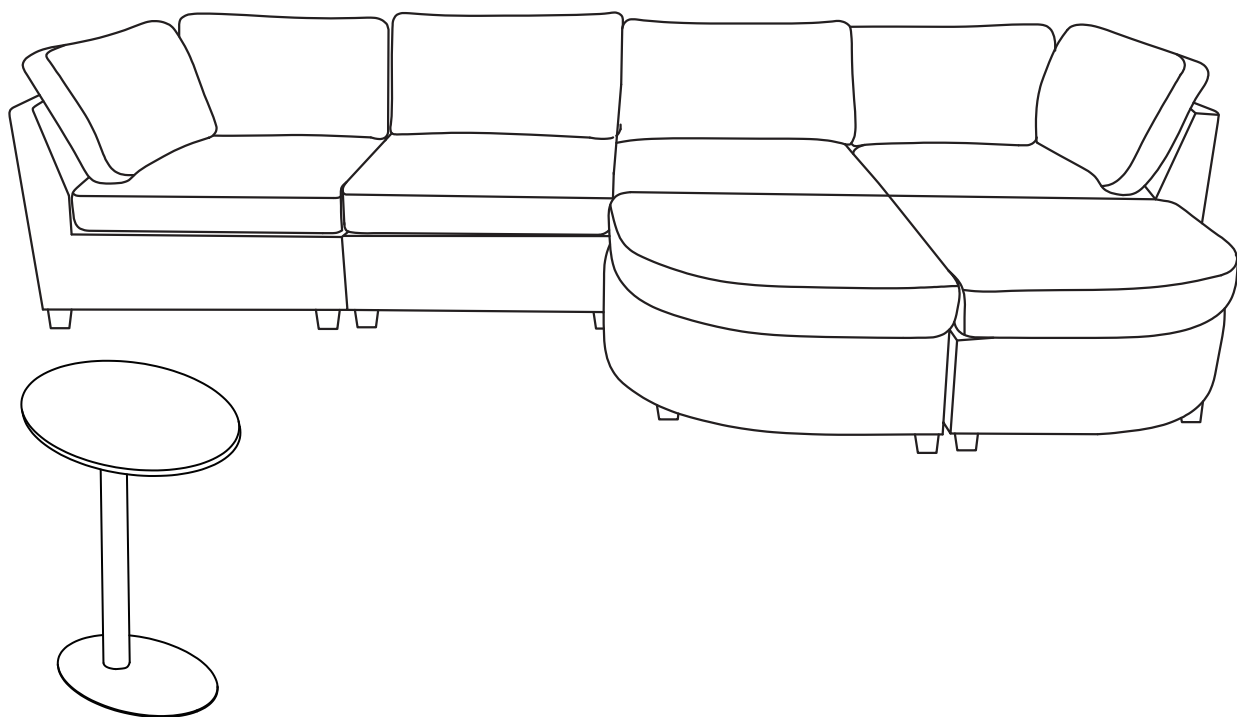

## Assemble Step-B

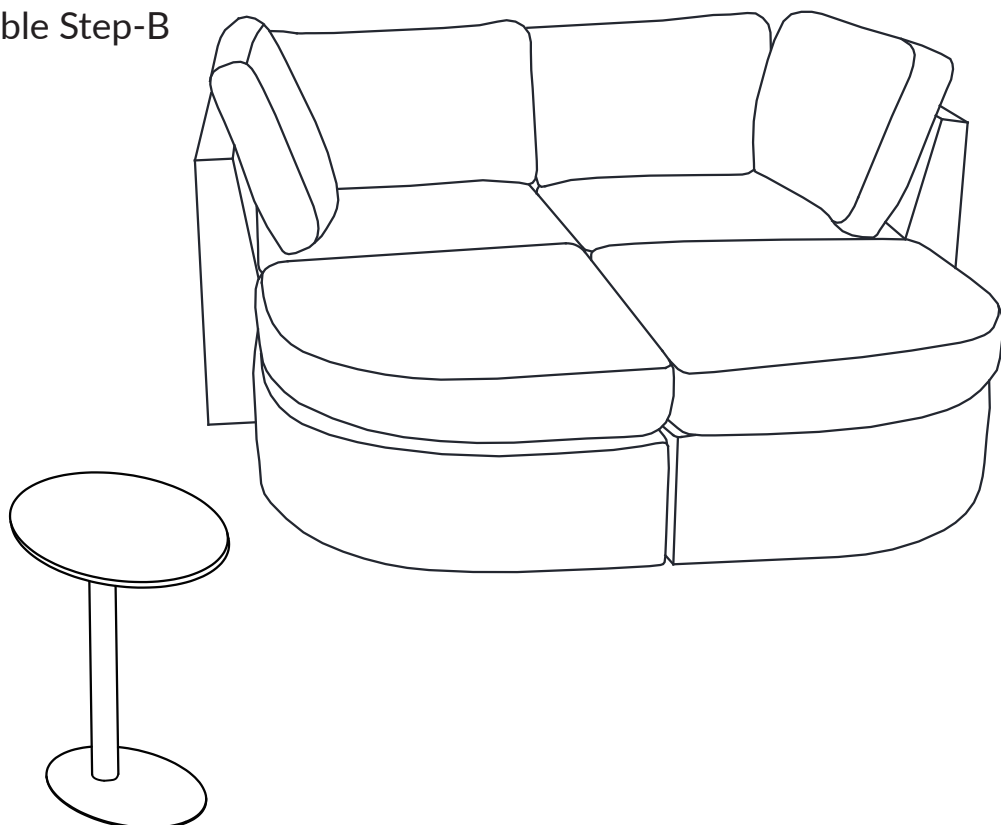

# WARRANTY

- We strive to offer quality products, and we also try our best to satisfy every customer who orders from us with products or services as needed.
- We provide 30 days warranty starting from the time you receive the item. Each customer must provide a record of their orders such as the order number, or item receipt for any items that are out of the warranty period you may also still receive.
- Replacement parts by purchasing them from our company if they are available.
- For return, please check the return policy with the retailer or market place you bought from