













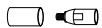

Parts & Hardware Included:

Product Model : floor lamp

Picture	Description	Qty	Check list
	Crown beauty	1	A
	Ø100 perforated cover	1	B
	Ø370*170mm Shelving lamp shade	1	C
	Ø16*250 inner teeth rod	1	D
	Ø30*50 light cup With E12 lamp holder	3	E
	Ø100 round pieces	1	F
	Ø100 flying saucer	1	G
	Ø19*800 inner teeth rod	1	H
	Flower branch fastener	1	I
	Ø28*800 inner teeth rod	1	J
	Ø28 single connector	1	K
	Ø150 round pieces	1	L
	Ø350*35 marble lamp holder	1	M
	Ø145*130 iron wire light holder	1	N
	Ø145*130 iron wire light holder	1	P

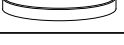

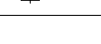
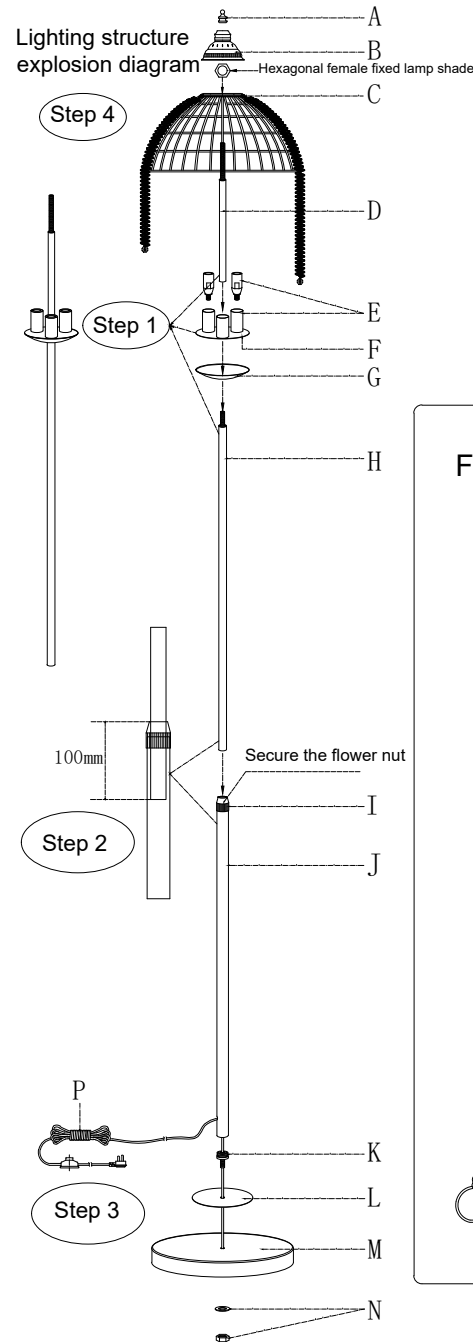
Crystal Installation instructions
 1: Put the wire rack on the D rod
 On the dental canal, and then use the hex female lock
 Secure the shelf and double the length
 Kinds (18 each) crystal string staggered
 Put it on the shelf and put the lid B
 Put it on the canal, then use A
 The piece is locked.

Step 4

Floor lamp

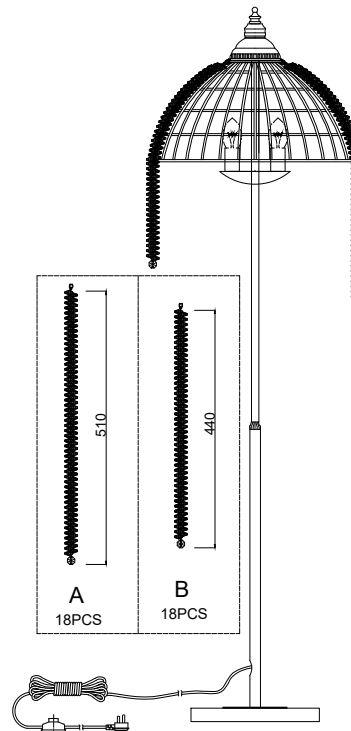

Installation procedure

- Carefully disassemble and identify each part to ensure that you are ready
 To install everything, place each part on a clean flat surface, such as a table
 Son or floor.
- Cut off the main power supply to the fuse box or circuit breaker in the house or building.
- Installation steps (as prompted on the left)
 Step 1: (Install and connect the D-E-F-G-H) accessories.
 Step 2: Follow the instructions on the left to install.
 Step 3: Connect the marble lamp holder to install and tighten.
 Step 4: Install and tighten the shelf crystal cover as prompted.
- Install the light source, connect the power supply, step on the switch on the switch line to test the light.
 Save these instructions for future use.
 If the lights don't work, you can contact our customer service team
 Solve the problem
- Maintenance methods
 Clean the water with a soft dry cloth or an electrostatic duster
 Avoid using harsh chemicals and abrasives to clean the fixture and smooth the surface
 Deal.
- Use safety precautions
 Your light is in the water, which will damage the wiring.
- After-sales questions can be contacted on the platform order page
 We hope you enjoy your new lighting as much as if your project achieved
 Or exceed your expectations, we will be honored if you write us one
 A review that shares your experience can help others and other customers get to know you
 The idea. To your support like this we make money and we really appreciate it.
- Finger mold and sweat left on the metal and crystal surface of the lamp body after installation
 The trace can be cleaned with a soft dry cloth or an electrostatic duster.

Step 2

Height adjustment Instructions (recommended)
 Loosen the fixed flower nut counterclockwise first
 Then adjust the upper rod down 100mm and then fix it
 The flower branches can be tightened clockwise,
 of course
 Can be adjusted to your preferred height.