

HAPPINESS HAPPINESS INSTALLATION

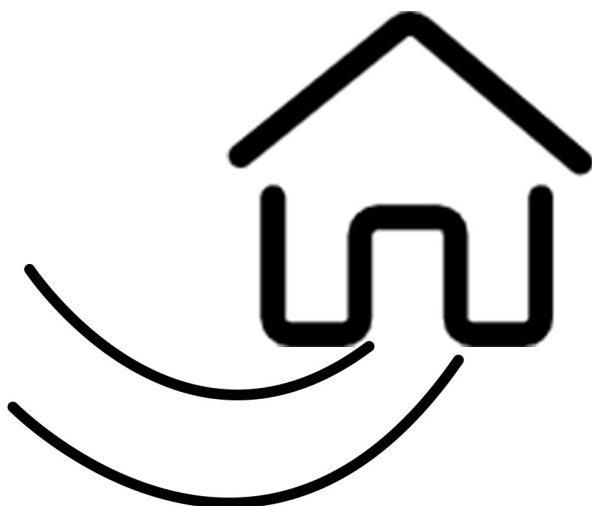

CAUTION

Parts are placed at the bottom of the product.







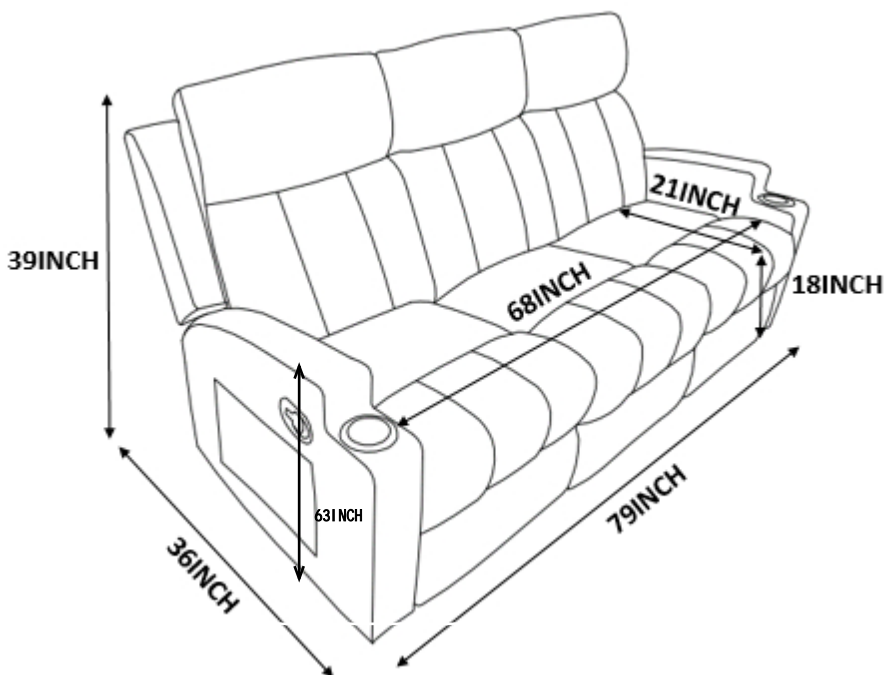
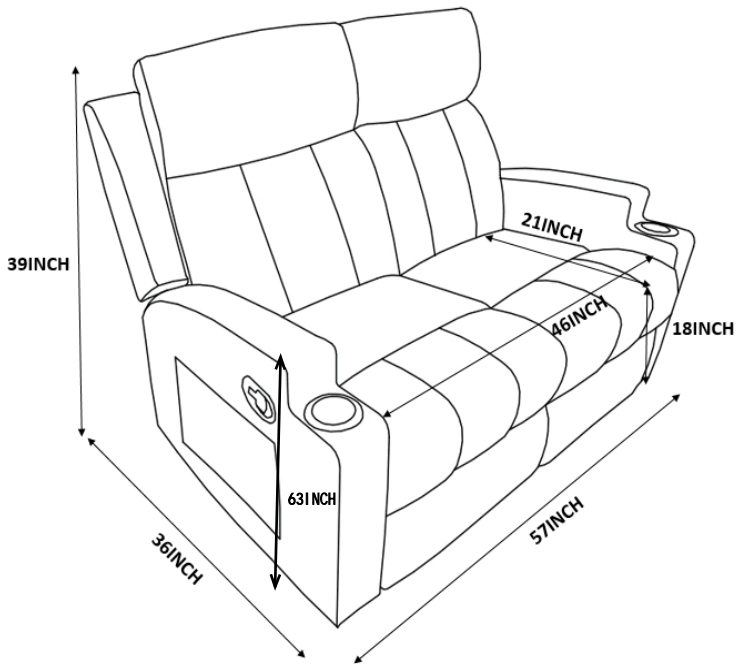





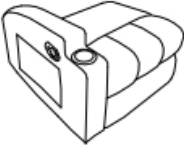

Assembly Instructions

CAUTION

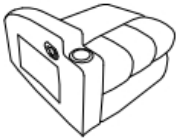
DO NOT use any sharp objects to open plastic-wrapped components as this may result in damage to the product or components.

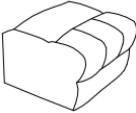

Package Contents

| | | | |
|---|---|---|--|
|  |  |  | |
| A*1 | E*1 | C*1 | |
|  |  |  | |
| B*1 | F*1 | D*1 | |
|  |  |  | |
| A*1 | E*1 | C*1 | |
|  |  | | |
| G*1 | H*1 | | |
|  |  |  | |
| F*1 | B*1 | D*1 | |
| | | | |
| | | | |
| | | | |
| | | | |
| | | | |
| | | | |

STEP1:

Assemble the **Back(A&B&G)** to its **Seat(C&D&H)**, making sure it is securely installed before use.

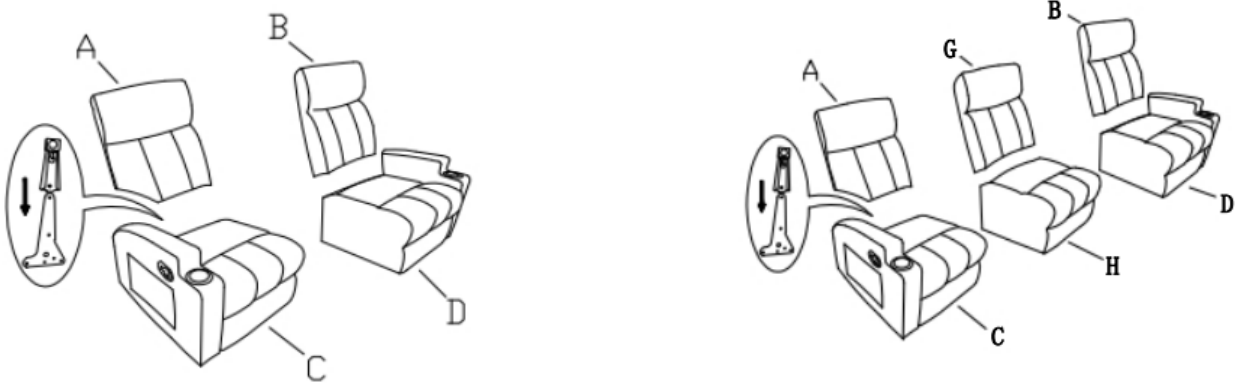

STEP2:

Attach **Seat(C&D&H)** by aligning the metal grooves on seat to seat as shown.

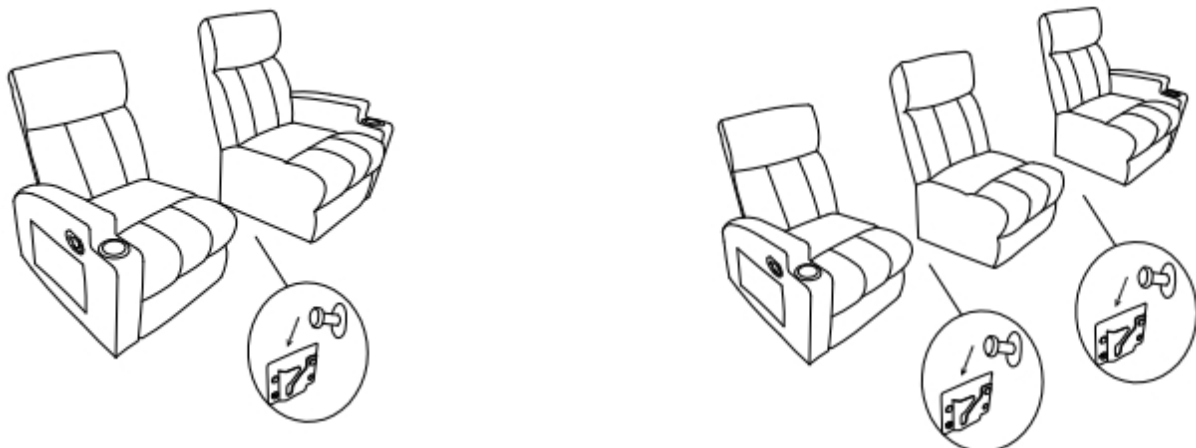

STEP3:

Install the **Ears (E&F)** to its **Back(A&B)** via aligning the metal grooves, making sure it is securely installed before use.

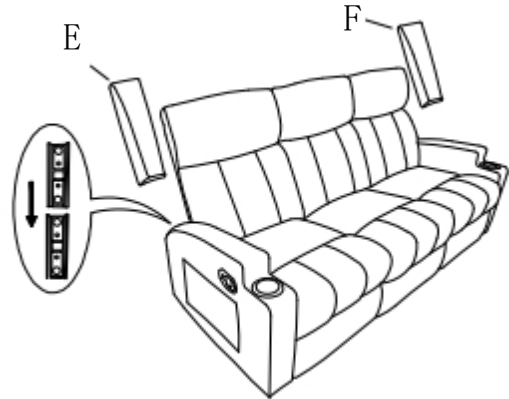
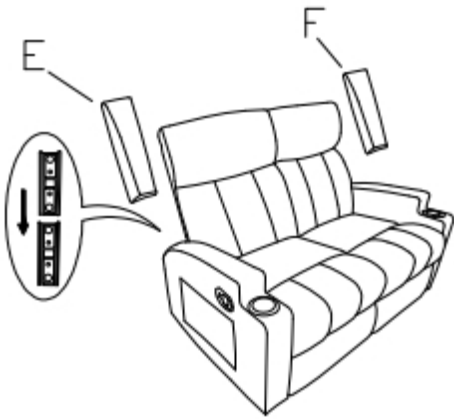

ASSEMBLY COMPLETED



Loveseat

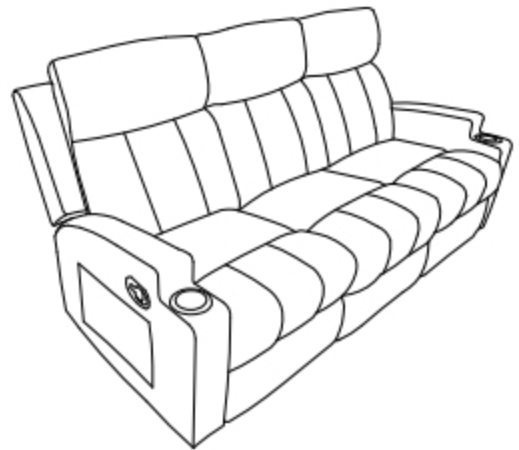

Sofa

Note:

Ensure the backrest is fully inserted to the bottom along the metal slot to avoid tilting or moving. And please not sit on the armrests for the user's safety.

Warnings

1. Please check if the components of the chair are all included and can be used normally.
2. Assemble all components according to the instruction correctly before you connect the chair to the power.
3. Please DO NOT sit on the armrests or footrest to eliminate the risk of tipping over.
4. If the chair is damaged or doesn't match the website description, please send clear pictures of the product and label of the carton to our service team for further help.
5. If the recliner doesn't work, you may try the following measures for self-checking firstly:
 - a) Check if all the cables are connected;
 - b) Check if the light of transformer is on.

If the chair still doesn't work, please feed the information back to our customer service in time and we'll help you solve the matter as soon as possible.

