



**INSTRUCTIONS D'ASSEMBLAGE  
ASSEMBLY INSTRUCTIONS**

---

---

**TABLE D'APPOINT -  
44"L / TAUPE FONCE / VERRE TREMPE**

**ACCENT TABLE -  
44"L / DARK TAUPE / TEMPERED GLASS**



**POUR DE L'ASSISTANCE OU POUR COMMANDER  
DES PIÈCES CONTACTEZ NOTRE DÉPARTEMENT  
DE SERVICE À LA CLIENTÈLE.**

**FOR ASSISTANCE OR TO ORDER PARTS  
CONTACT OUR CUSTOMER SERVICE DEPARTMENT**

## LISTE DES PIÈCES PARTS LIST

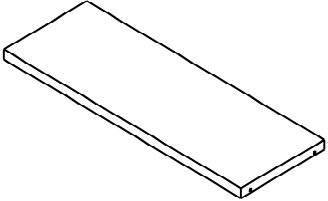
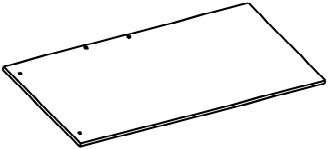
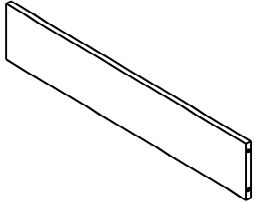
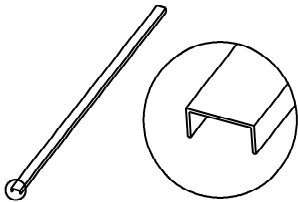
PIÈCE / PART #	IMAGE	DESCRIPTION	QTY / QTÉ
<b>1</b>		<b>TABLE TOP SURFACE DE TABLE</b>	<b>1</b>
<b>2</b>		<b>GLASS PANEL PANNEAU EN VERRE</b>	<b>2</b>
<b>3</b>		<b>SUPPORT PANEL PANNEAU DE SOUTIEN</b>	<b>1</b>
<b>4</b>		<b>PLASTIC BAR BARRE DE PLASTIQUE</b>	<b>2</b>

## LISTE DES PIÈCES DE MONTAGE HARDWARE LIST

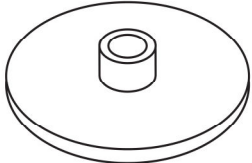
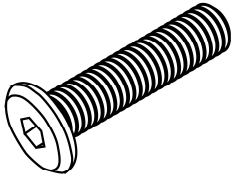
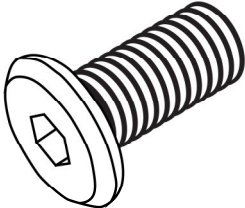
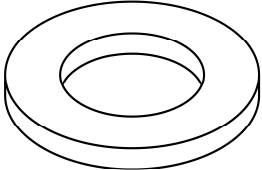
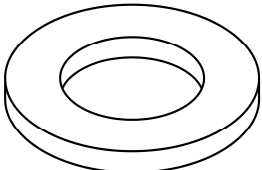
PIÈCE / PART #	IMAGE	DESCRIPTION	QTY / QTÉ
<b>A</b>		SCREW CAP - Ø1/4" X 1 3/8" CAPUCHON DE VIS - Ø1/4" X 1 3/8"	4
<b>B</b>		ASSEMBLING BOLT - Ø1/4" X 1 7/8" BOULON D'ASSEMBLAGE - Ø1/4" X 1 7/8"	4
<b>C</b>		ASSEMBLING BOLT - Ø1/4" X 1 1/2" BOULON D'ASSEMBLAGE - Ø1/4" X 1 1/2"	4
<b>D</b>		PLASTIC WASHER - Ø3/8" RONDELLE DE PLASTIQUE - Ø3/8"	4
<b>E</b>		PLASTIC WASHER - Ø1/4" RONDELLE DE PLASTIQUE - Ø1/4"	4

**LISTE DES PIÈCES DE MONTAGE**  
**HARDWARE LIST**

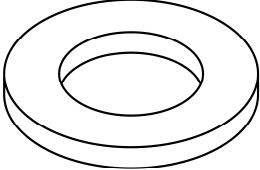
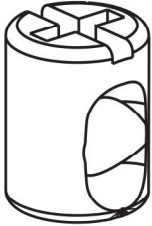
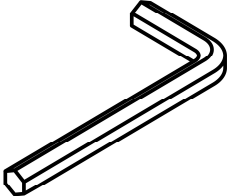
PIÈCE / PART #	IMAGE	DESCRIPTION	QTY / QTÉ
<b>F</b>		<b>METAL WASHER -</b> <b>Ø1/4"</b> <b>RONDELLE DE MÉTAL -</b> <b>Ø1/4"</b>	<b>4</b>
<b>G</b>		<b>BARREL NUT -</b> <b>Ø3/8"</b> <b>ÉCROU DE CANON -</b> <b>Ø3/8"</b>	<b>4</b>
<b>H</b>		<b>HEX KEY</b> <b>CLÉ HEXAGONALE</b>	<b>1</b>

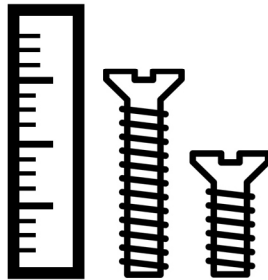

OUTIL DE VÉRIFICATION DE DIMENSIONS DES PIÈCES  
HARDWARE DIMENSIONS VERIFICATION TOOL



ÉTAPE / STEP 1

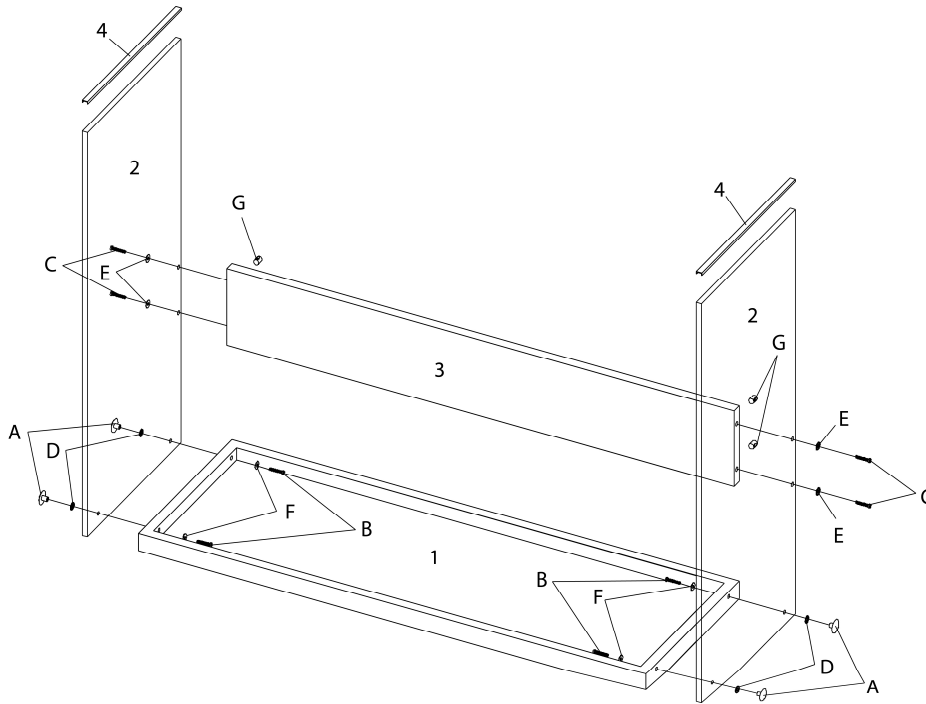

ÉTAPE / STEP 2

