

# BULKHEAD LIGHT

## Assembly Instructions



### CAUTION

- Inspect the wire insulation for any cuts, abrasions, or exposed copper that may have resulted during shipping. If there is a defect in the wire, do not attempt installation.
- Before starting installation of this fixture or removal of a previous fixture, disconnect the power by turning off the circuit breaker or by removing the fuse at the fuse box.

### TOOLS REQUIRED



Ladder



Safety glasses



Electrical tape



Phillips screwdriver



Flat blade screwdriver



Pliers

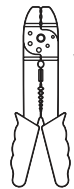

Wire strippers

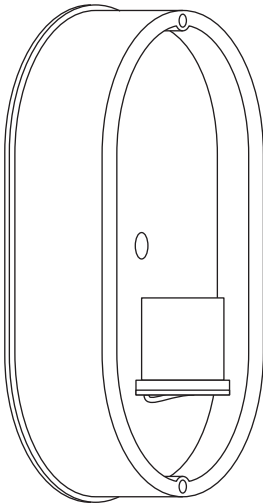

Fixture

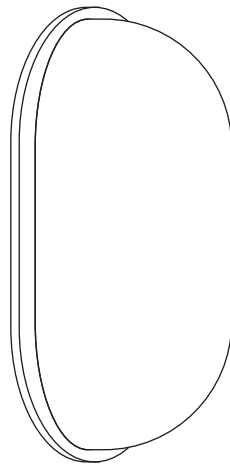

Diffuser

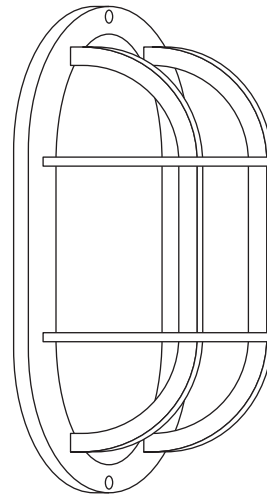

Cage

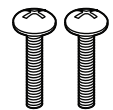

Cage Screws

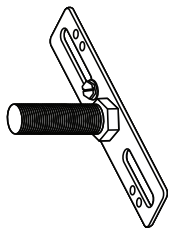

Mounting Unit

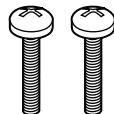

Mounting Screws

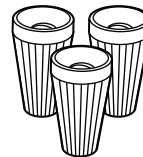

Wire Nuts



Lock Nut

**\*PARTS SHOWN MAY DIFFER SLIGHTLY PER LIGHT FIXTURE**

# BULKHEAD LIGHT

## Assembly Instructions

### STEP 1

Use the **mounting screws** to attach the **mounting unit** to the junction box.

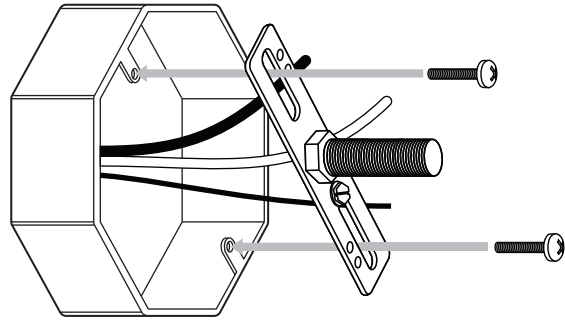

### STEP 2

Make the electrical connection from the junction box to the **fixture**. Connect the ground wire to the **mounting unit** using the preinstalled green ground screw. Then, connect the positive, negative and ground wires with the supplied **wire nuts**. Secure with electrical tape.

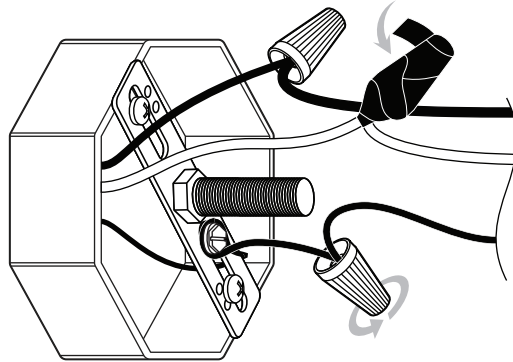

Connect Clear, Brown, Gold or Black Parallel Wire without tracer (round & smooth) or Black Fixture Wire to:

Black or Red Supply Wire or Insulated Wire (other than green) with copper conductor.

Connect Clear, Brown, Gold or Black \*Parallel Wire with tracer (square & ridged) or White Fixture Wire to:

White Supply Wire or Insulated Wire (other than green) with silver conductor

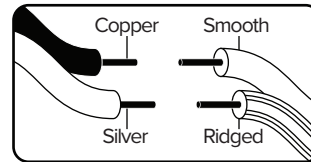

### STEP 3

Place the **fixture** over the **mounting unit** and secure with the **lock nut**. Install a bulb (not included) and cover with the **diffuser** and **cage**. Secure the assembly with the **cage screws**.

