

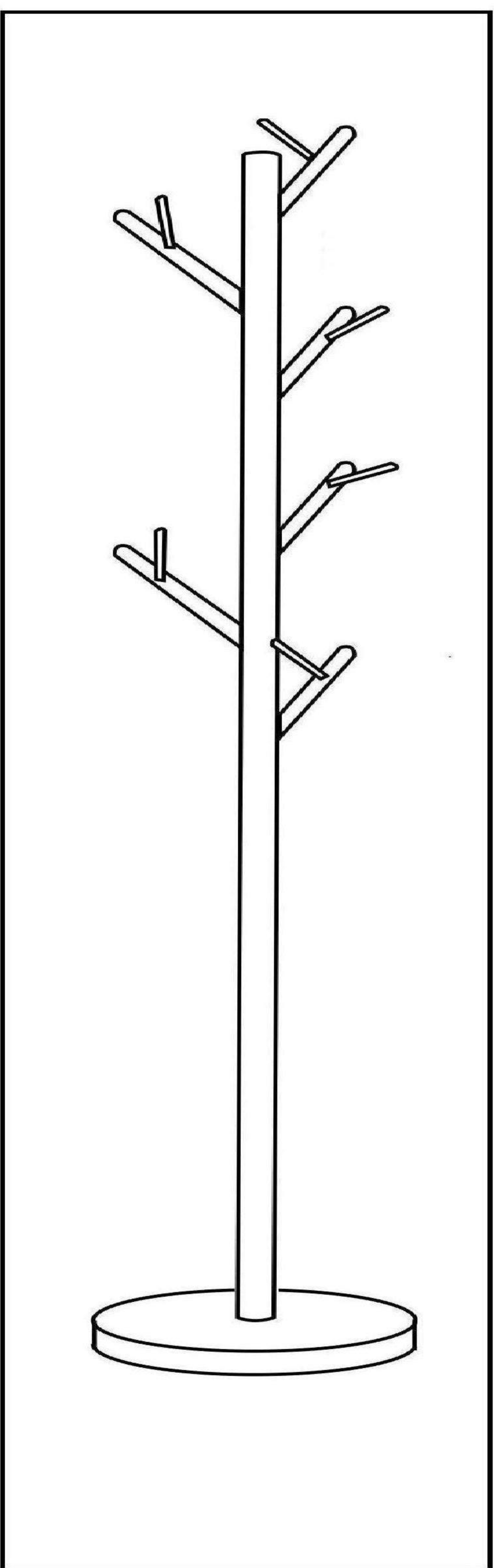

# ASSEMBLY INSTRUCTIONS INSTRUCTION D'ASSEMBLAGE

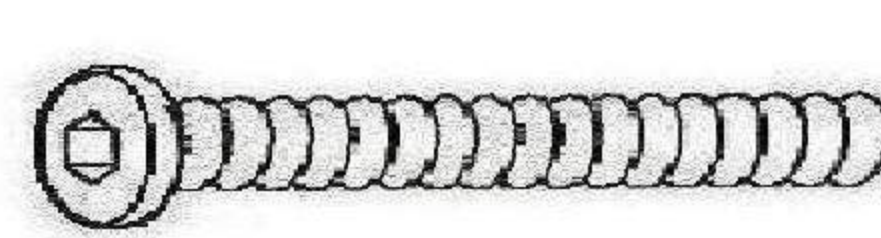

-   
 38 mm  
**A - 1**
-   
 25 mm  
**B - 1**
-   
 10 mm  
**C - 12**
-   
**D - 1**
-   
 56 mm  
**E - 1**
-   
**F - 1**
-   
**G - 6**
-   
**H - 6**

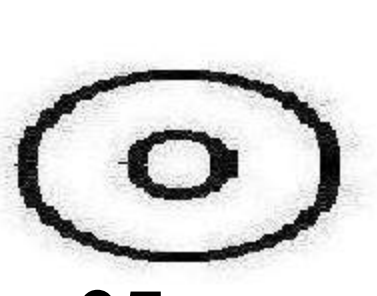
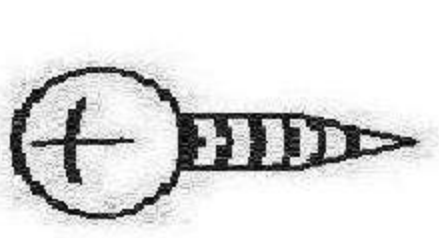
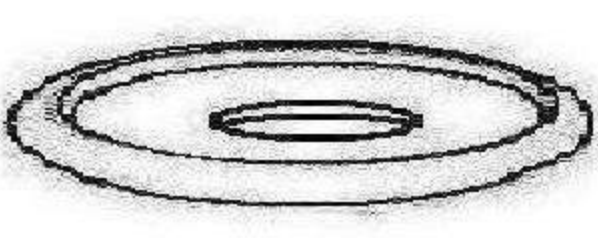
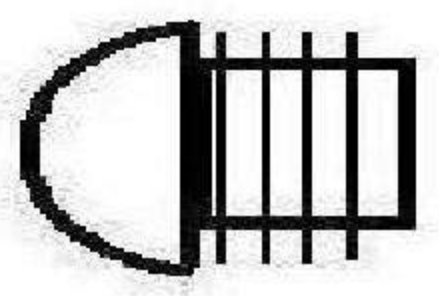
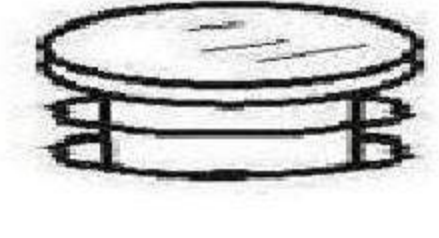