

ASSEMBLY INSTRUCTIONS

Item Number **N601P375917**
N601P375918

This set comes in 2 boxes. If you do not receive a full 2 boxes, please contact our customer service.

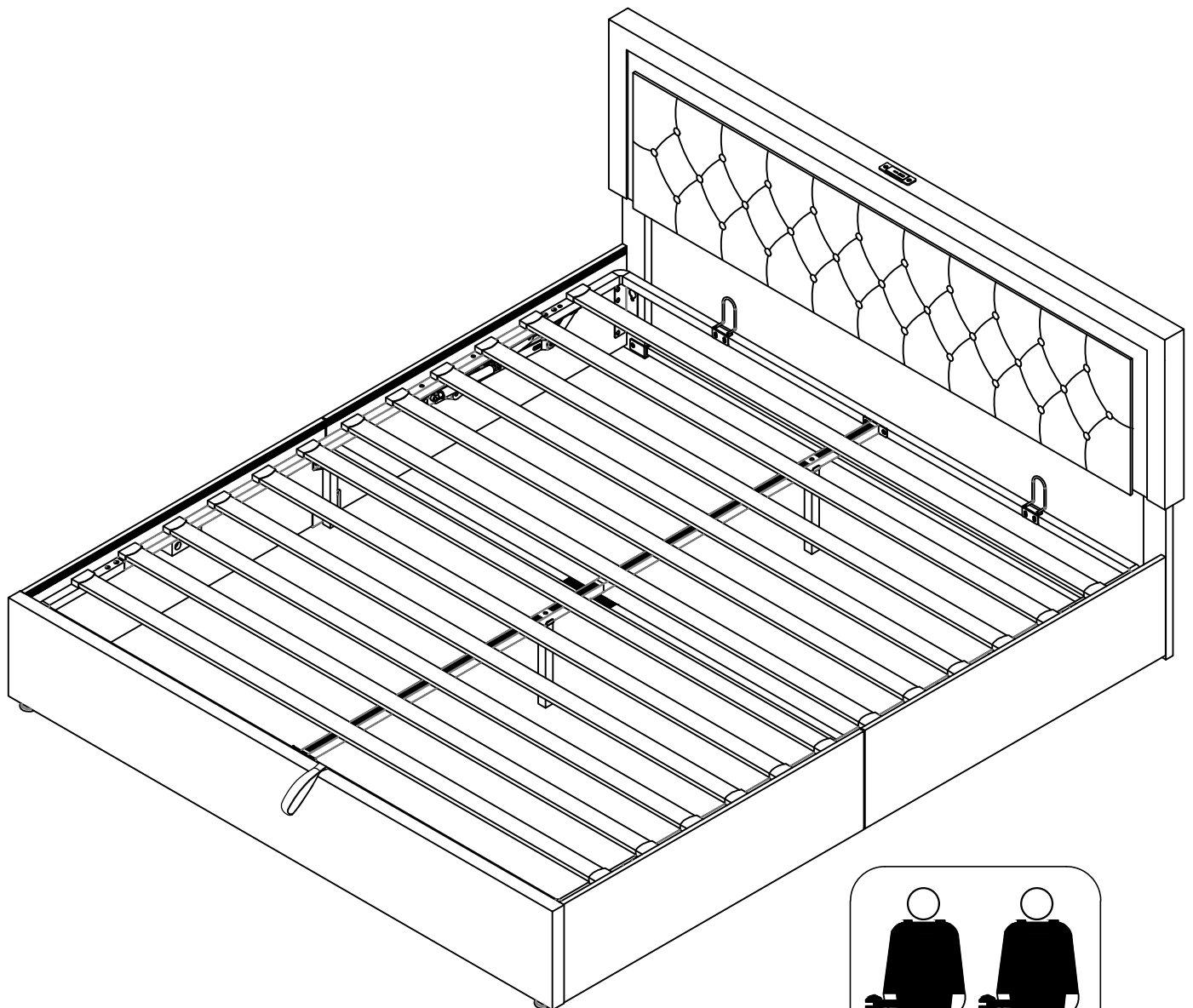



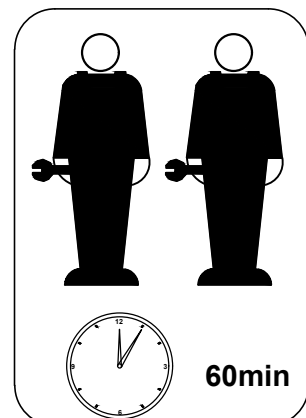

Upholstered bed-180*200CM



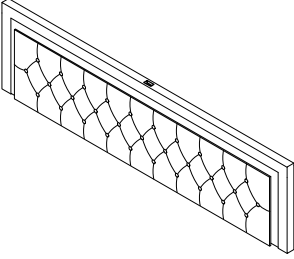
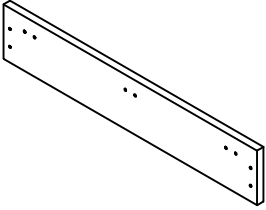
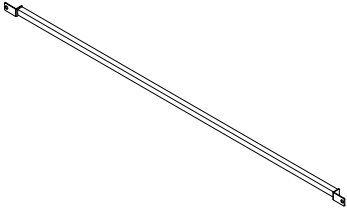
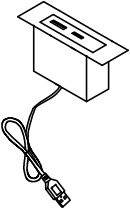
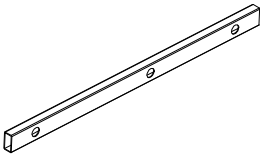
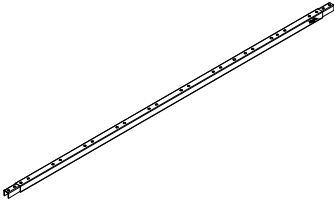
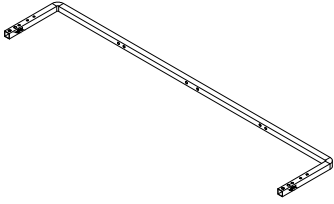
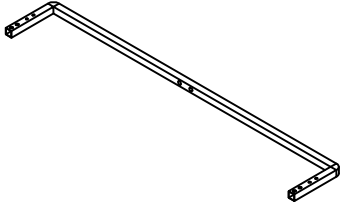
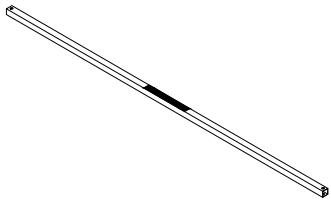

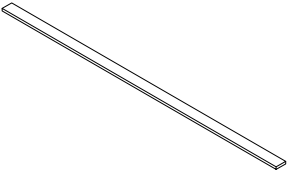
**UK
CA**

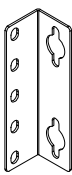
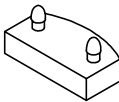
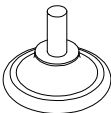
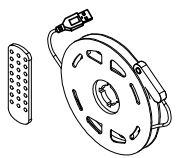
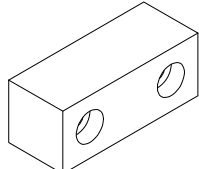
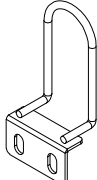



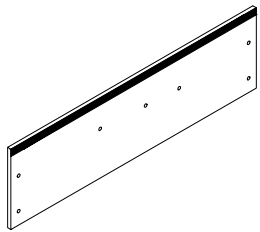
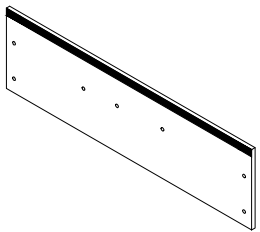
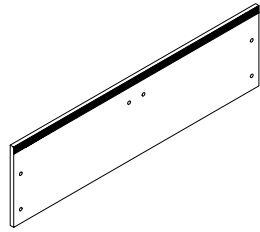

Part list N601P375917

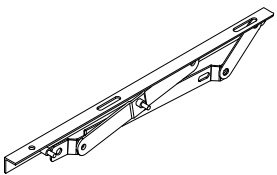
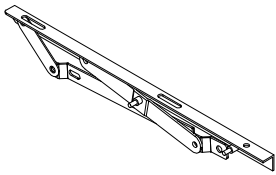
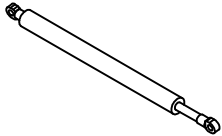
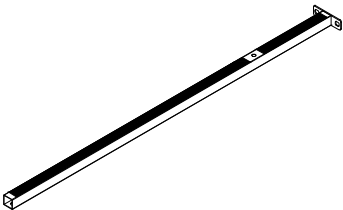
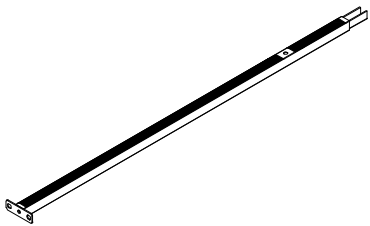
<p>A</p>  <p>Headboard-1PC</p>	<p>B</p>  <p>Footboard-1PC</p>	<p>C3</p>  <p>Headboard rail-1PC</p>	<p>G</p>  <p>Adapter-1PC</p>
<p>H</p>  <p>Pad Tube-2PCS</p>	<p>I2</p>  <p>Side tube-2PCS</p>	<p>J5</p>  <p>connect HB Front Rail-1PC</p>	<p>J6</p>  <p>connect FB Back Rail-1PC</p>
<p>K3</p>  <p>Middle Rail-1PC</p>	<p>L</p>  <p>side Supporting Leg -2PCS</p>	<p>M3</p>  <p>Slat-12PCS</p>	<p>P</p>  <p>Supporting Leg-2PCS</p>
<p>Q</p>  <p>Indices "L"-4PCS</p>	<p>R</p>  <p>Plastic caps(Single) -24PCS</p>	<p>S</p>  <p>Legs-2PCS</p>	<p>T</p>  <p>light-1PC</p>
<p>U</p>  <p>Plastic Block-5PCS</p>	<p>V</p>  <p>Block Bar-2PCS</p>	<p>W</p>  <p>Straps-1PC</p>	
<p>2 OF 20</p>			

Part list N601P375918

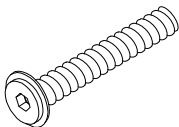
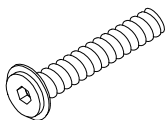
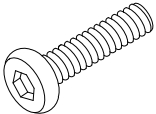
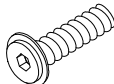
<p>D1</p>  <p>front bed side(L)-1PC</p>	<p>D2</p>  <p>front bed side(R)-1PC</p>	<p>D3</p>  <p>Rear bed side-2PCS</p>
<p>E</p>  <p>Leg Headboard-2PCS</p>	<p>H1</p>  <p>Hydraulic (L)-1PC</p>	<p>H2</p>  <p>Hydraulic (R)-1PC</p>
<p>N2</p>  <p>Hydraulic Bar-2PCS</p>	<p>03</p>  <p>front-Middle Bed Beam-1PC</p>	<p>04</p>  <p>Rear-Middle Bed Beam-1PC</p>

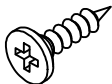
Hardware list N601P375917

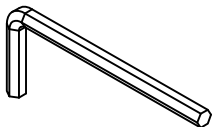
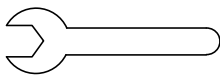
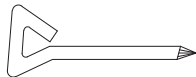

 <p>M8*50MM X1*6PCS</p>	 <p>M8*45MM X2*8PCS</p>	 <p>M8*40MM X3*10PCS</p>	 <p>M8*30MM X4*14PCS</p>	 <p>M8*16MM X5*36PCS</p>	
 <p>M8 X6*10PCS</p>	 <p>M3*15MM X7*2PCS</p>	 <p>φ22*φ8.5 Y*4PCS</p>	 <p>M5 Z1*1PC</p>	 <p>M13 Z2*1PC</p>	 <p>M5 Z3*1PC</p>
<p>3 OF 20</p>					

Detail View

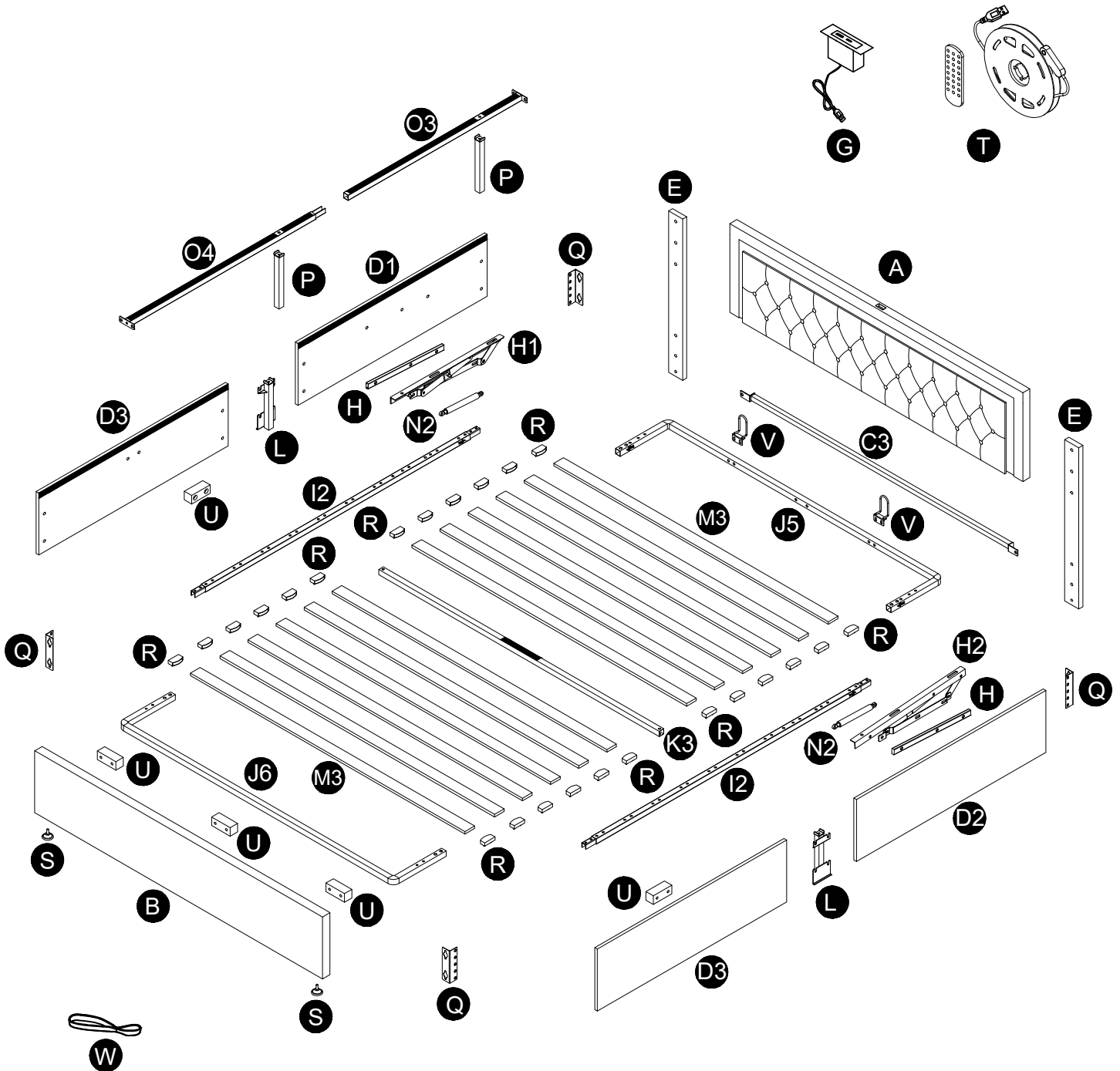
NOTE: Please do not completely tighten all the hardware until the entire assembly is complete!



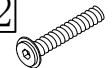

step1

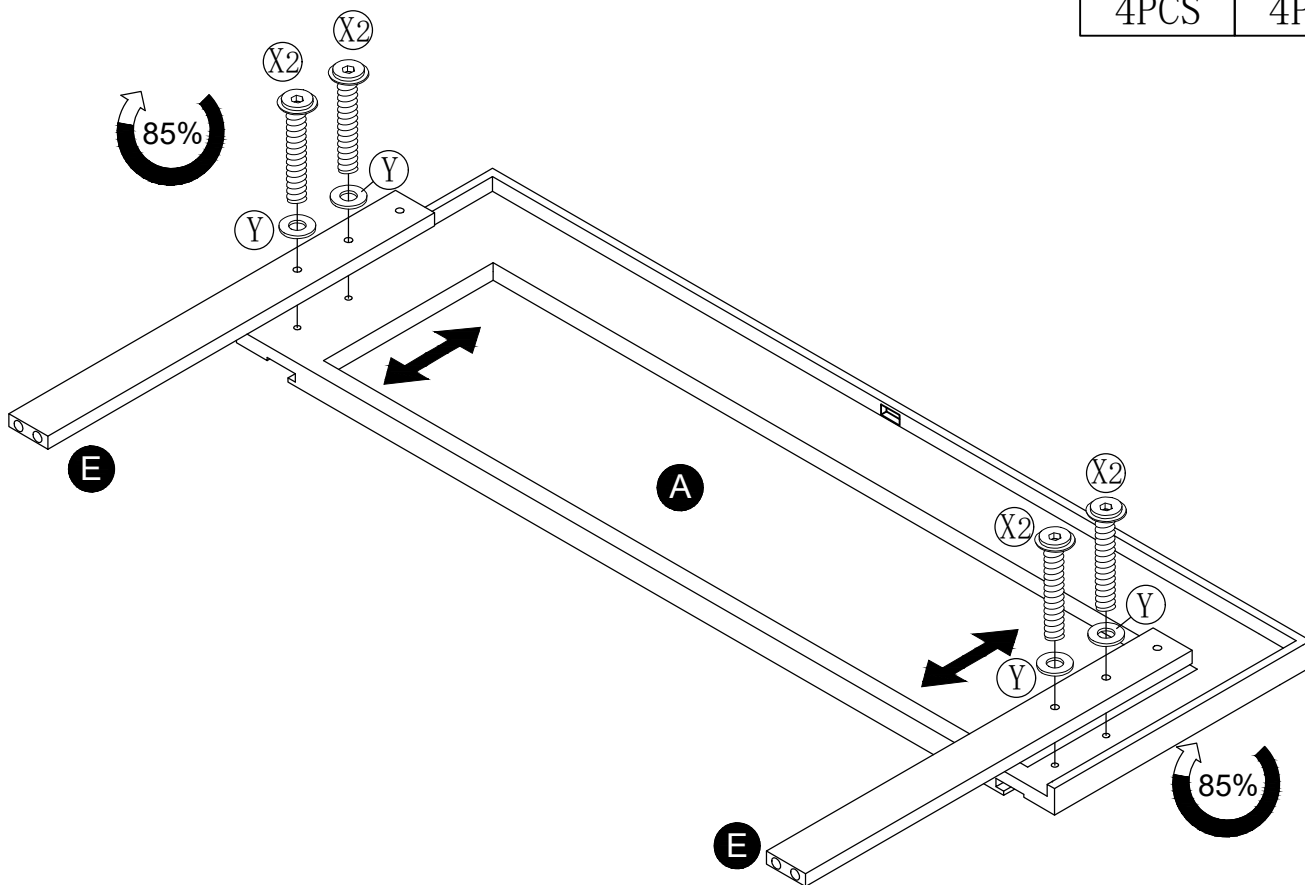
X2		Y	
	M8*45MM		φ22*φ8.5
4PCS		4PCS	



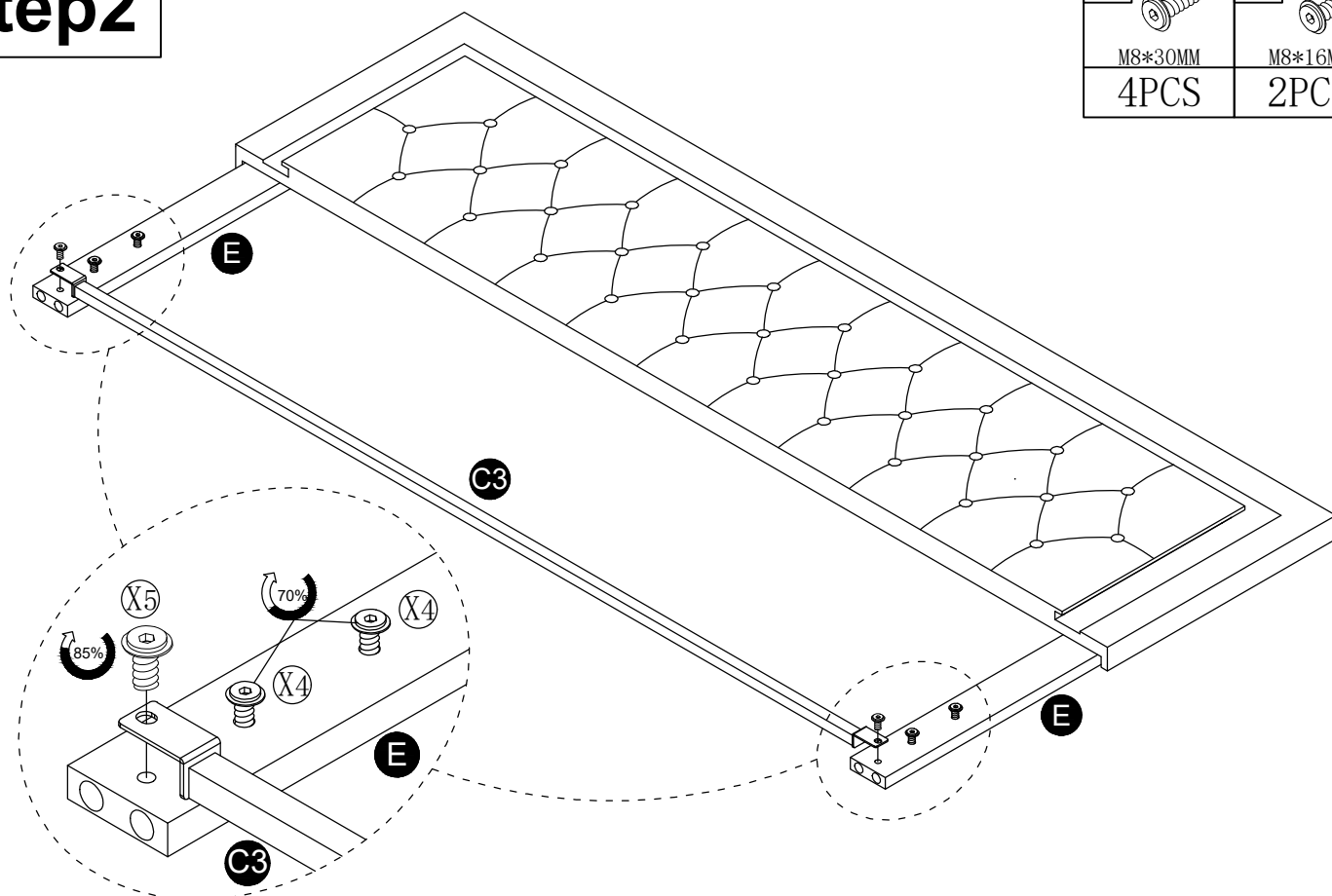

step2

X4		X5	
	M8*30MM		M8*16MM
4PCS		2PCS	



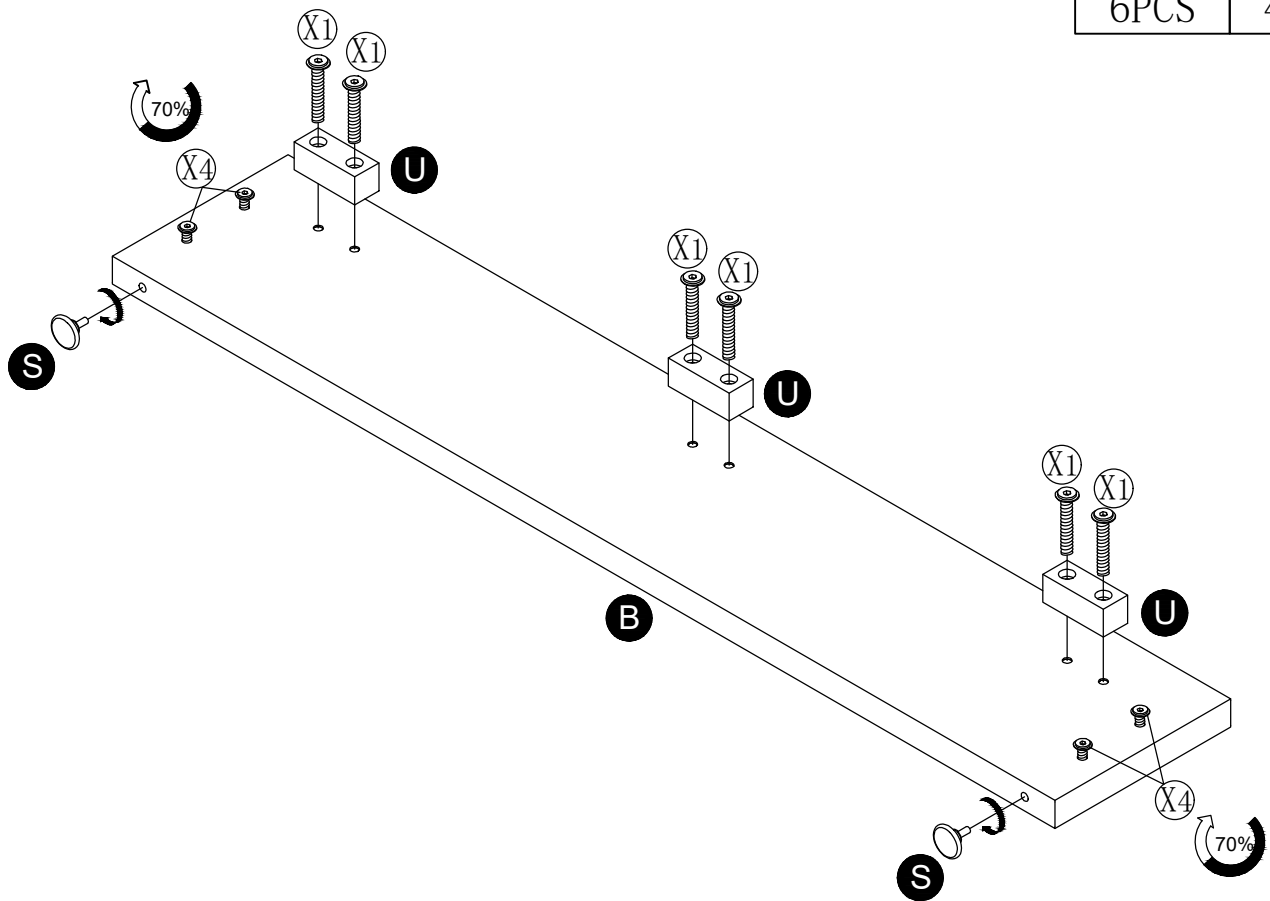

step3

X1		X4	
	M8*50MM		M8*30MM
6PCS		4PCS	



step4

X2		X5	
	M8*45MM		M8*16MM
4PCS		16PCS	

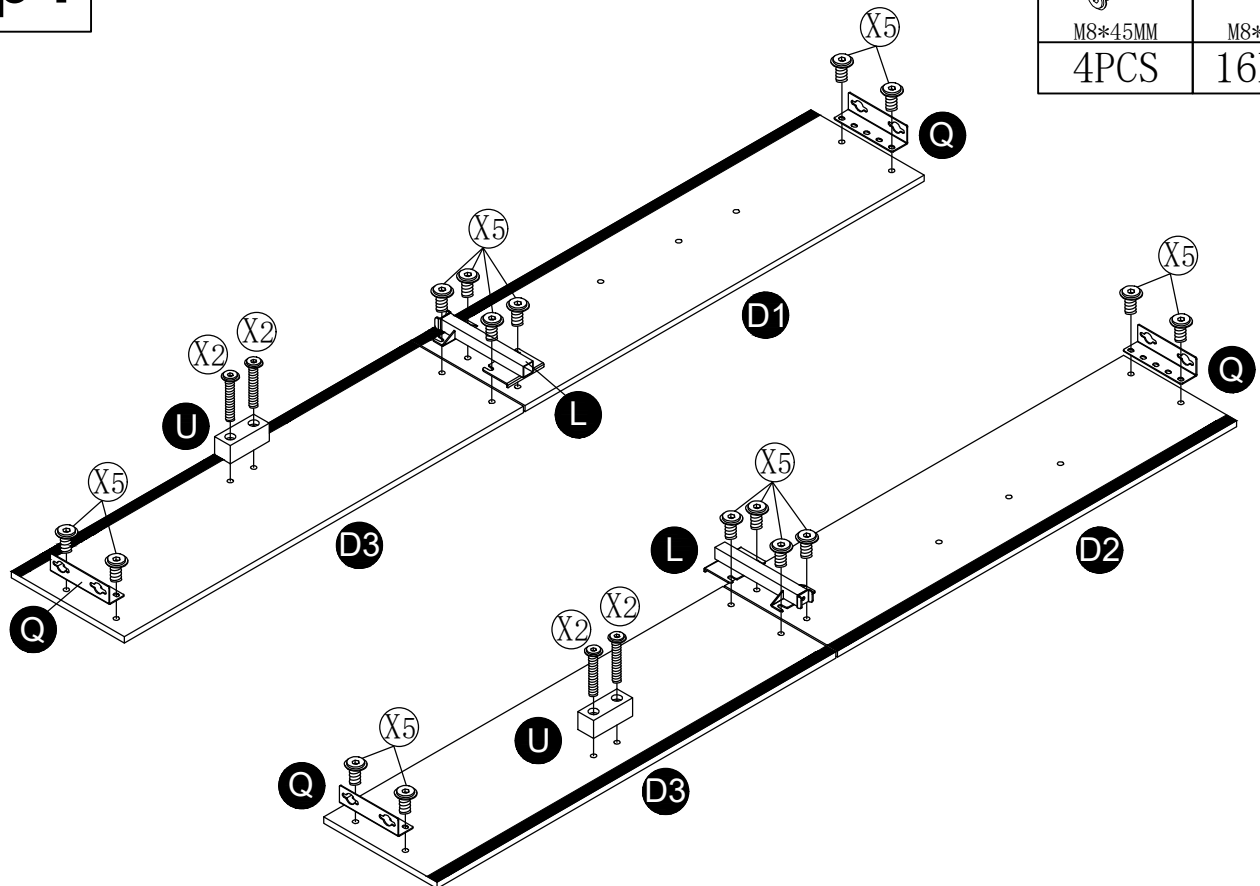

step5

X4
M8*30MM
6PCS

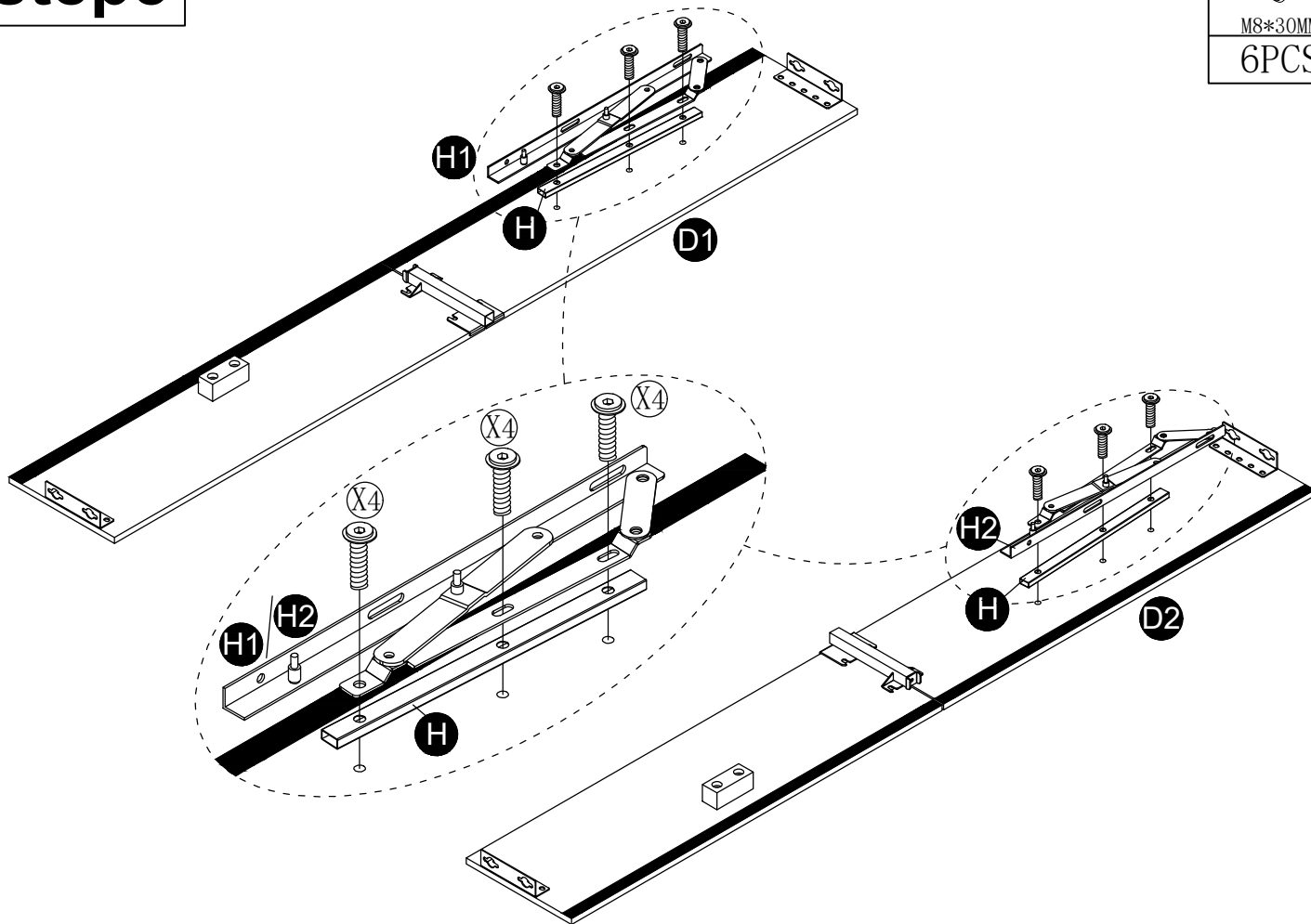

step6

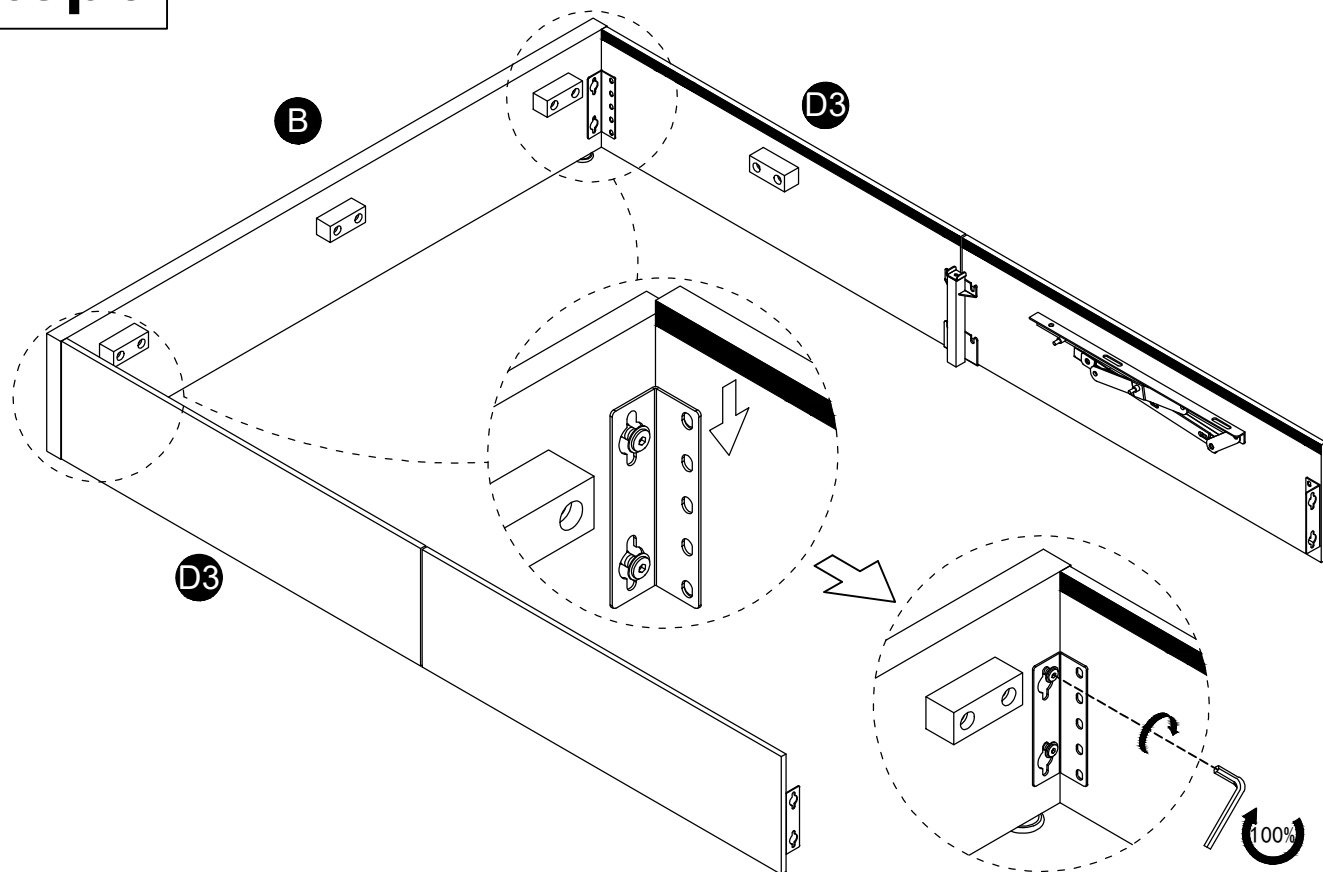

step7

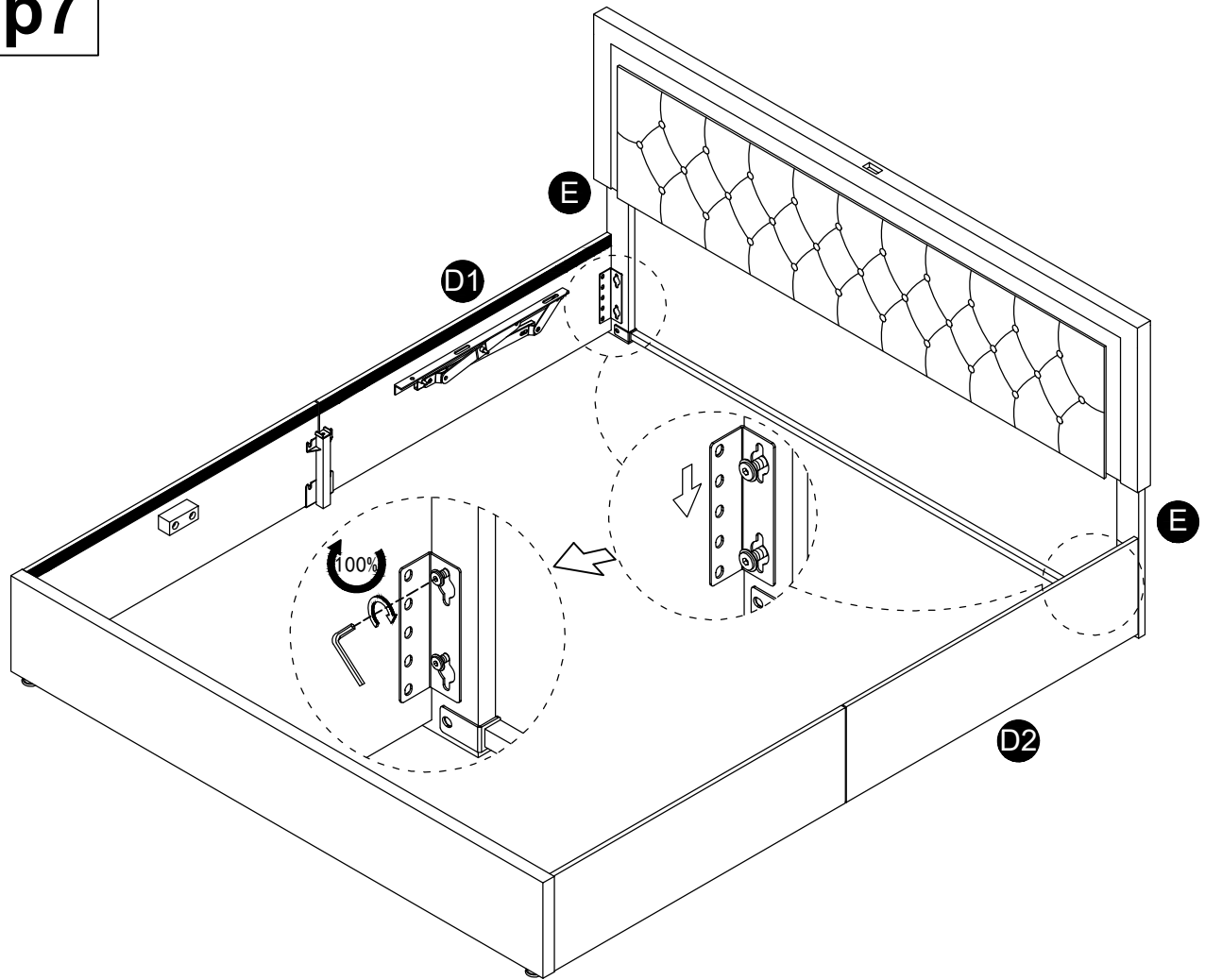

step8

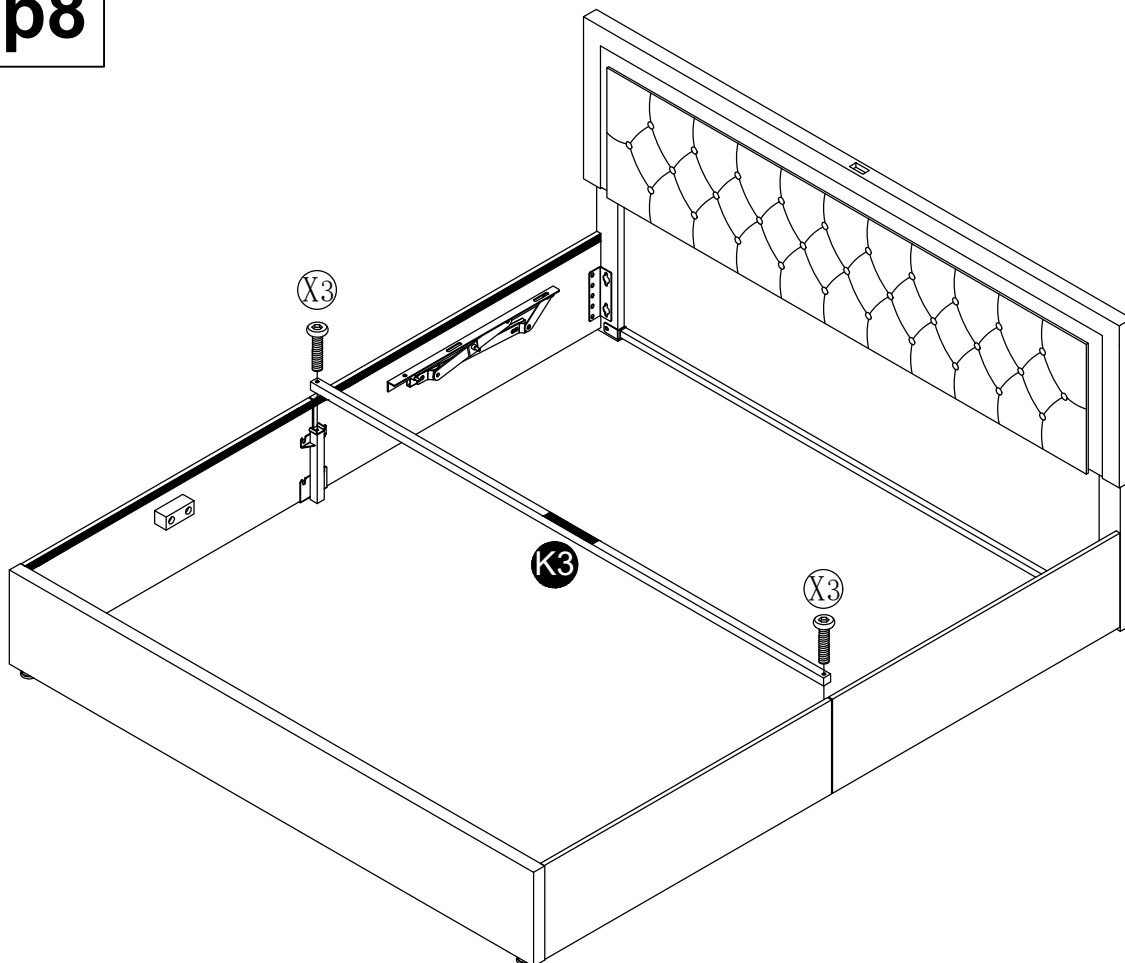

X3
M8*40MM
2PCS

step9

X5



M8*16MM

2PCS

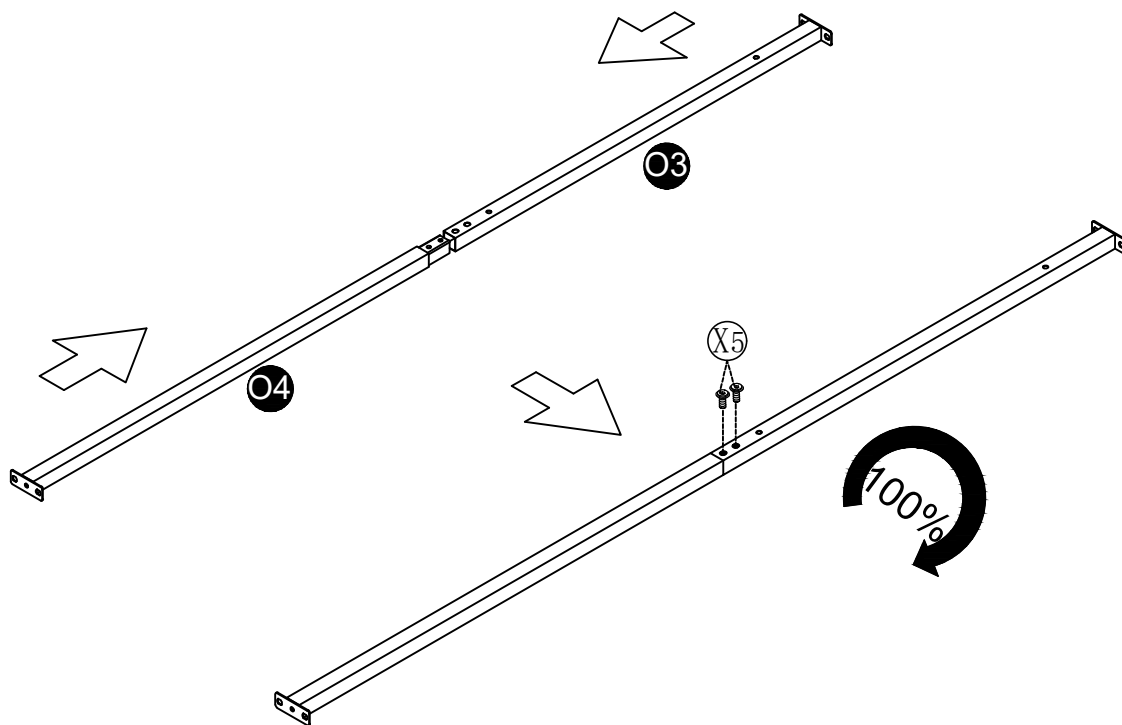

step10

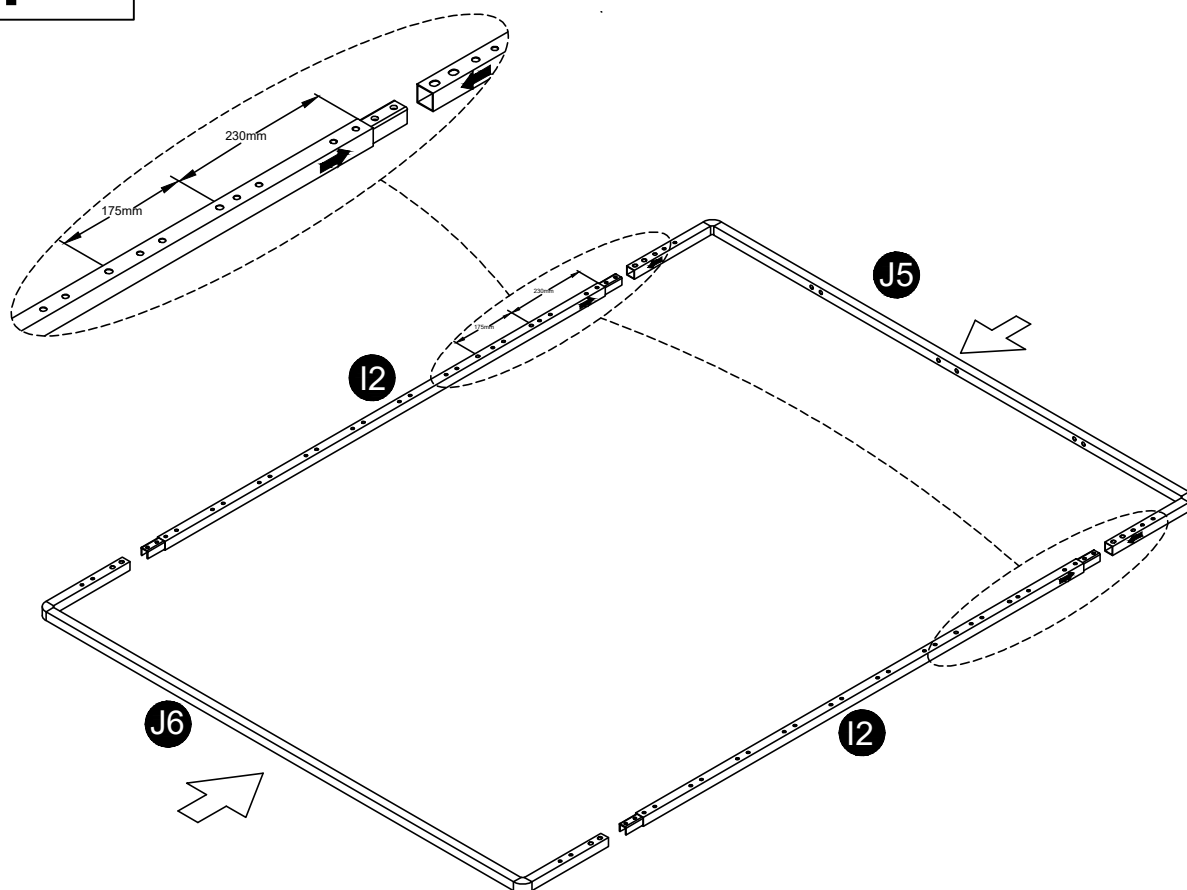

step11

X5



M8*16MM

8PCS

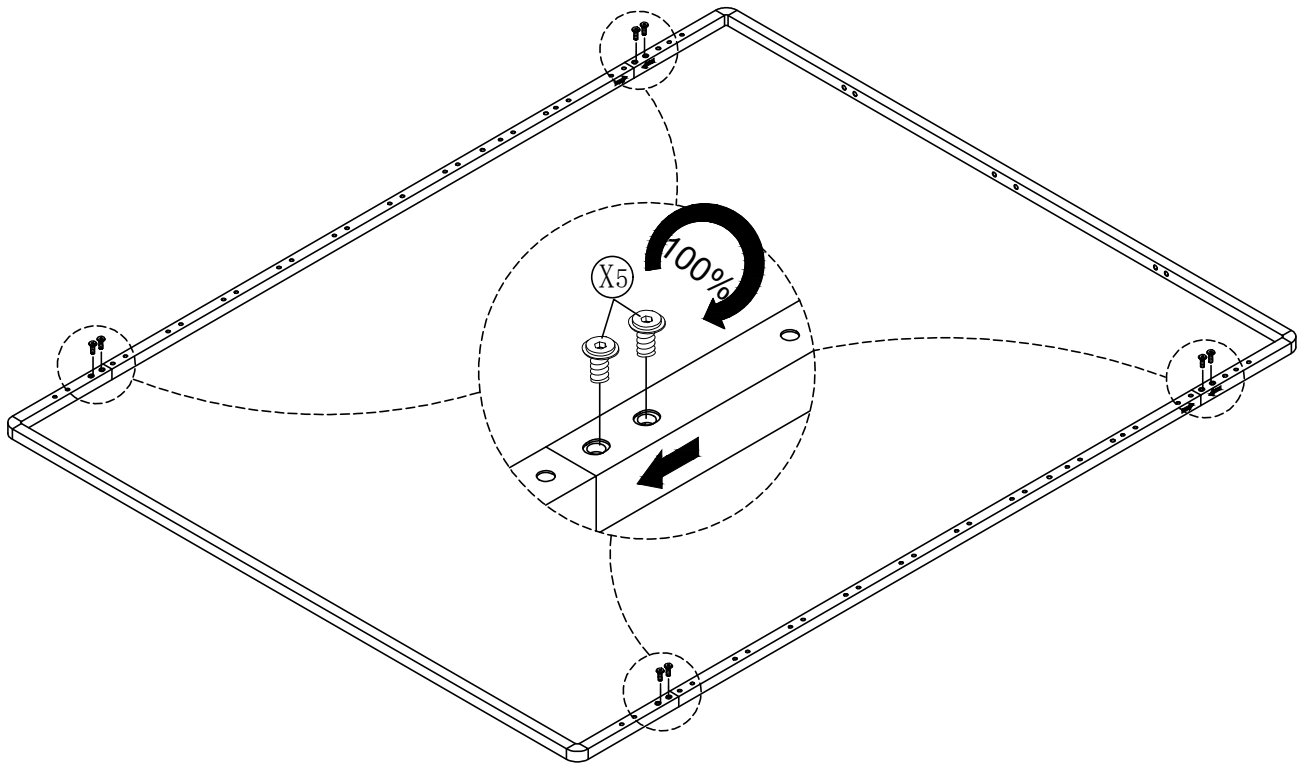

step12

X5



M8*16MM

8PCS

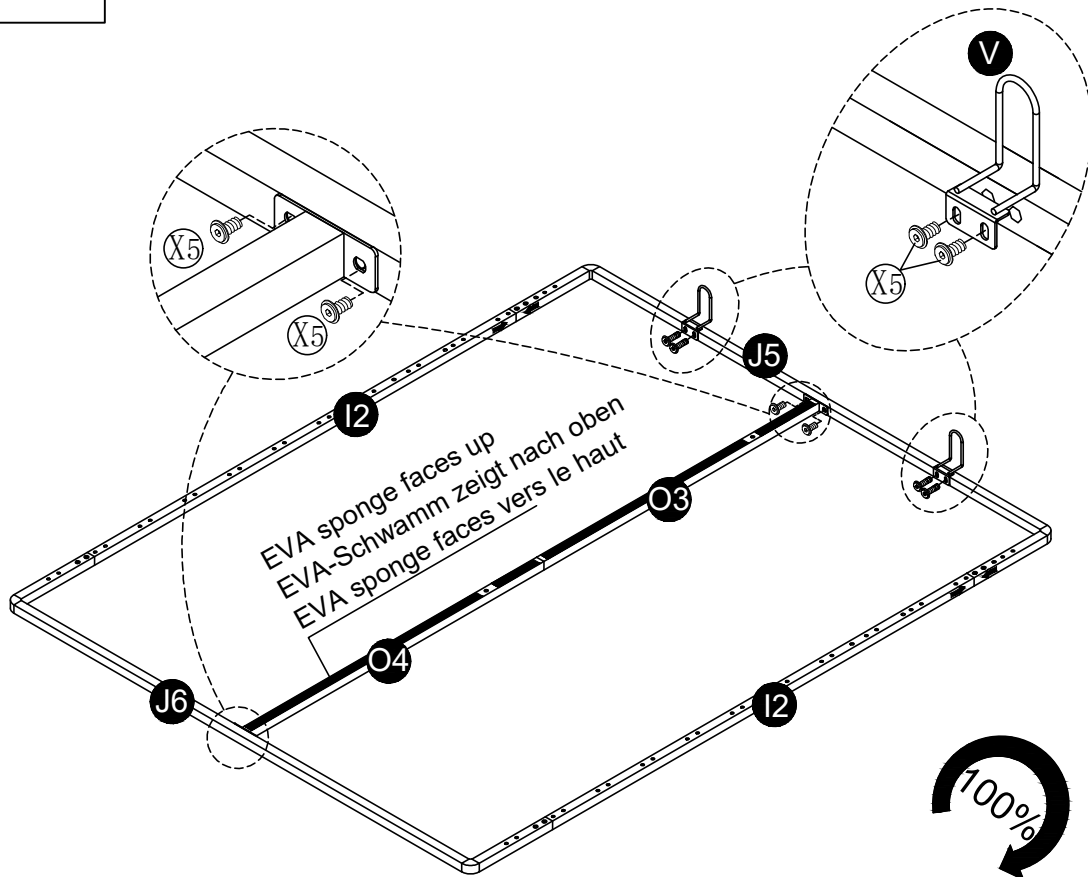

step13

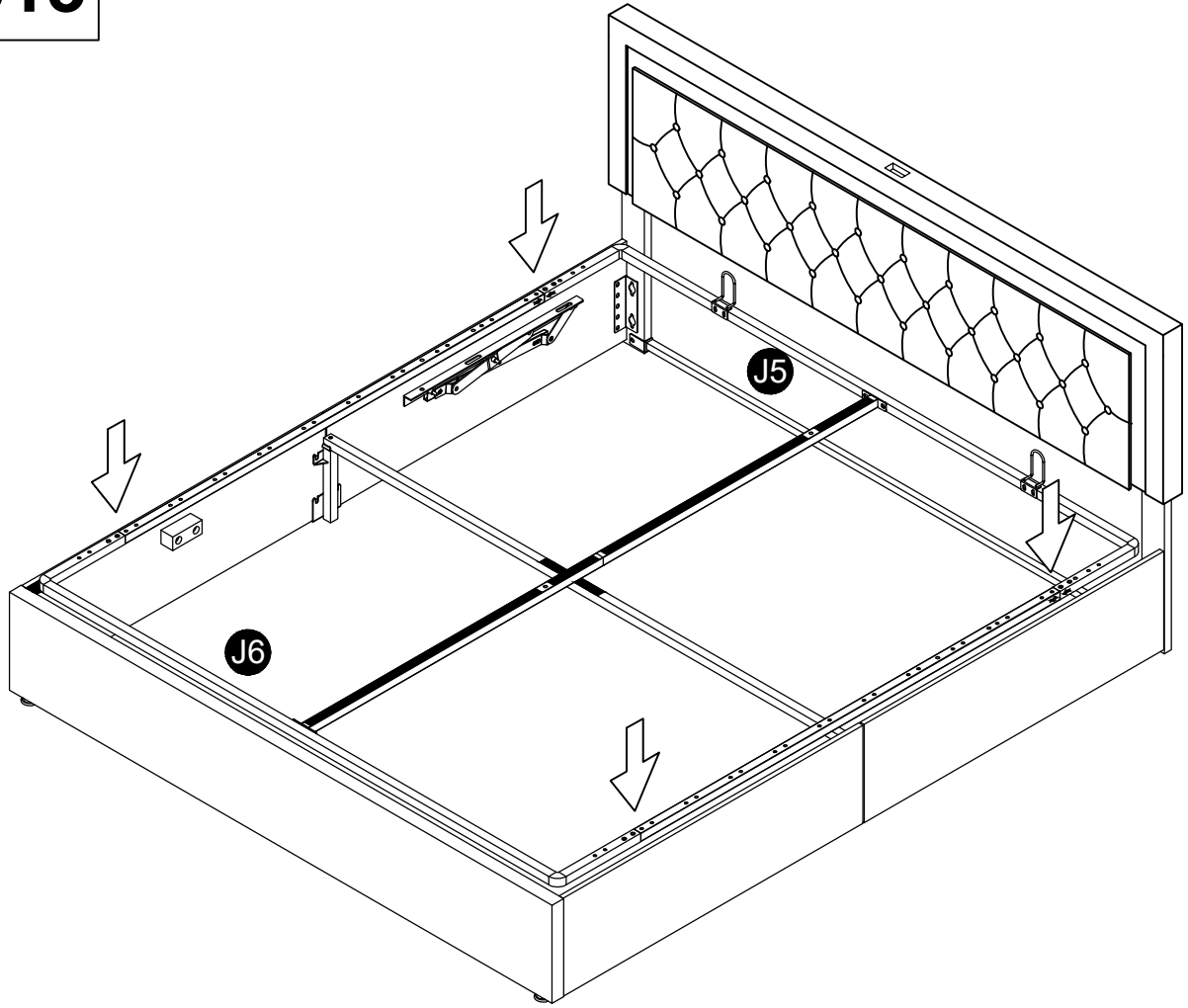

step14

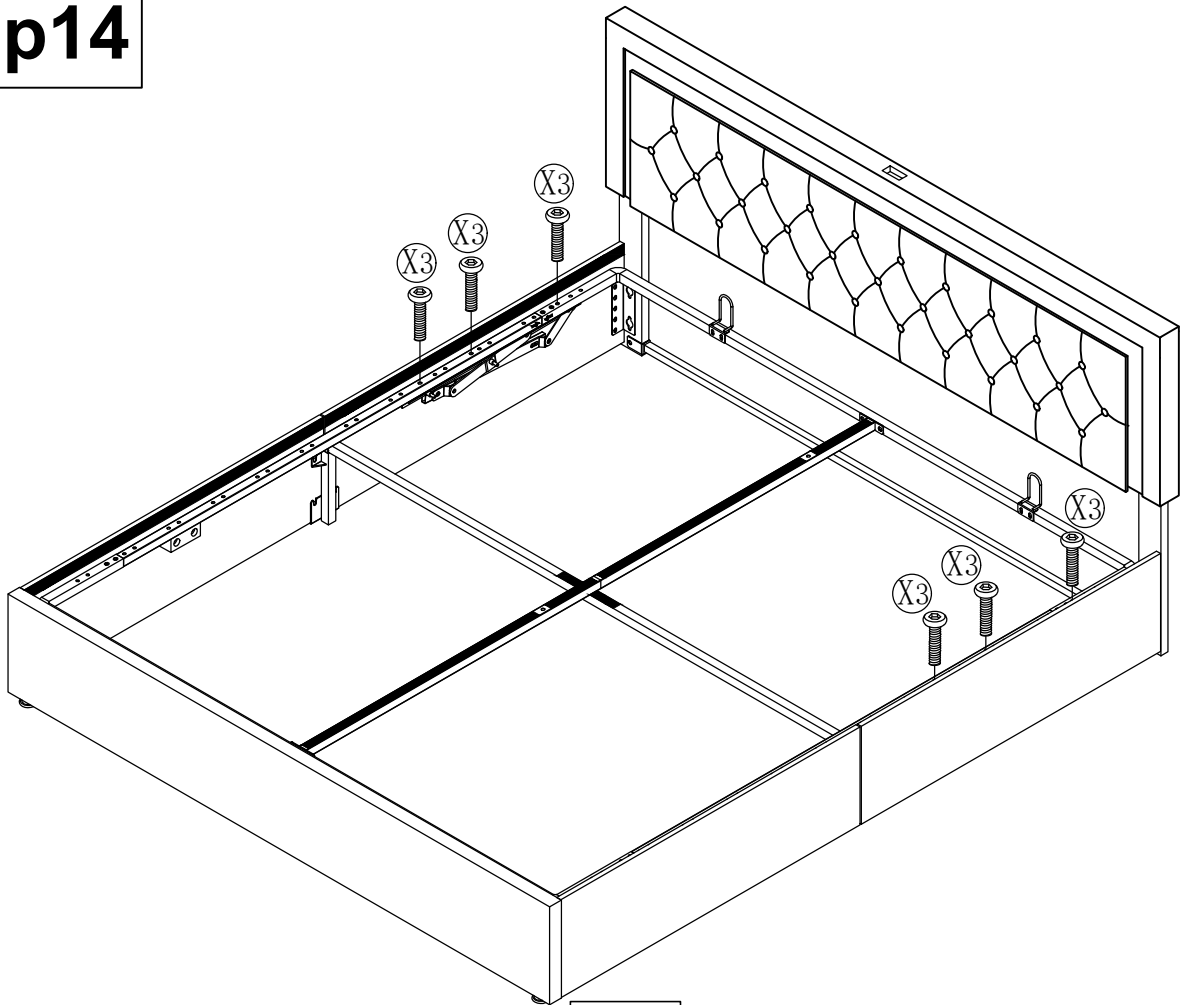

X3
M8*40MM
6PCS

step15

X6
M8
6PCS

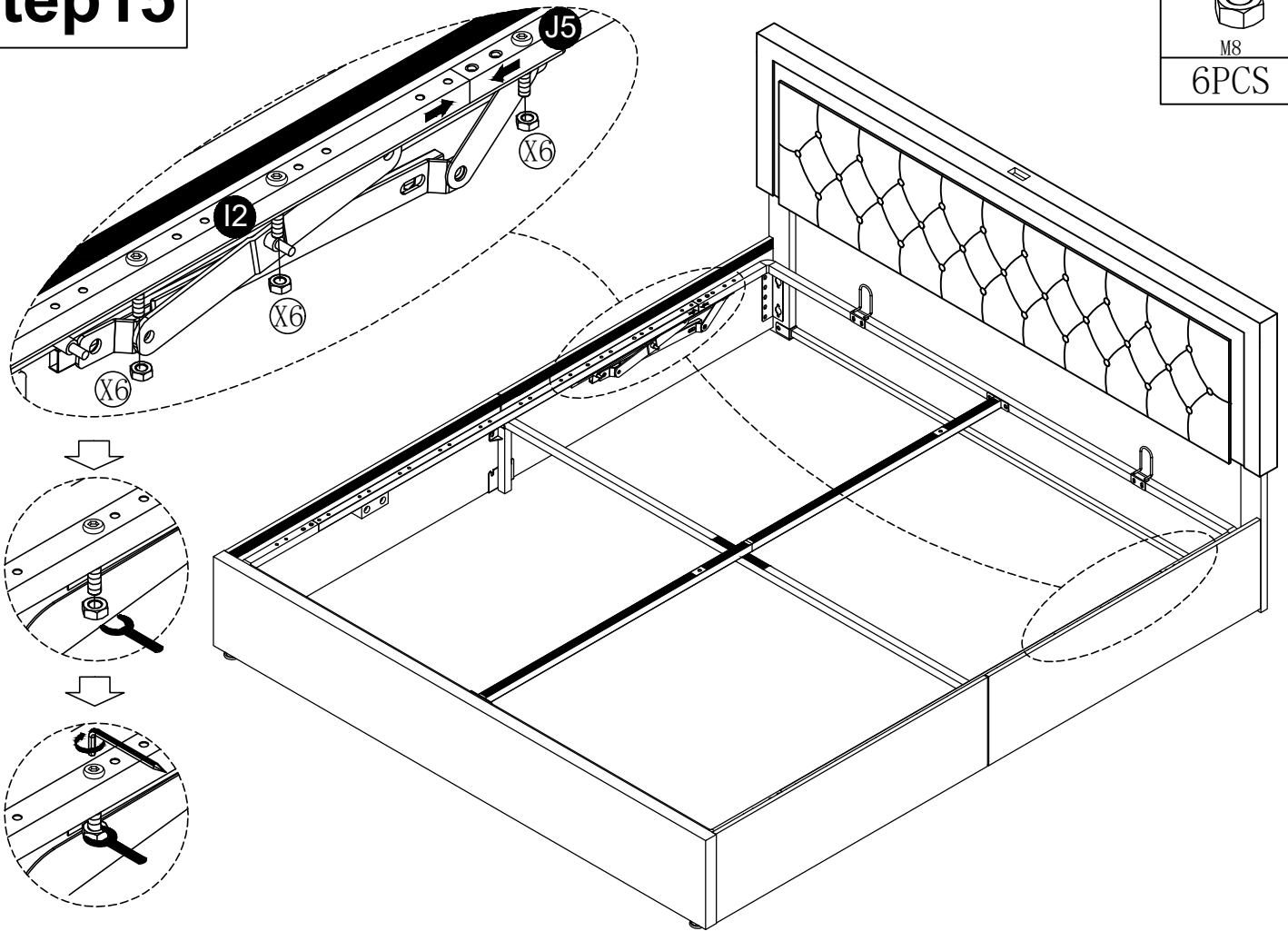

step16

X3
M8*40MM
2PCS

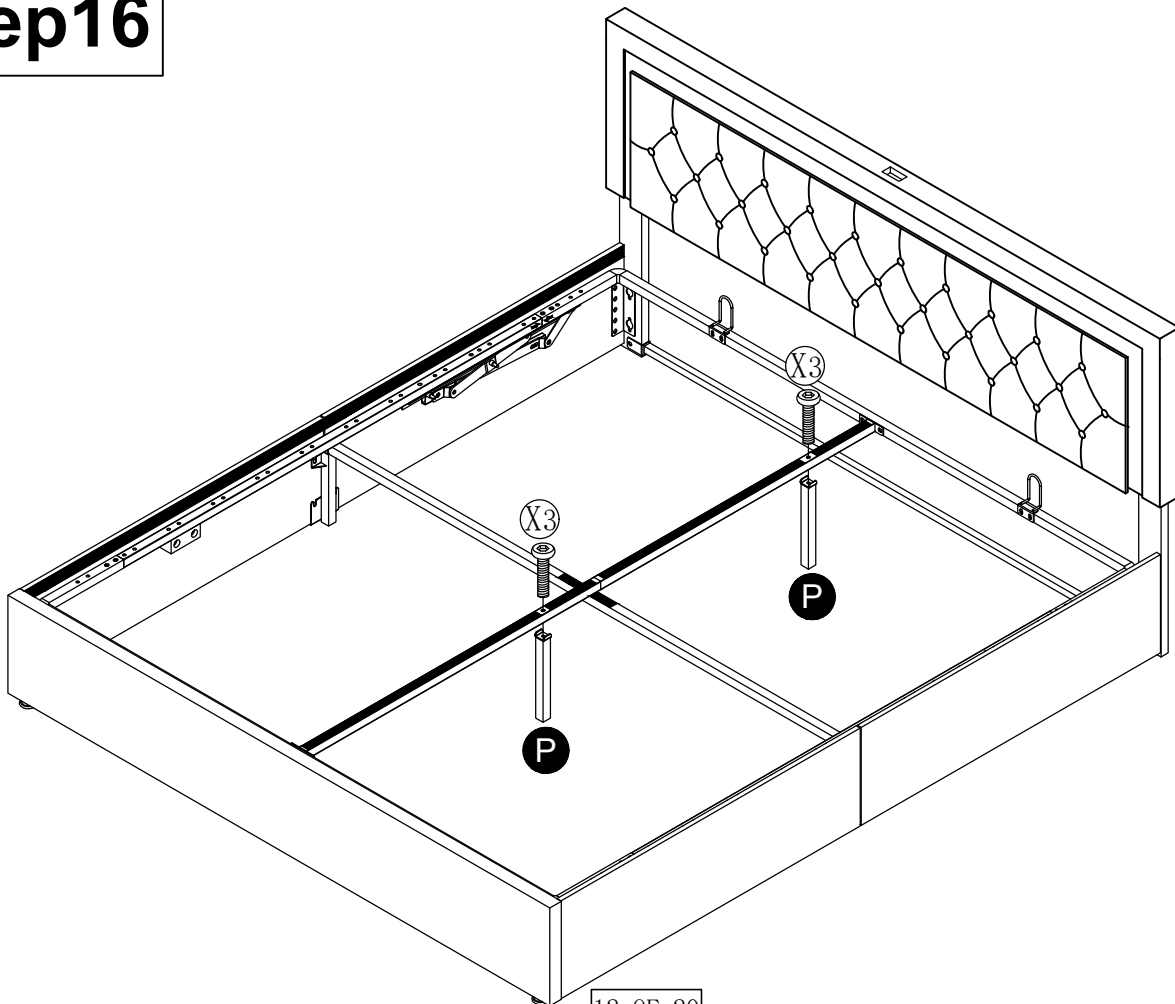

step17

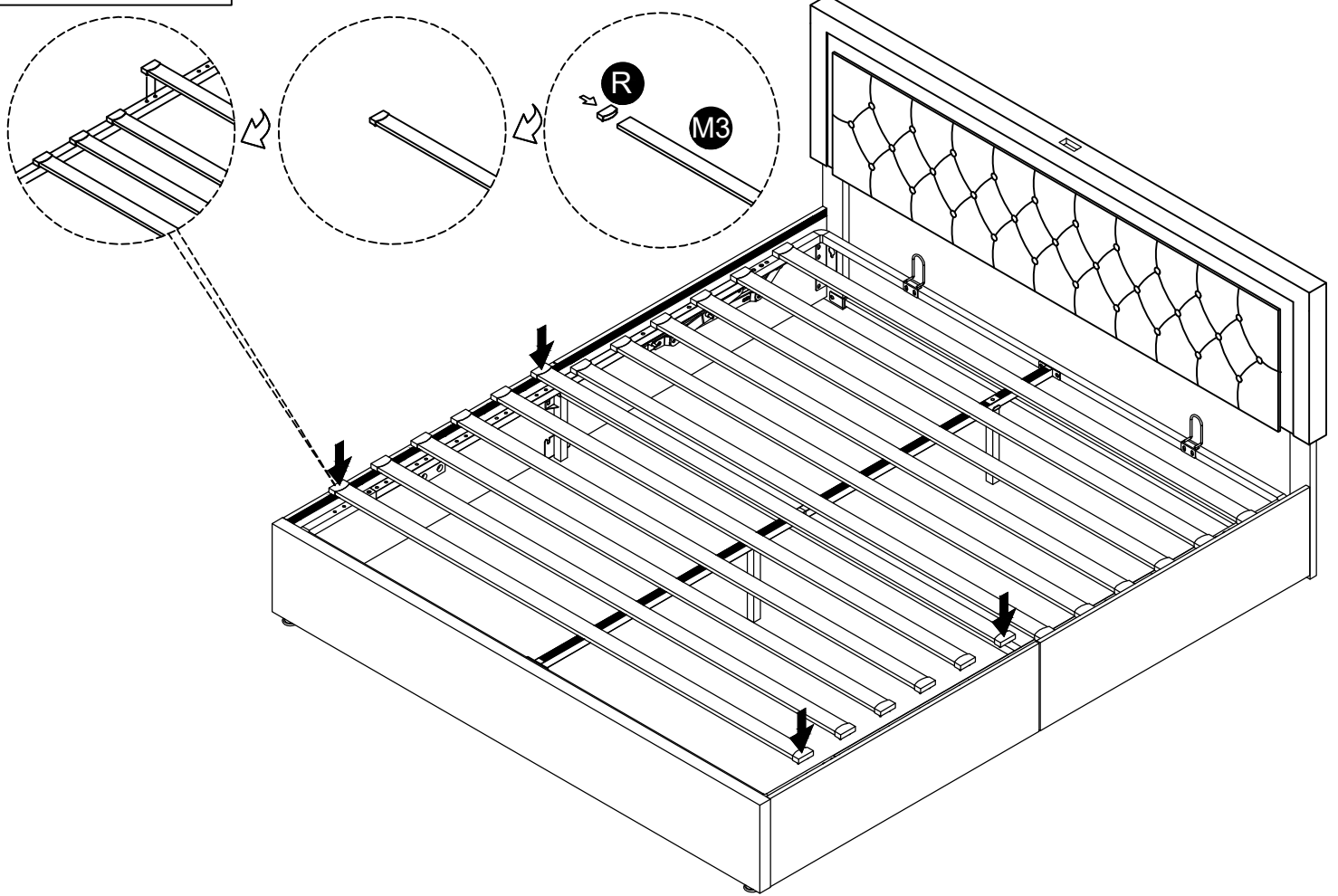

step18

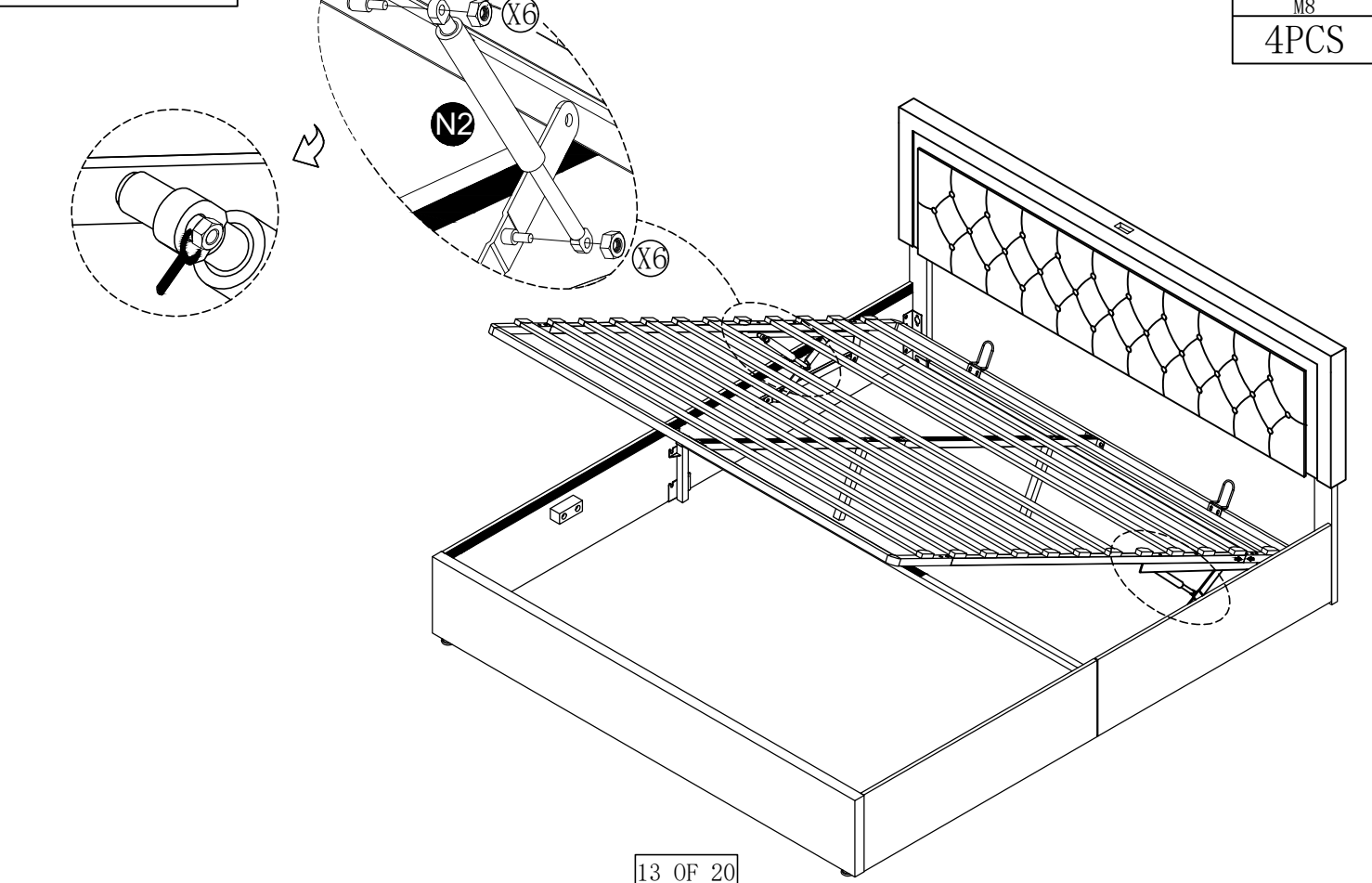

step19

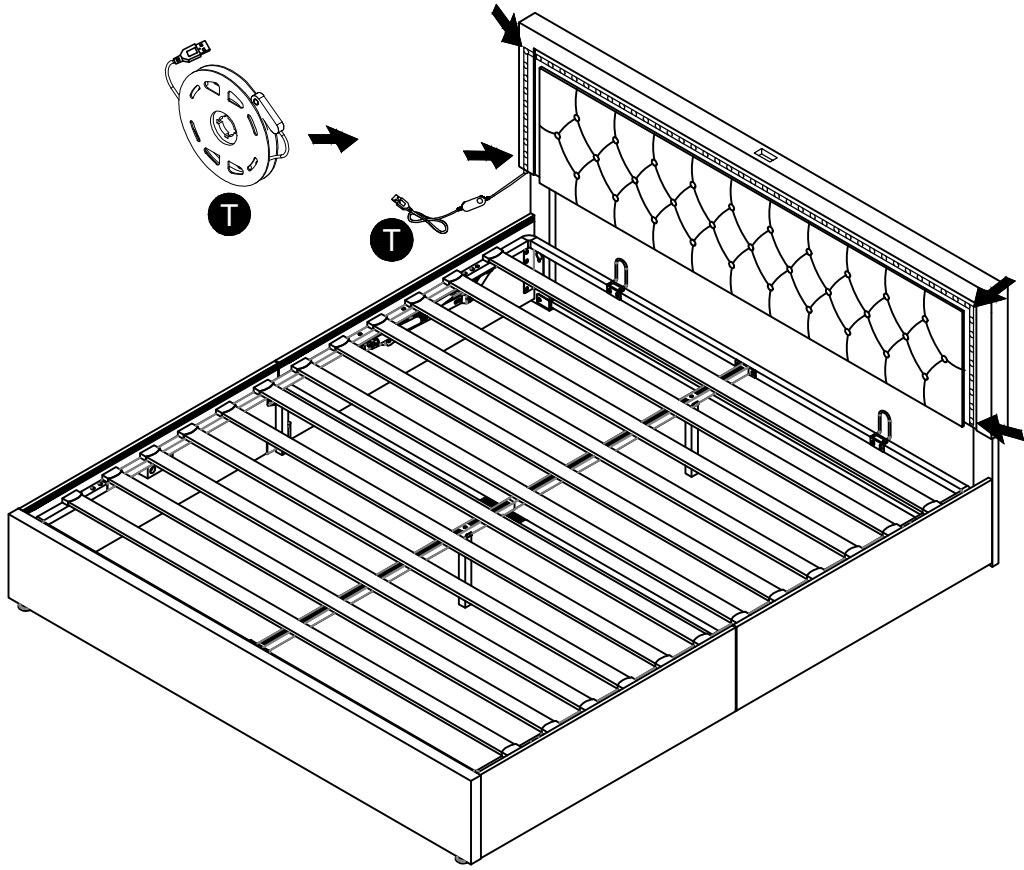

step20

X7
M3*1.5MM
2PCS

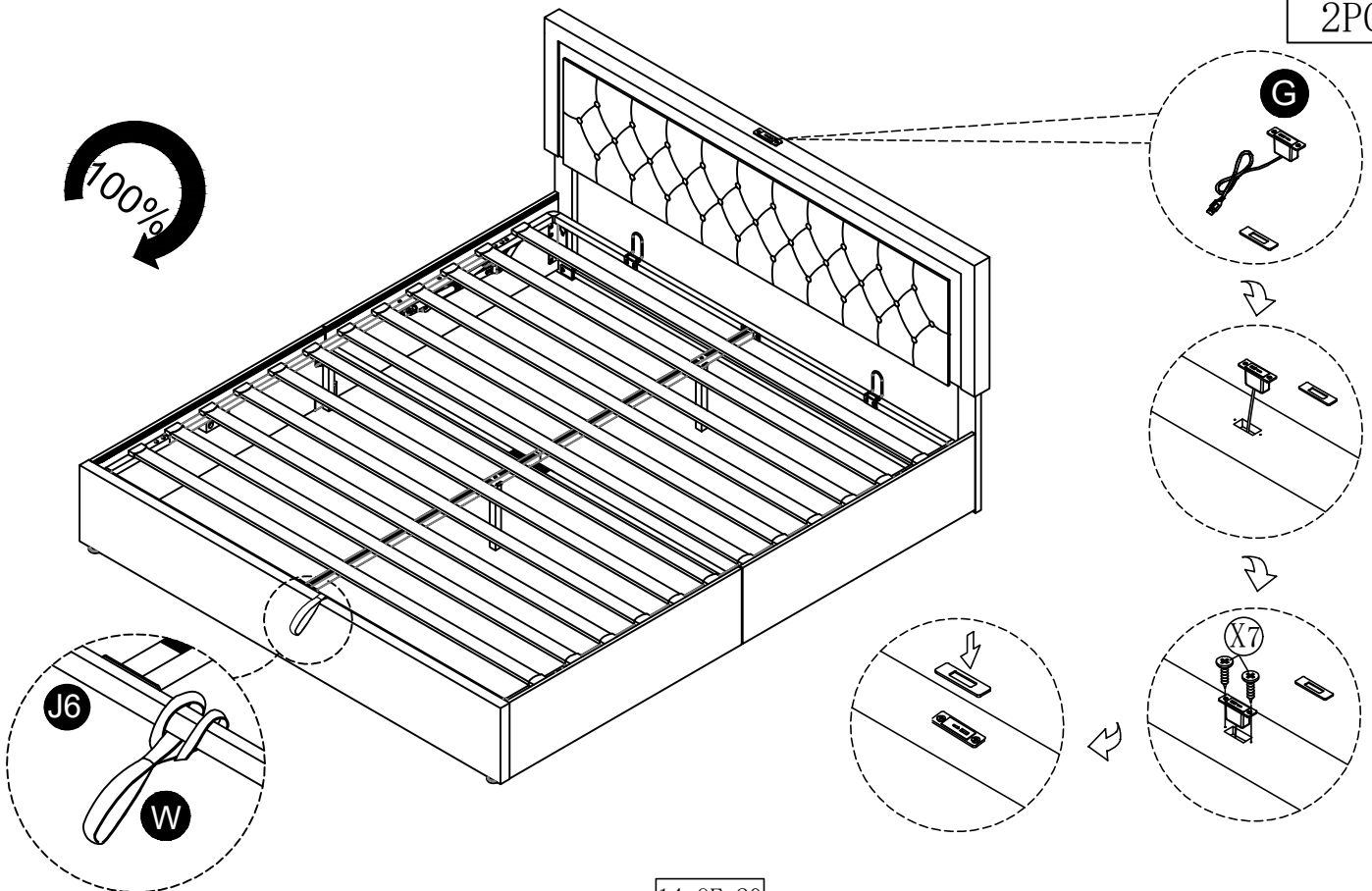

IMPORTANT NOTICE

OTTOMAN OPERATING INSTRUCTIONS

Once your bed frame is completely assembled, the slat unit will not operate correctly unless a mattress is placed on the slat frame. Position the mattress on the slat frame whilst it is in the closed position.

PLEASE NOTE It -takes a lot of force to make the initial movement of the ottoman. This is a design feature of the product so that it does not fall shut -the nearer to being closed the ottoman is, the easier it is to move. When the ottoman is almost shut, it will close completely under its own weight.

When lowering the slat unit for the first time, take care to make sure it does not rub unevenly on the inside face of the side rails. If it does, the bed has been assembled slightly out of square. This can be rectified by moving the foot end of the bed slightly to the left or right whilst leaving the head end stationary.

PISTONS

The pistons used in the construction of this product are extremely strong and cannot be operated by hand when taken off the ottoman. All pistons are tested for correct pressure and operation before being attached to the slat unit. Initially it might appear that the pistons are very stiff when opening and closing the ottoman.

THIS IS PERFECTLY NORMAL

When fully assembled and the mattress is in position, please raise and lower the ottoman 4/5 times to ensure the gas piston are fully lubricated.

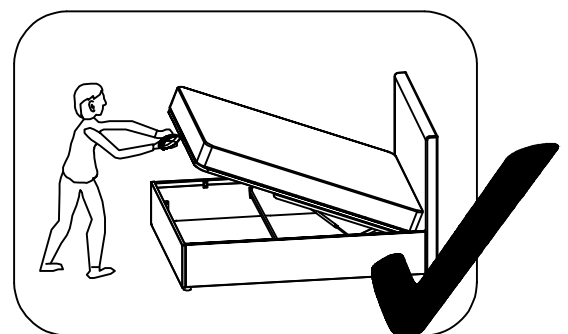
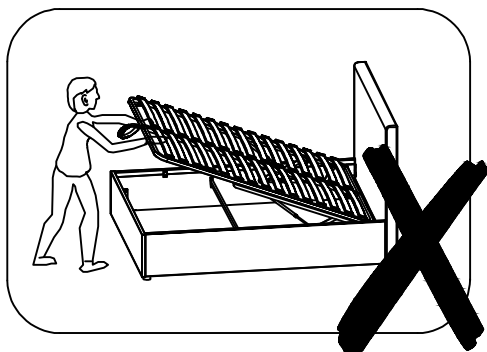

EN:Battery Safety Instructions

1. Do not dispose of used button batteries or remote controls in household trash. To protect the environment and prevent hazardous leakage, please follow these guidelines:
2. Remove button batteries after use and take them to a local battery recycling point or hazardous waste collection site.
3. Do not burn or dismantle the batteries to avoid explosion or toxic release.
4. If the remote control is no longer in use, please deliver it to a certified electronics recycling facility to promote resource reuse.
5. Keep out of reach of children to prevent accidental ingestion or injury.
6. This product does not include batteries; please purchase them separately. The compatible button cell model for the remote control is CR2025 3V.
7. If the light strip is not working, please try replacing the battery first. If the issue persists, contact the seller for assistance.
8. **Keep the remote control away from children — keep it away from children!** If the battery is accidentally swallowed, seek medical attention immediately.

DE:Batteriesicherheitshinweise

1. Entsorgen Sie gebrauchte Knopfzellen oder Fernbedienungen nicht im Hausmüll. Um die Umwelt zu schützen und gefährliche Leckagen zu vermeiden, beachten Sie bitte die folgenden Hinweise:
2. Entfernen Sie die Knopfzelle nach dem Gebrauch und bringen Sie sie zu einer örtlichen Batteriesammelstelle oder einem Sondermüllentsorgungszentrum.
3. Batterien nicht verbrennen oder zerlegen, um Explosionen oder die Freisetzung giftiger Stoffe zu vermeiden.
4. Wenn die Fernbedienung nicht mehr verwendet wird, bringen Sie sie zu einer zertifizierten Elektronik-Recyclingstelle, um eine Wiederverwertung zu ermöglichen.
5. Außerhalb der Reichweite von Kindern aufbewahren, um versehentliches Verschlucken oder Verletzungen zu verhindern.
6. Dieses Produkt enthält keine Batterien. Bitte kaufen Sie diese separat. Das kompatible Knopfzellenmodell für die Fernbedienung ist CR2025, 3V.
7. Wenn der Lichtstreifen nicht funktioniert, versuchen Sie zunächst, die Batterie zu wechseln. Besteht das Problem weiterhin, kontaktieren Sie bitte den Verkäufer.
8. **Halten Sie die Fernbedienung unbedingt von Kindern fern — unbedingt fernhalten!** Wird die Batterie versehentlich verschluckt, suchen Sie sofort medizinische Hilfe auf.

FR:Instructions de sécurité pour les piles

1. Ne jetez pas les piles bouton usagées ou les télécommandes à la poubelle ménagère. Pour protéger l' environnement et éviter tout risque de fuite dangereuse, veuillez suivre les consignes suivantes :
2. Retirez les piles bouton après usage et déposez-les dans un point de collecte local ou un centre de déchets dangereux.
3. Ne brûlez pas et ne démontez pas les piles, cela pourrait entraîner une explosion ou libérer des substances toxiques.
4. Si la télécommande n'est plus utilisée, déposez-la dans un centre de recyclage agréé pour appareils électroniques, afin de favoriser la réutilisation des ressources.
5. Gardez hors de portée des enfants pour éviter tout risque d'ingestion accidentelle ou de blessure.
6. Ce produit ne contient pas de pile. Veuillez l'acheter séparément. Le modèle de pile bouton compatible pour la télécommande est CR2025, 3V.
7. Si le ruban LED ne fonctionne pas, essayez d'abord de remplacer la pile. Si le problème persiste, contactez le vendeur.
8. **Tenez la télécommande éloignée des enfants — éloignez-la vraiment !** En cas d'ingestion accidentelle de la pile, consultez immédiatement un médecin.

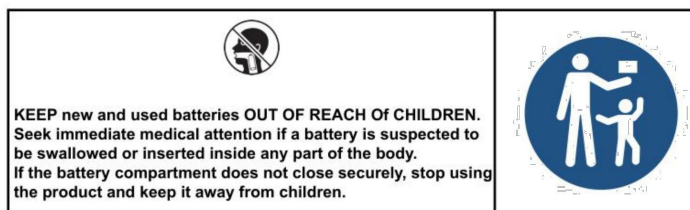

If a battery has been ingested, or there is a possibility one might have been ingested, please seek medical attention and inform the medical authorities that you suspect battery ingestion.

It's not always clear when a child has swallowed a button battery, as there are no specific symptoms. However, they might:

- cough, gag, or drool;
- seem to have a stomach bug or virus;
- vomit;
- complain of pain in their stomach, chest, or throat;
- appear tired or sluggish; and
- lose their appetite.

Since the signs aren't obvious, it's important to keep a close eye on loose, used, or spare button batteries in your home, as well as the products that contain them.

1



2



3



4



5



6



7



8





Certificate No.: CBT250725069EC

Certificate of Conformity

Applicant : DONGGUAN BAIYOU ELECTRONIC CO LTD
2F A Building, Wufeng Industrial, Jintan Road, Danwu Shijie Town,
Dongguan, Guangdong

Manufacturer : DONGGUAN BAIYOU ELECTRONIC CO LTD
2F A Building, Wufeng Industrial, Jintan Road, Danwu Shijie Town,
Dongguan, Guangdong

Product : Cable

Model(s) : TD02K-1A1C

Trademark : N/A

Test Standard : BS EN 55032:2015+A11:2020+A1:2020
BS EN 55035:2017+A11:2020

Based on the voluntary assessment of the product sample and the UK Electrical Equipment (EMC) Regulations 2016(SI 2016/1091) with the above standards, we confirm that the above-mentioned product meets the requirements of the EC directive.

The UKCA mark as show below can be used, under the responsibility of the manufacturer or the importer, after completion of an EC declaration of conformity and compliance with all relevant EC directives. It is only valid in connection with the test report number: CBT250725069ER.



Shenzhen CABLETEK Compliance Laboratory Limited
East 02, 6th Floor, Building 3, Zhouteng Industrial Zone, Shanglilang
Community, Nanwan Street, Longgang District, Shenzhen

Tel: 400 666 1146

E-mail: cbt@cabletek.cn

Web: www.cabletek.cn

Shenzhen ZKT Technology Co., Ltd.
 1/F, No. 101, Building B, No. 6, Tangwei Community Industrial Avenue,
 Fuhai Street, Bao'an District, Shenzhen, China



Certificate of Compliance

Certificate Number: ZKT-2405094943C

Certificate's Holder : Shenzhen Pinchengxin Technology Co., Ltd
 3rd Floor, 8th Building Yuanling Industrial Zone, No. 39
 Yuanlingcun Road, Shiyan Street, Bao'an District,
 Shenzhen

Manufacturer : Shenzhen Pinchengxin Technology Co., Ltd
 3rd Floor, 8th Building Yuanling Industrial Zone, No. 39
 Yuanlingcun Road, Shiyan Street, Bao'an District,
 Shenzhen

Trade Mark : N/A

Product : 5050 RGB LED Strip Lights with Bluetooth App Controller
 and 2.4G Remote

Model(s) : 5050 RGB LED Strip Lights

Test Standard : Art.3.1(a) Safety BS EN IEC 62368-1:2020+A11:2020

Art.3.1(a) Health BS EN IEC 62311:2020
 BS EN 50665:2017

Art.3.1(b) EMC ETSI EN 301 489-1 V2.2.3 (2019-11)
 ETSI EN 301 489-17 V3.2.4 (2020-09)

Art.3.2 Radio ETSI EN 300 328 V2.2.2 (2019-07)

This Attestation of Compliance is issued on a voluntary basis for electrical equipment below the voltage limits of Radio Equipment Directive (RED) SI 2017 No.1206. The essential requirements are fulfilled accordingly based on the technical specifications applicable at the time of issuance.



This Certificate of Conformity is based on single evaluation of the submitted sample(s) of the above mentioned product. It does not imply an assessment of the whole product and relevant Directives to be observed.

☎ +86-400 000 9970 📠 +86-755-22336688 ✉ zkt@zkt-lab.com 🌐 www.zkt-lab.com