

Assembly Instruction

ASSEMBLY TIPS:

1. Remove hardware from box and sort by size.
2. Please check to see that all hardware and parts are present prior to start of assembly.
3. Please follow attached instructions in the same sequence as numbered to assure fast & easy assembly.



Warning!

1. Don't attempt to repair or modify parts that are broken or defective. Please contact the store immediately.
2. This product is for home use only and not intended for commercial establishment.

ASSEMBLY TIME PER UNIT : 30 MINUTES

PARTS IDENTIFICATION FOR VANITY :

A. RIGHT SUPPORT BAR 1 PC

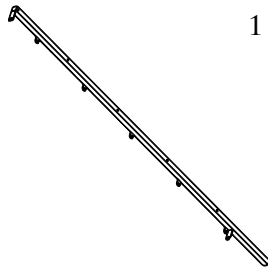

B. LEFT SUPPORT BAR 1 PC

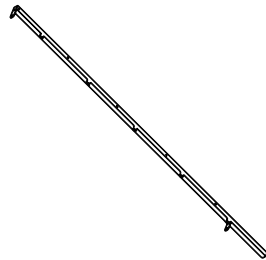

C. CROSS BAR 5 PC

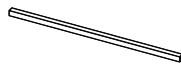

D. RIGHT FRAME 1 PC

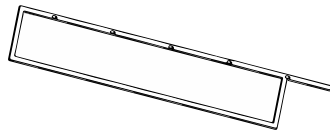



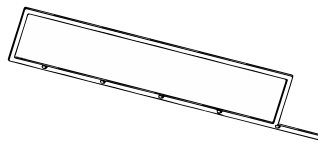

E. LEFT FRAME 1 PC

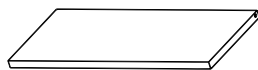

F. SHELF 5 PCS



HARDWARE PACKAGE:

Z	DESCRIPTION	FIGURE	QTY
1	ALLEN BOLT-LARGE		14 PCS
2	ALLEN BOLT-SMALL		10 PCS
3	WASHER		10 PCS
4	PLUG		4 PCS
5	ALLEN WRENCH		1 PC

STEP 1

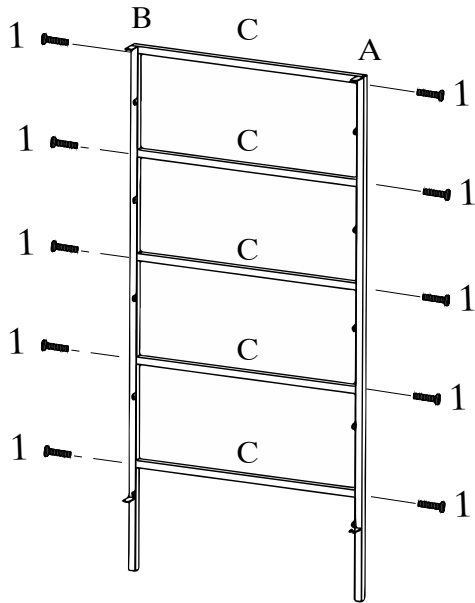

STEP 2

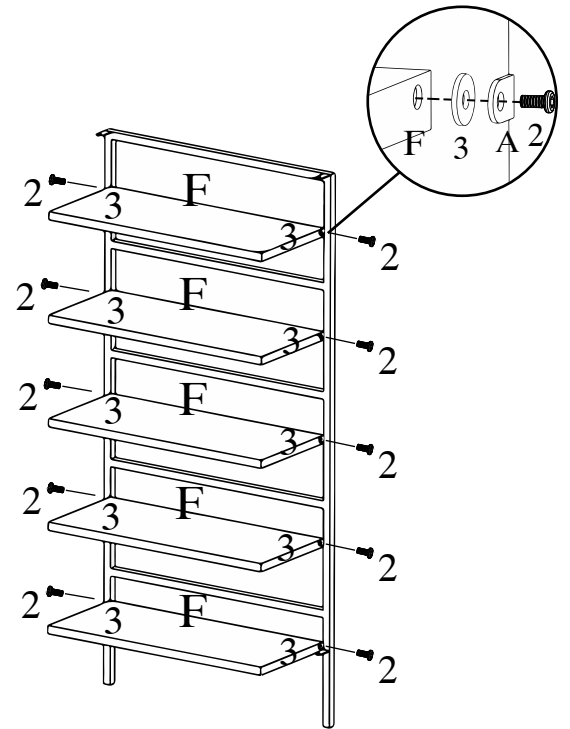

STEP 3

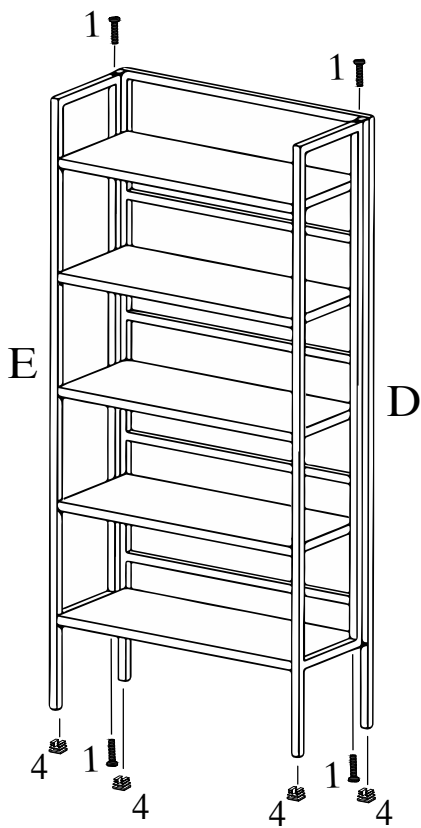

FINISH FIGURE

