

INSTALLATION

Product Manual

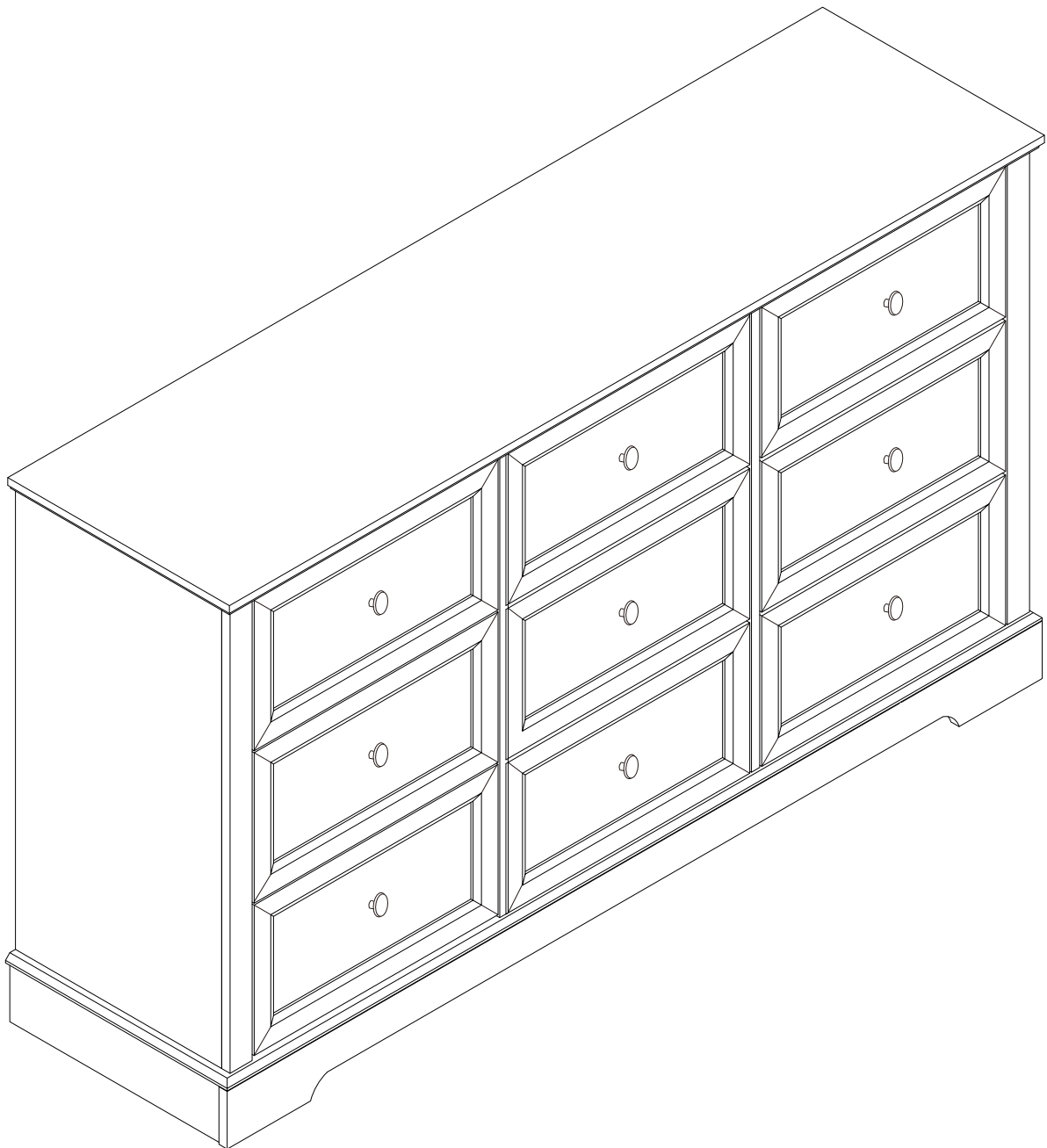

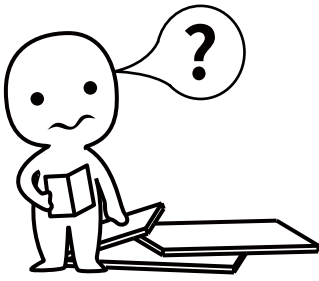

IMPORTANT INFORMATION!

please read the entire manual before starting to assemble and/or using this product. follow the manual thoroughly and keep it for further reference.

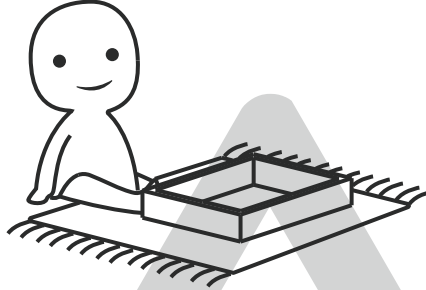
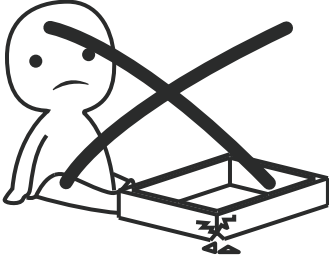

AVOID SCRATCHES!

In order to avoid scratching this furniture should be assembled on a soft layer- could be a rug.

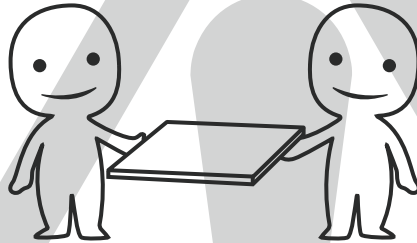

IMPROVE EFFICIENCY !

Try to find a partner to install with you, which can speed up the installation efficiency and shorten the time.

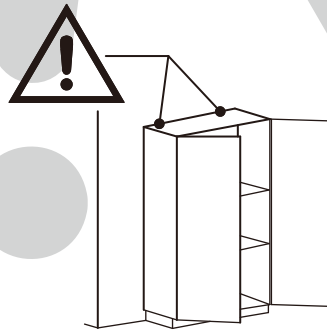
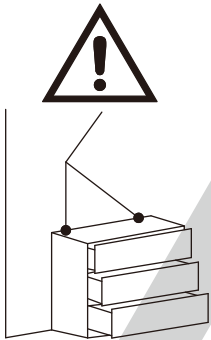

ANTI-TOPPLE WARNING !











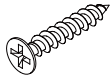

Overturned furniture can cause serious or fatal crush injuries. To prevent tipping over, be sure to use the wall attachment, if not included with this product. Please purchase the wall attachment that fit your wall. If unsure, seek professional advice. Please read and follow each step of the instructions carefully.

IMPORTANT !

It is important that any product which is assembled using any kind of screw is re-tightened 2 weeks after assembly, and once every 3 months - in order to assure stability through-out the lifespan of the product.

For regular maintenance and cleaning of the product, for the frame, please use a rag dipped in neutral detergent to fully wipe it, and then dry it with a clean rag. For glass materials, wipe with a rag dampened with water glass cleaner, and then dry with a dry rag.

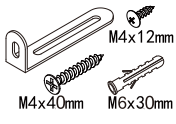
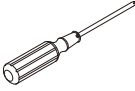
Do not use an electric screwdriver, and do not use too much force when installing, because the board is easy to break.

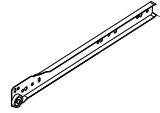
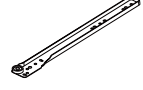
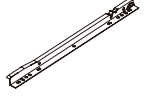
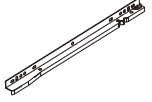
	 15x10mm	 6x30mm	 4x30mm	 3.5x12mm	 4x35mm
Ax72	Bx72	Cx44	Dx48	Ex80	Fx4
		 5x40mm	 4x8mm		 3x14mm
Gx2	Hx8	Jx8	Kx9	Lx9	Mx8
					
Nx2			CLx9	CRx9	DLx9
					
DRx9					

REMARK:

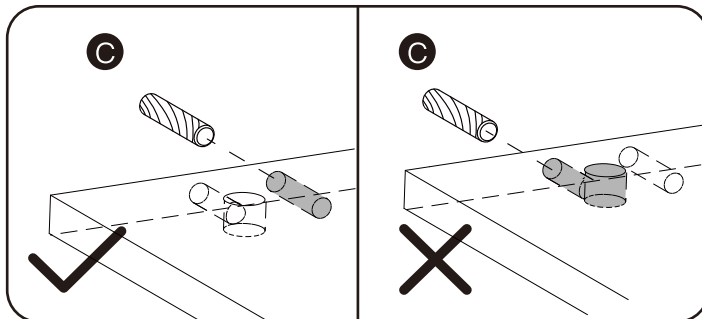

Avoid inserting part C into wrong holes.

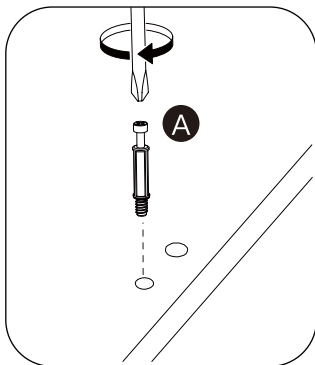

Part A must be installed into the holes with rubber nuts which are smaller than others.

When locking part B, please make sure part A is fully inserted.

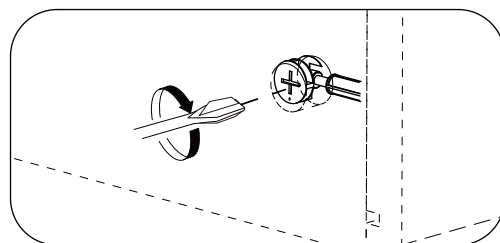
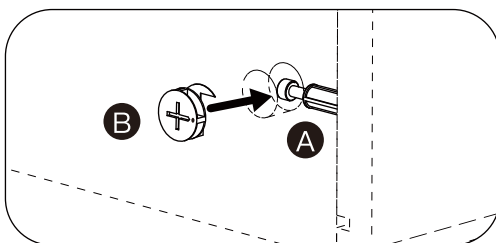

Please check all parts and accessories according to the parts list before assembling, make sure all contents are sufficient and in good condition.

If there is any parts missing or defective, please contact us with purchase platform message immediately to get replacement parts.

PARTS:

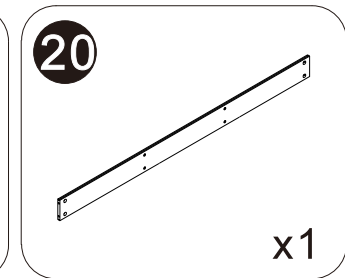
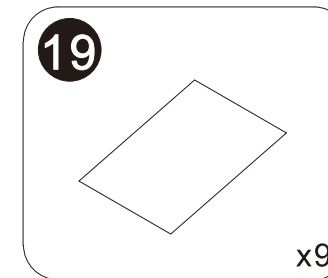
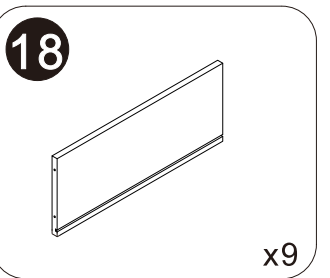
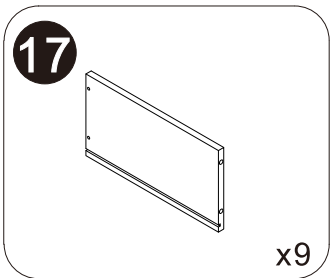
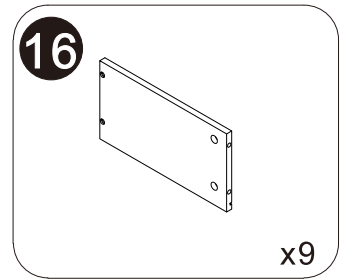
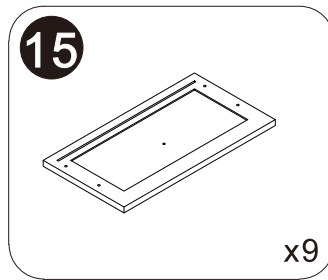
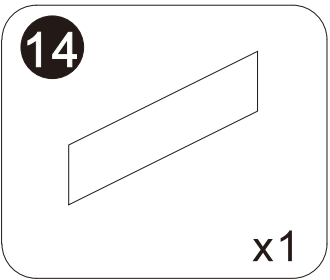
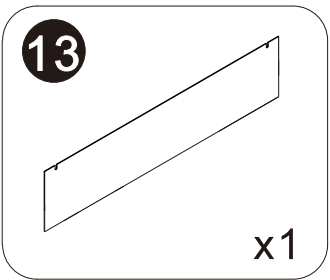
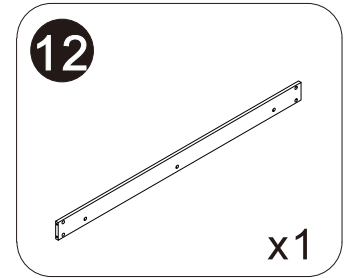
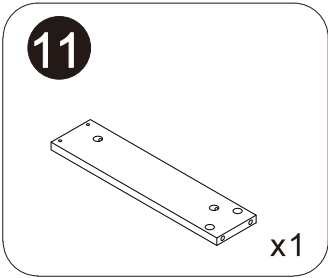
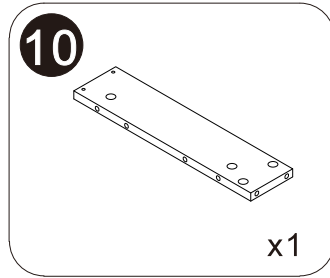
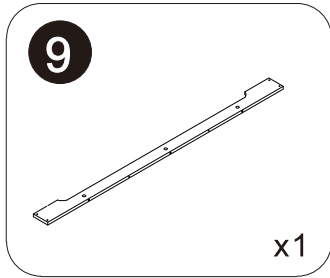
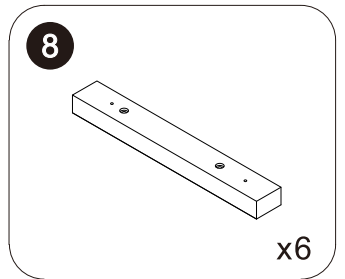
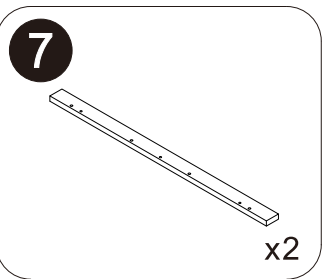
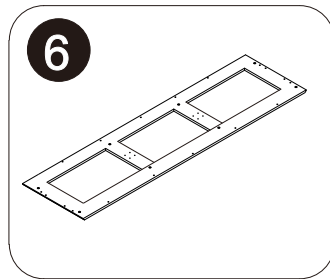
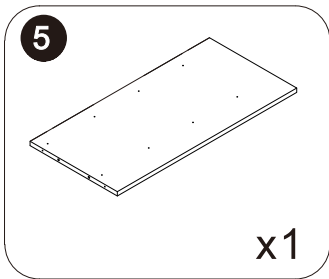
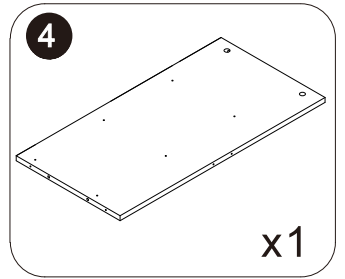
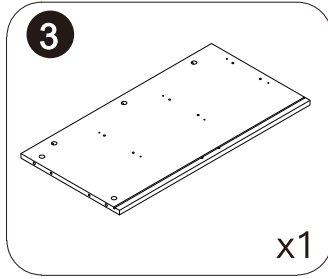
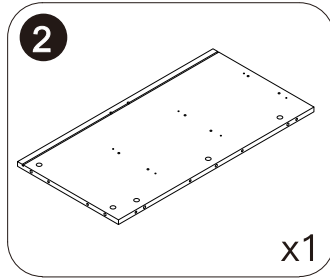
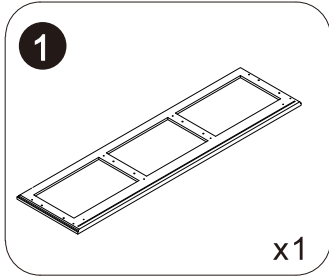

EXPLODED DRAWING:

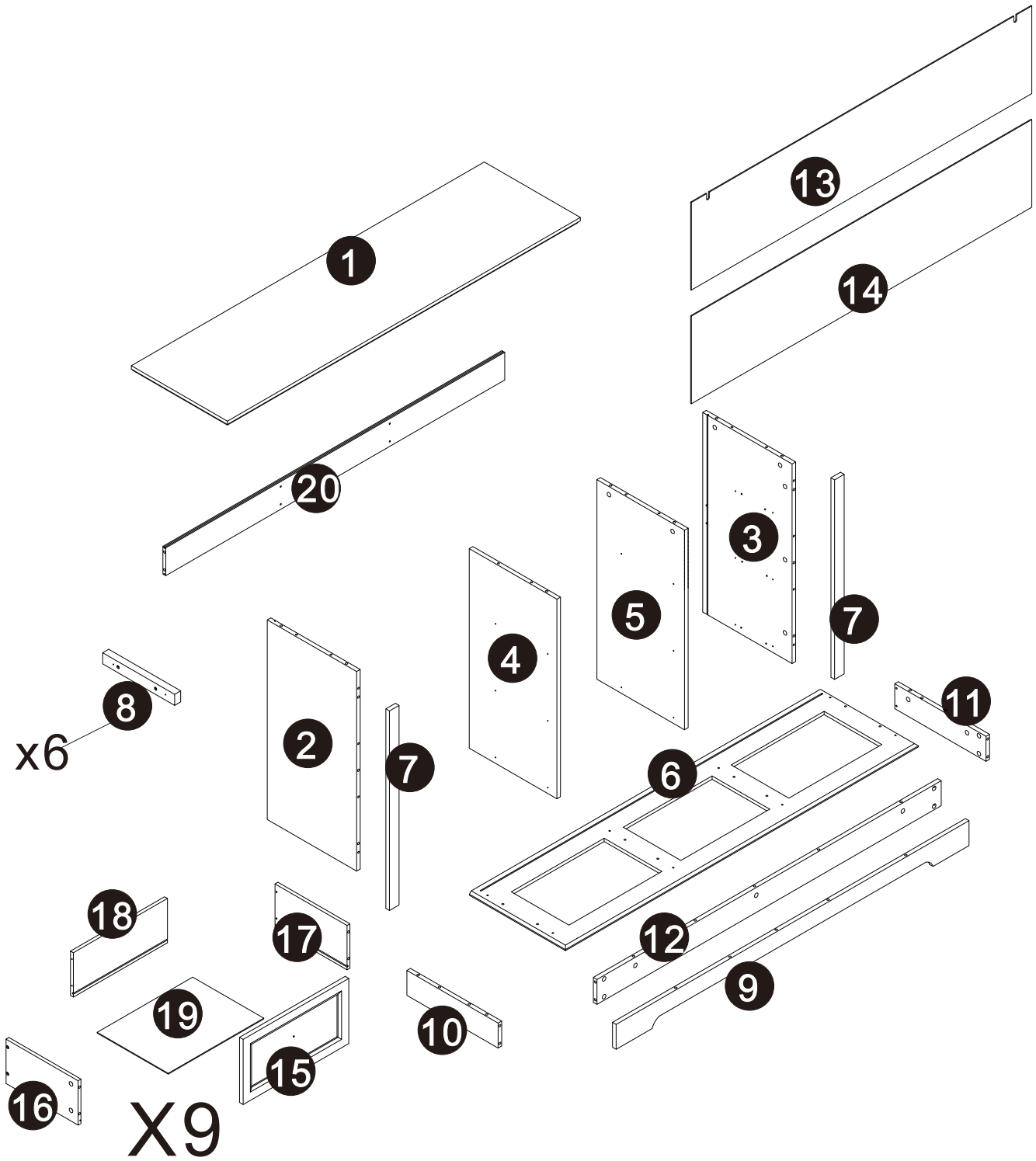

HOW TO INSTALL

NOTICE:

1. Use electric drill for easier installation experience.
2. Please drive the screws in pre-drilled holes.
3. Please strictly follow the instruction and diagram in every step.
4. Make sure every part is on the right position, otherwise it may cause unnecessary problem.
5. Select the proper component via the label on every part while assembling.

REMARK:

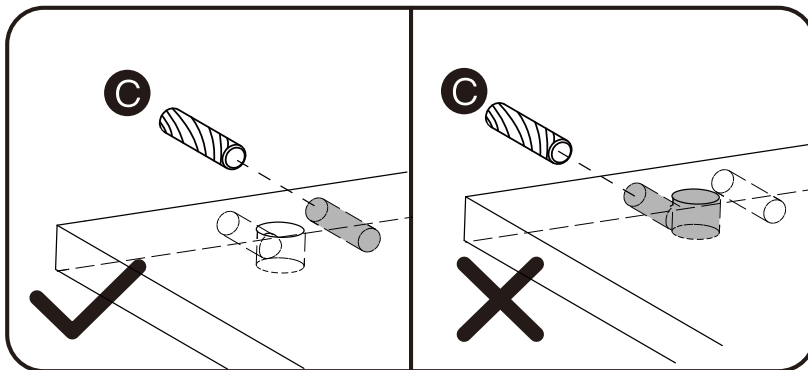

Avoid inserting part **C** into wrong holes.

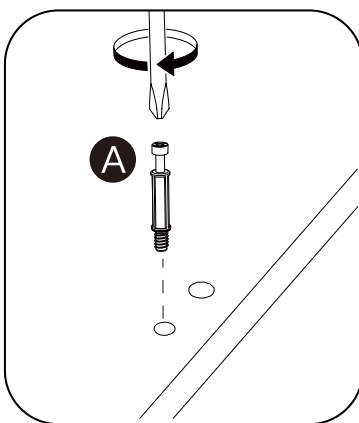

Part **A** must be installed into the holes with rubber nuts which are smaller than others.

When locking part **B**, please make sure part **A** is fully inserted.

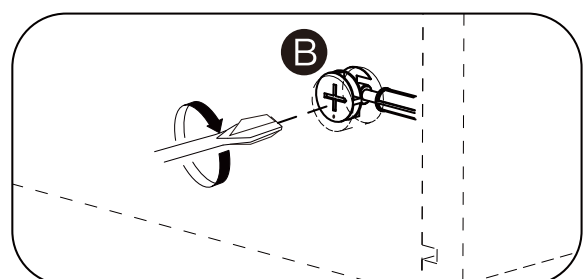
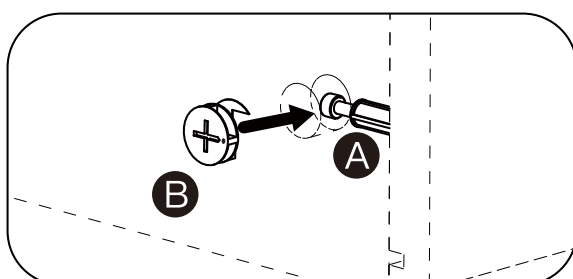

STEP 1

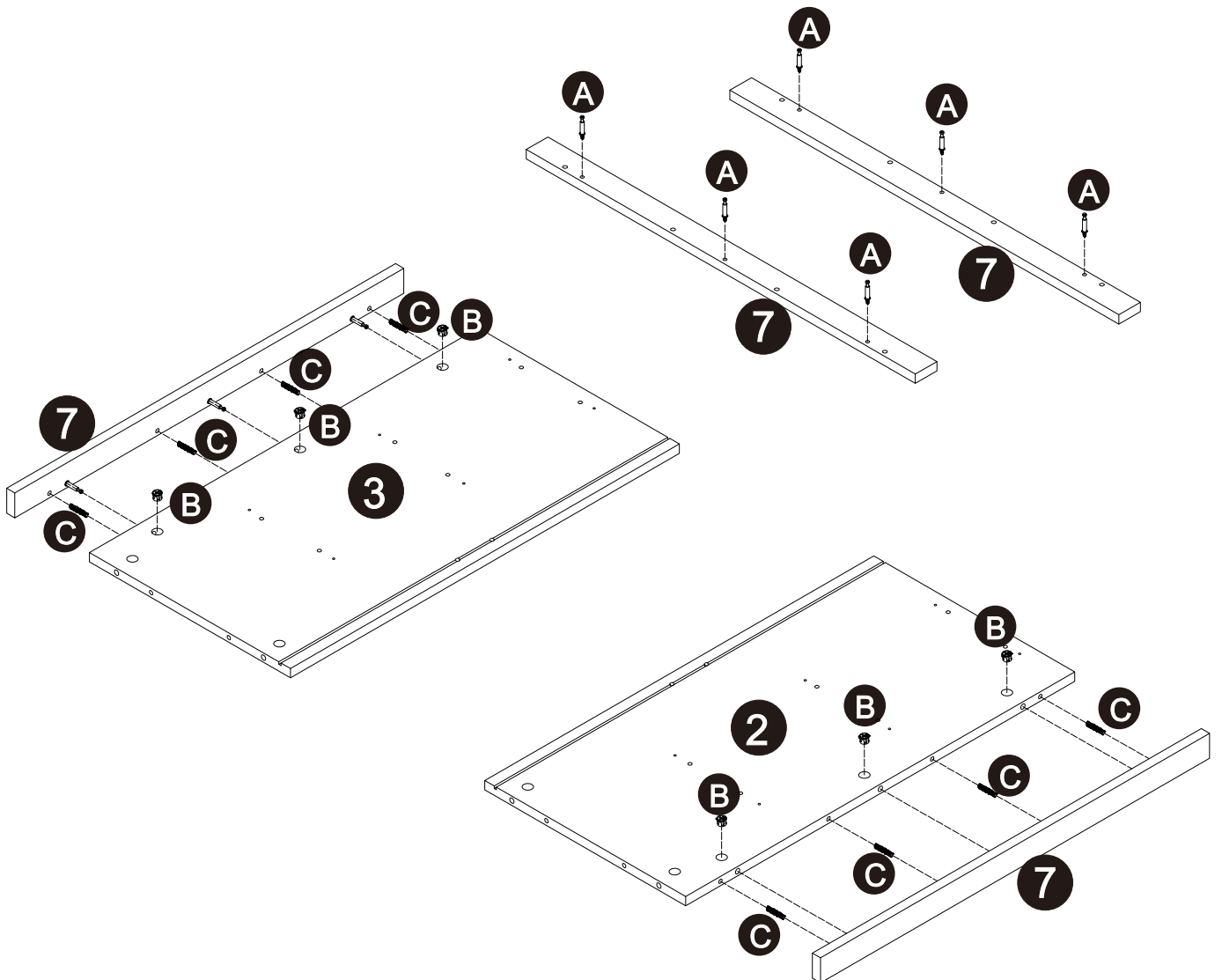
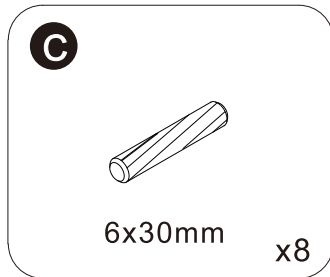
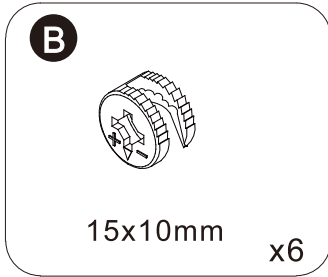
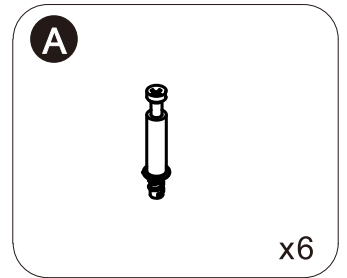
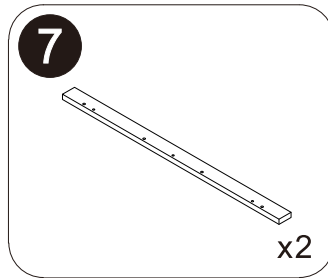
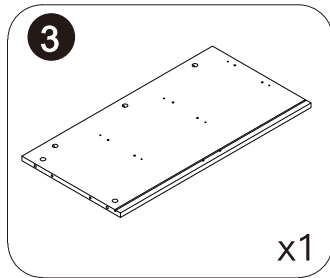
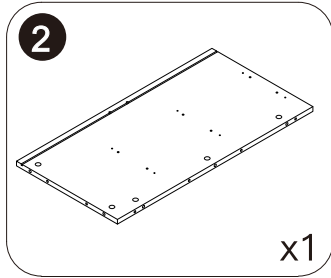

STEP 3

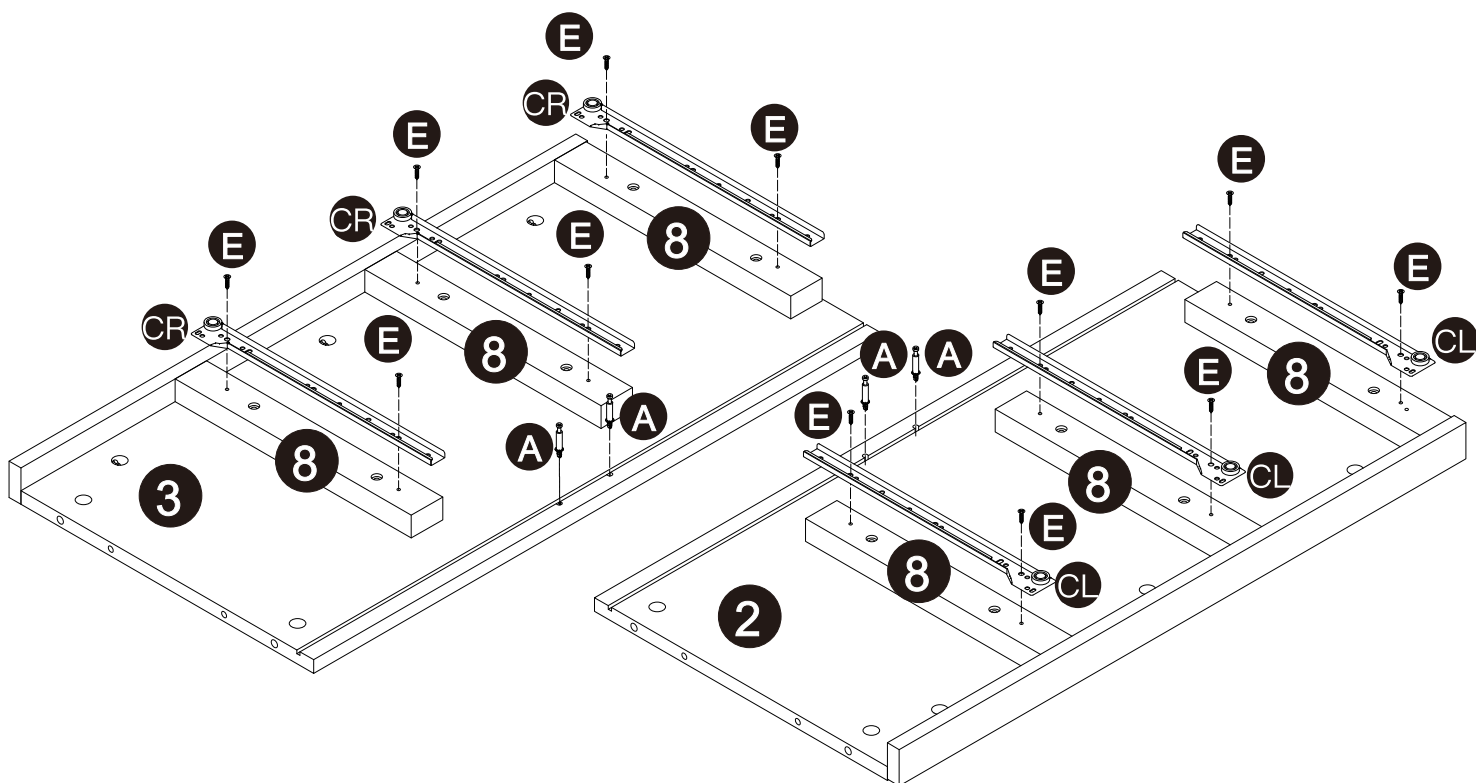
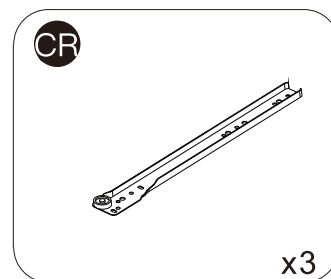
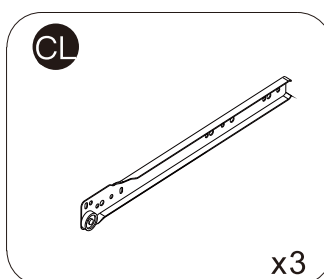
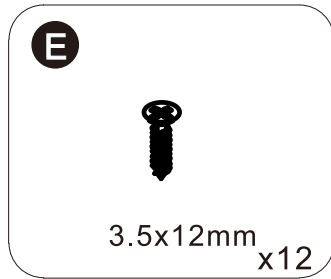
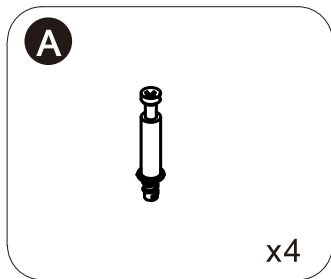

REMARK:

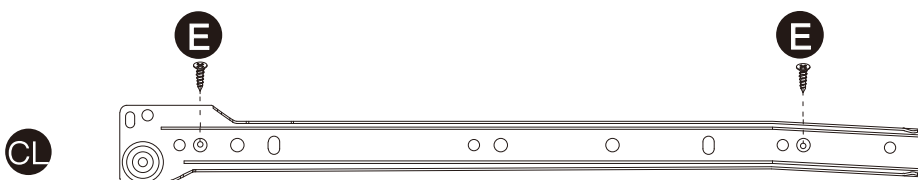
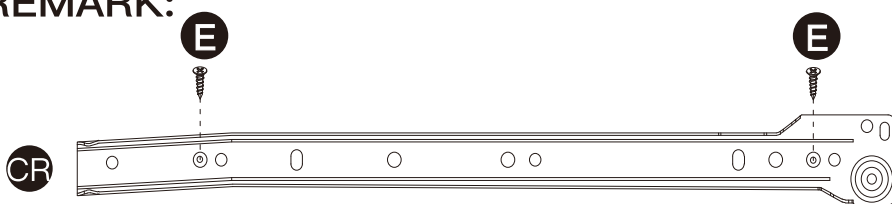

STEP 4

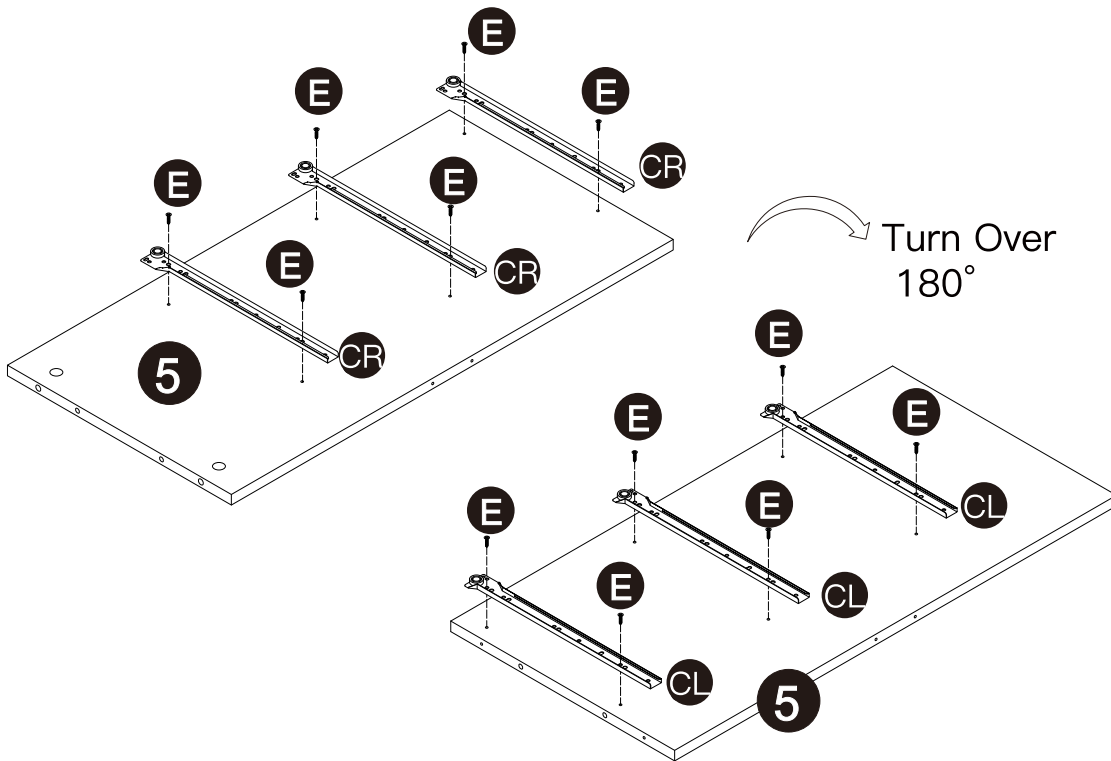
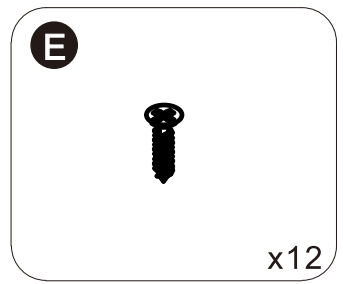
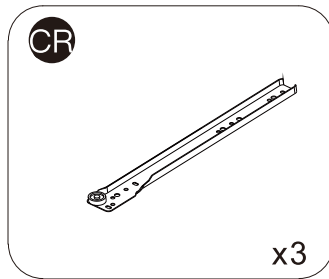
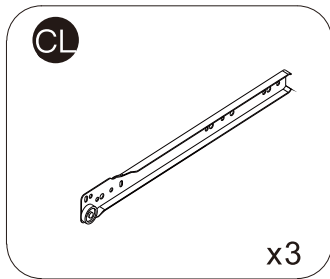
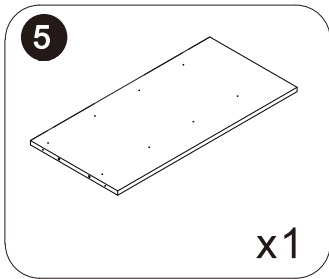

REMARK:

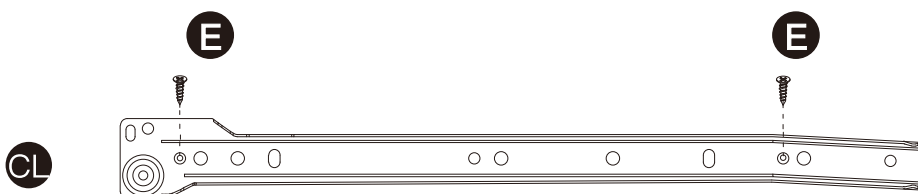
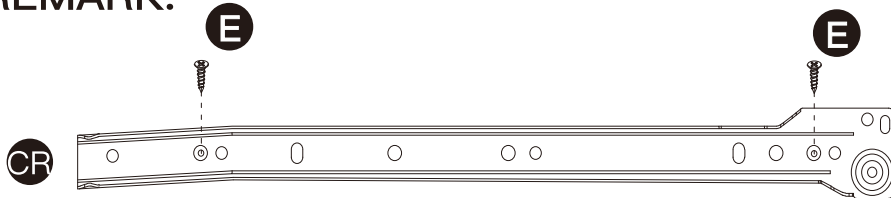

STEP 5

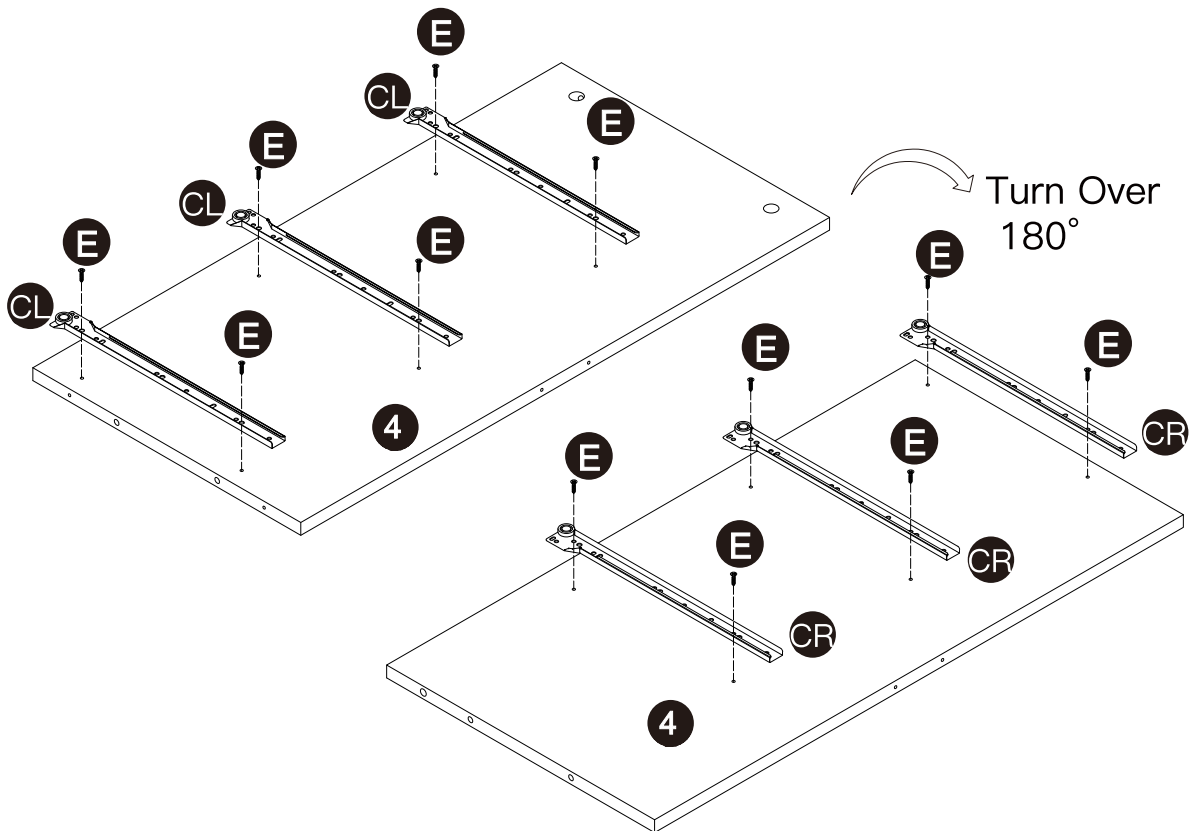
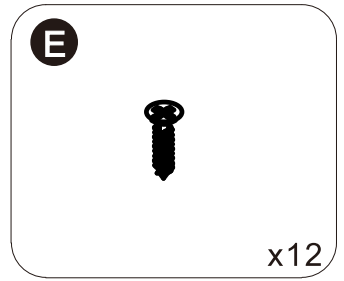
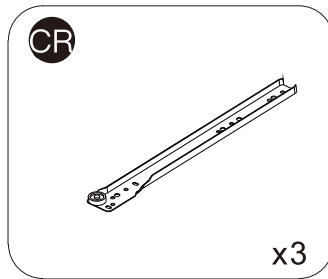
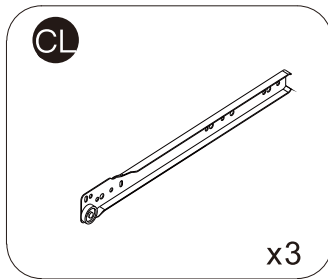
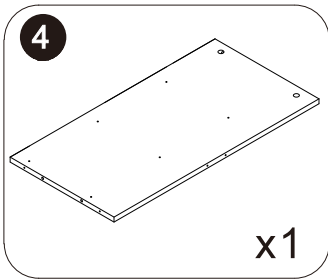

REMARK:

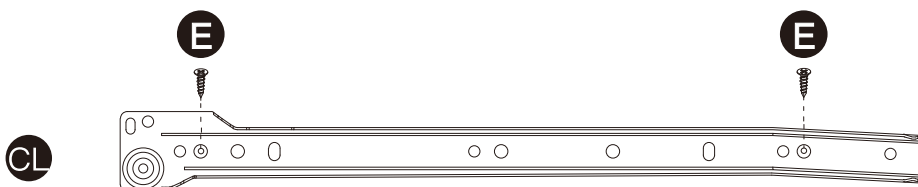
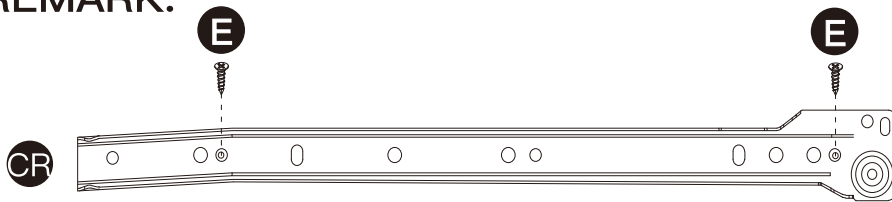

STEP 6

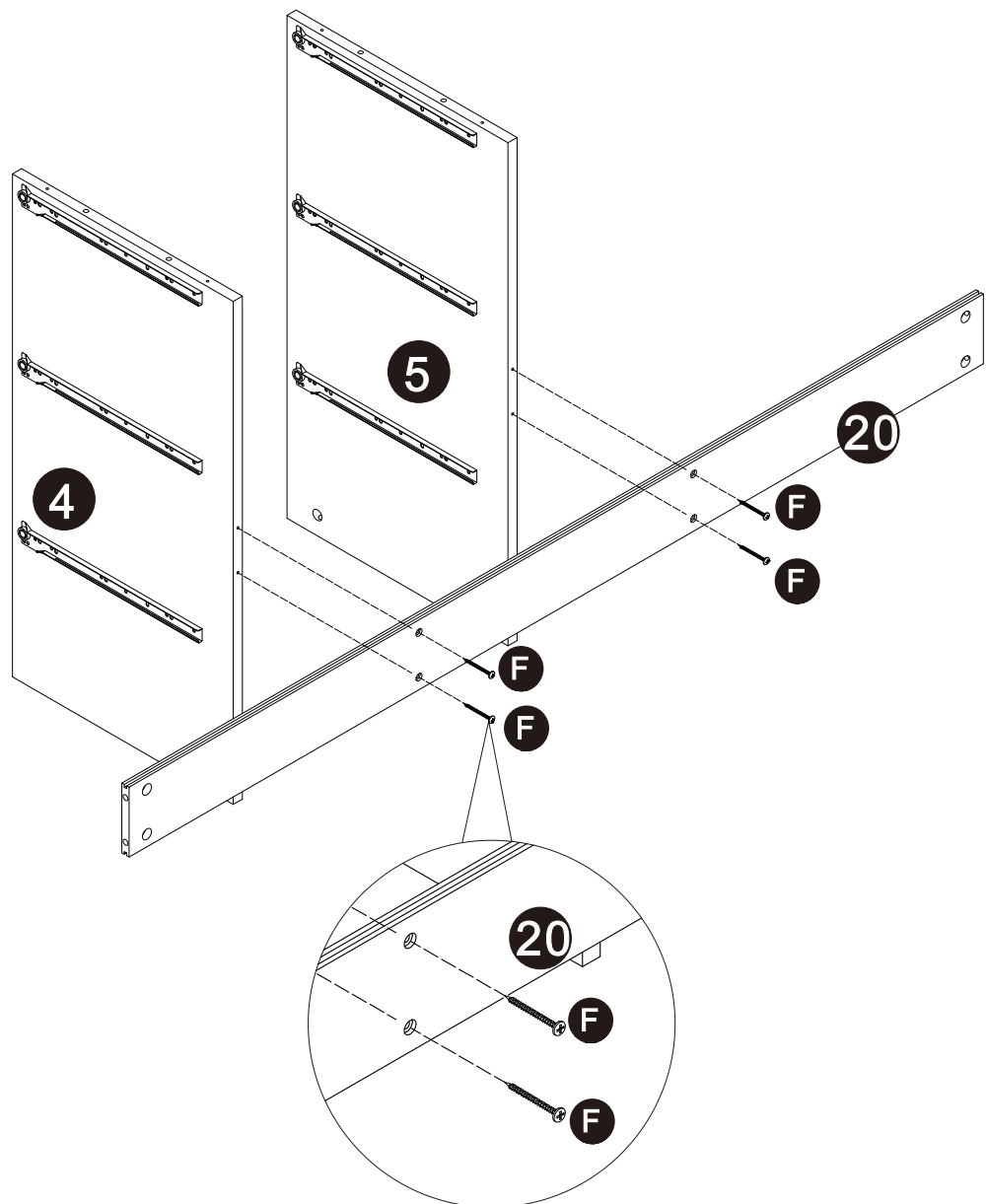
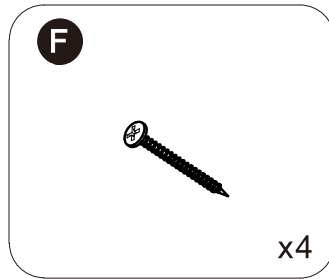
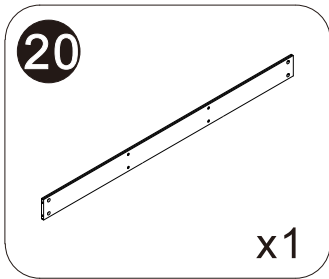

STEP 7

B

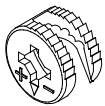

15x10mm x4

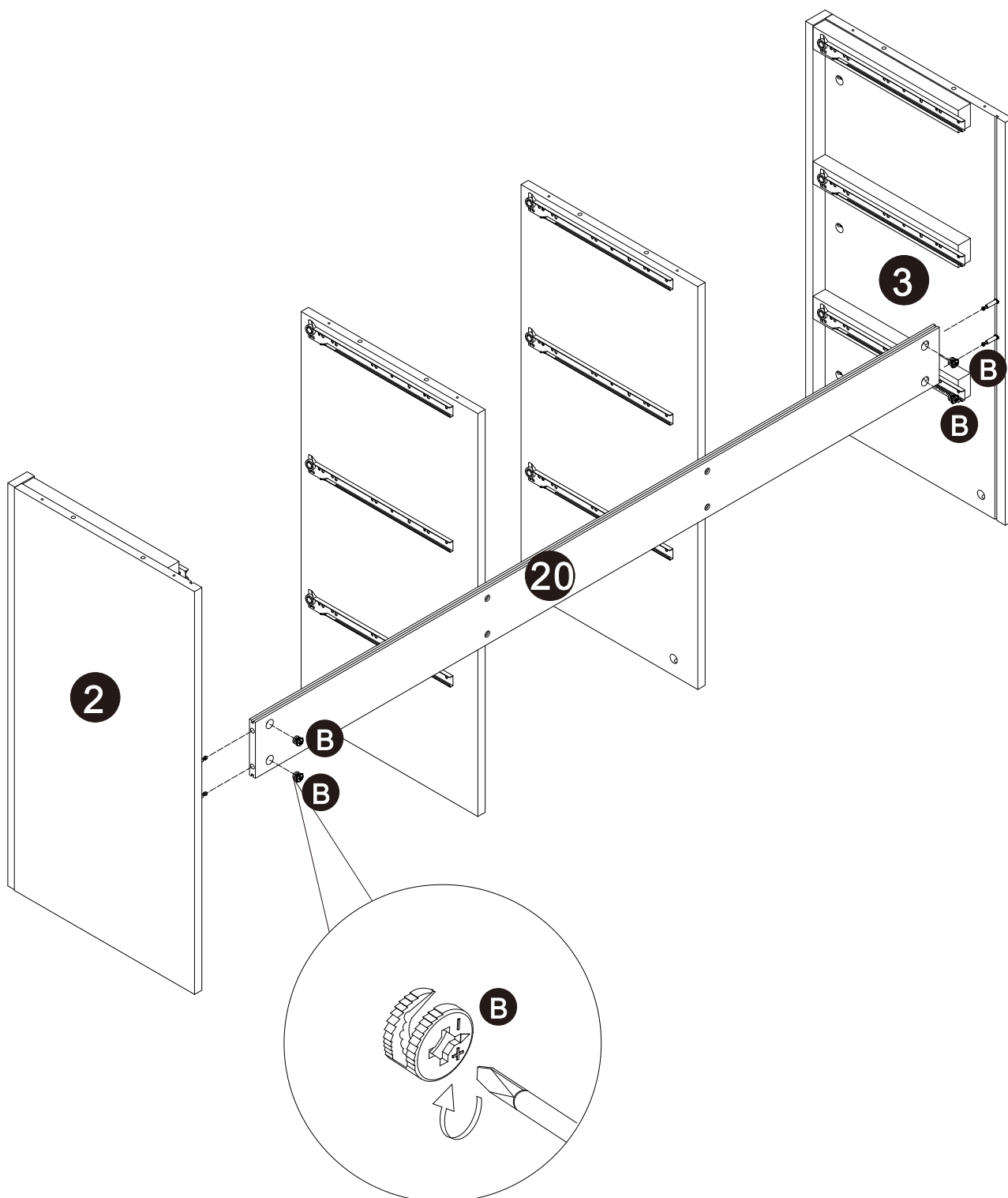

STEP 8

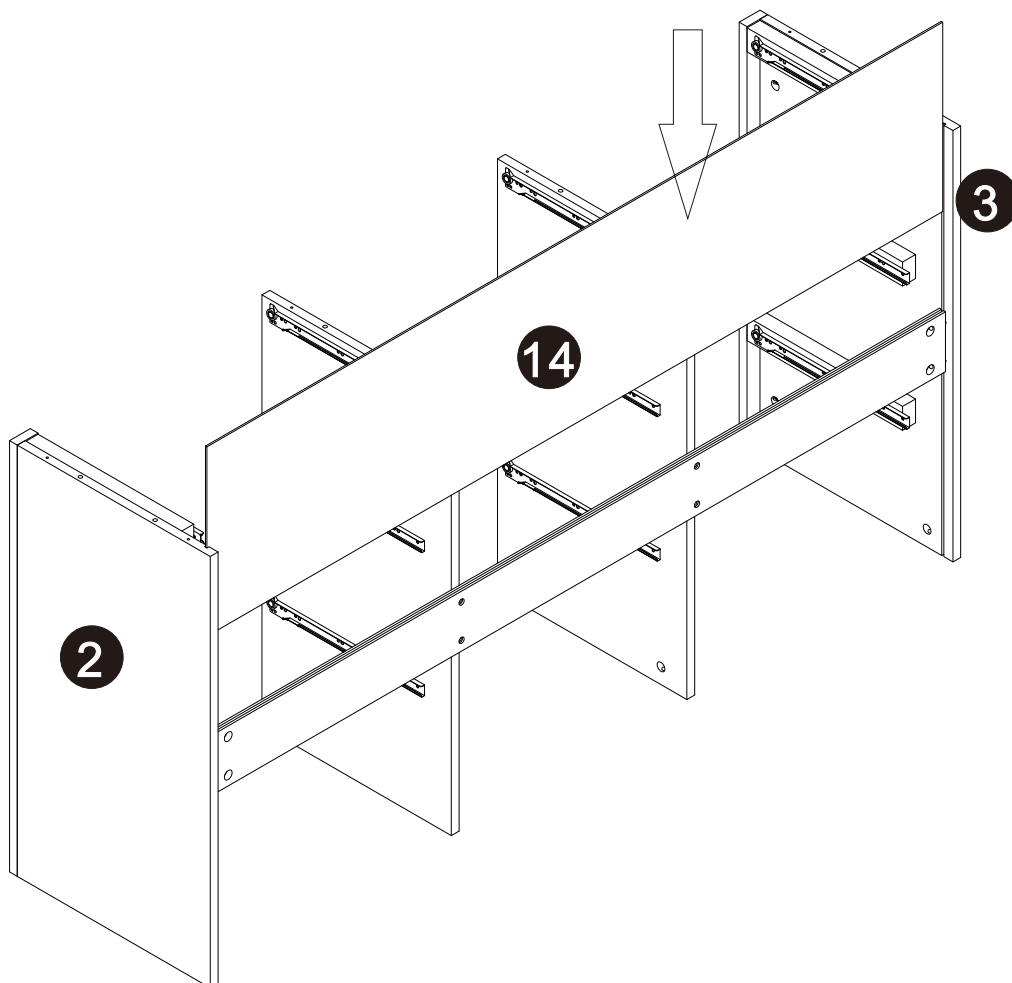
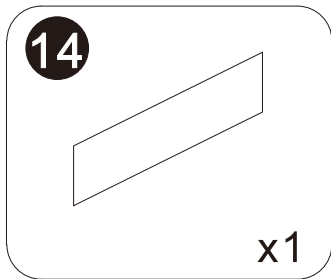

STEP 9

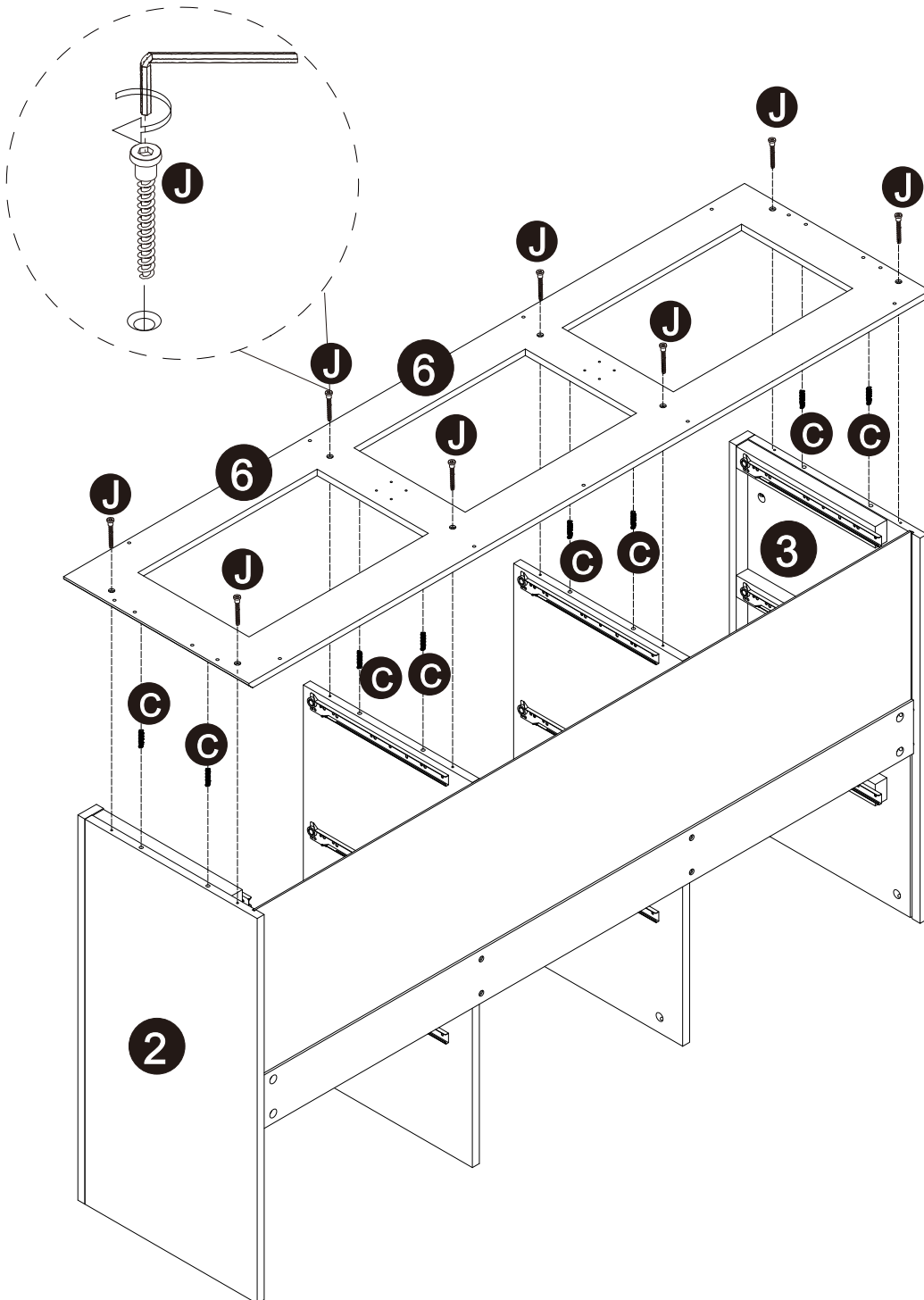
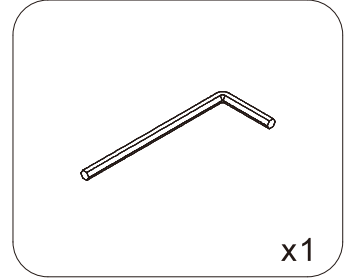
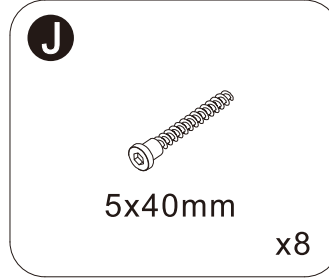
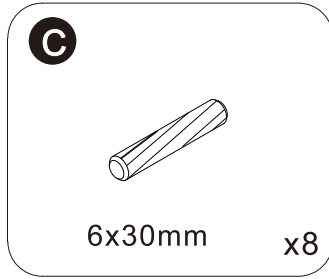
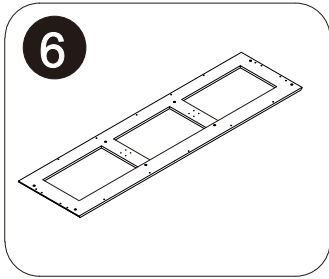

STEP 10

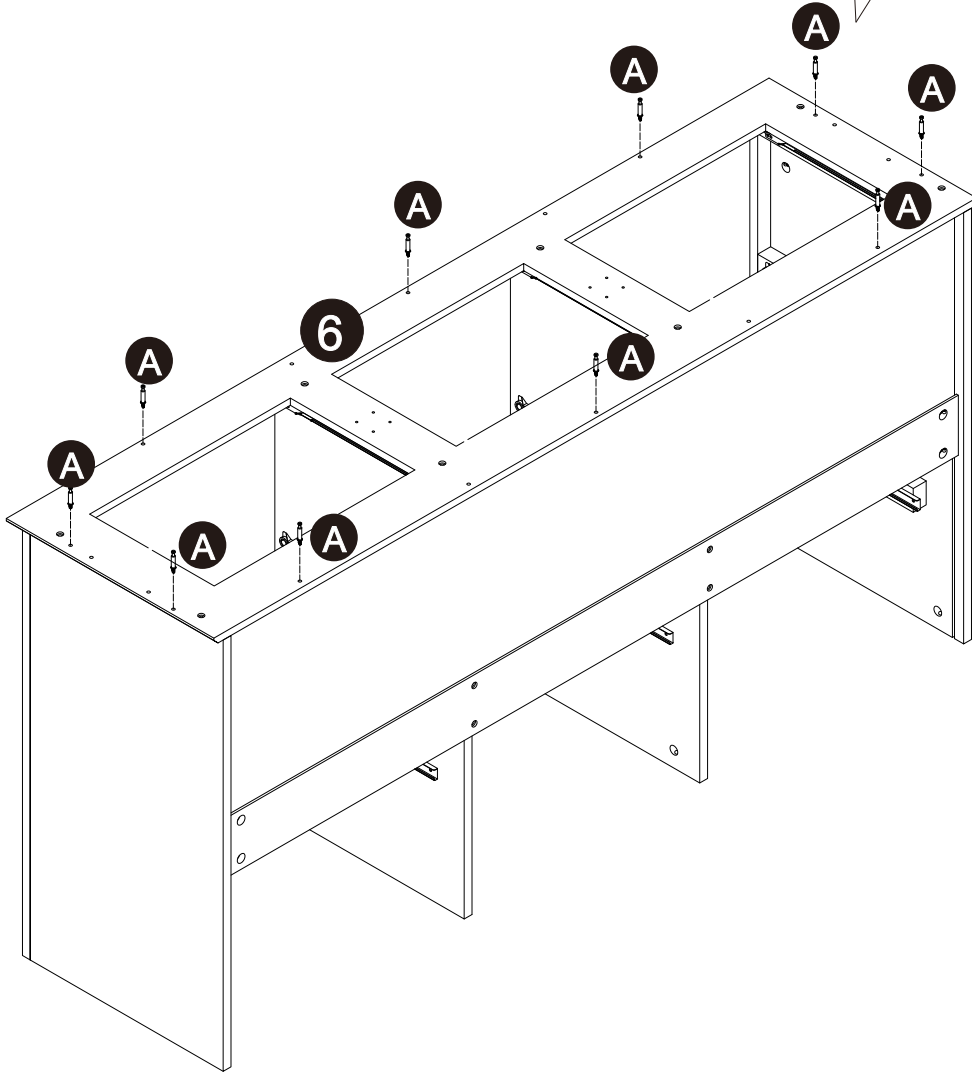
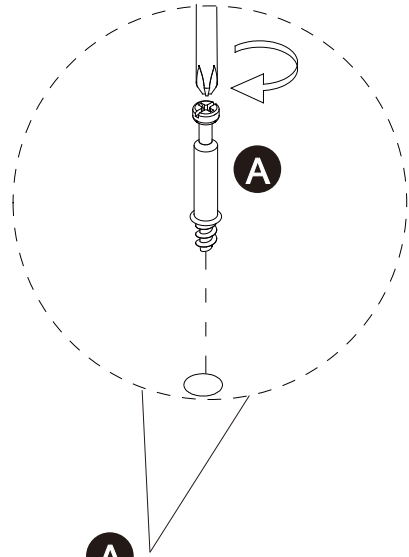
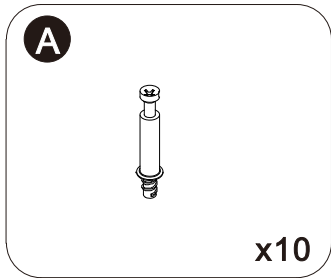

STEP 11

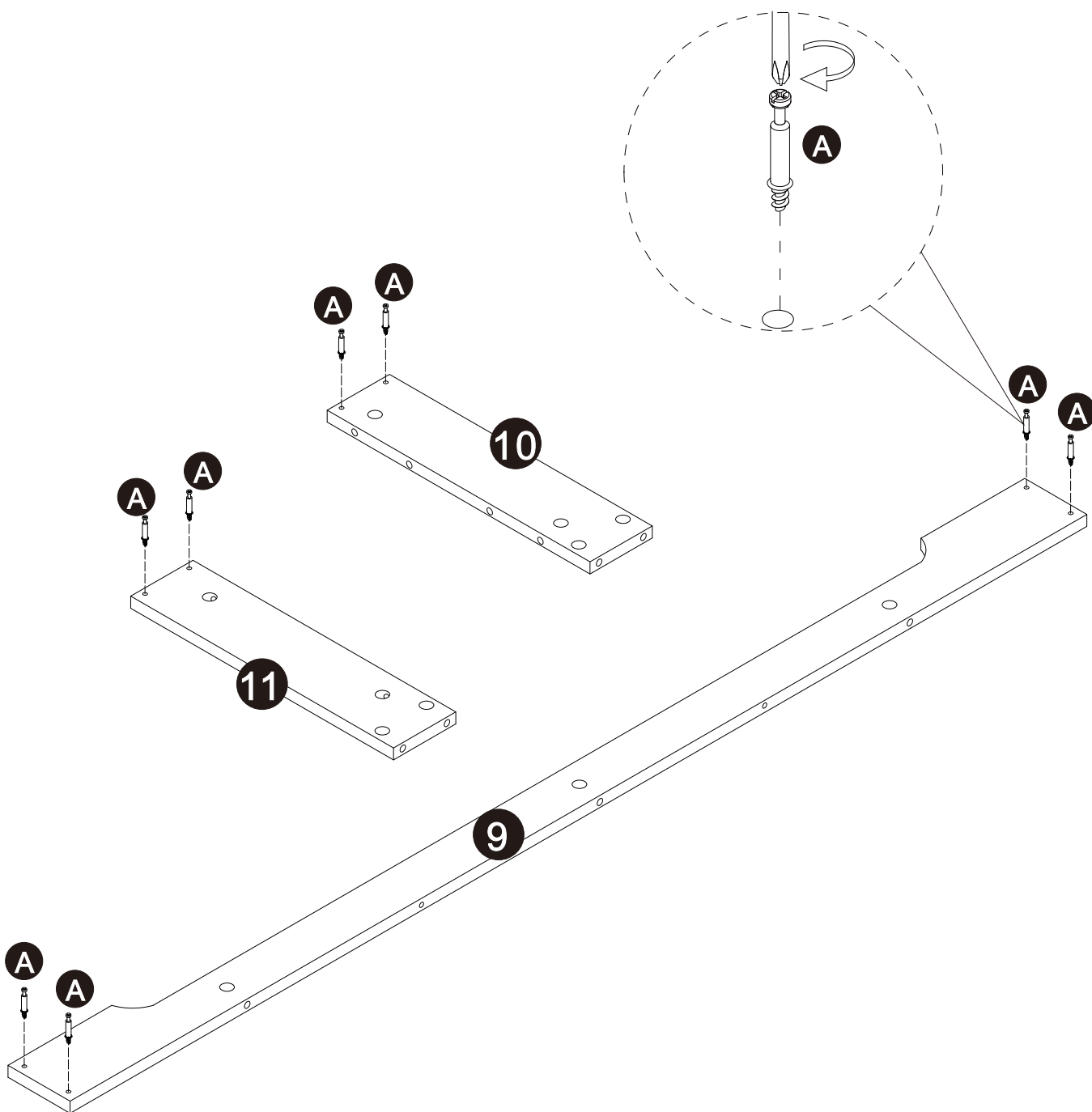
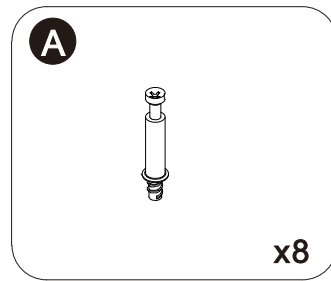
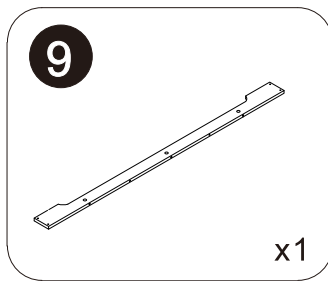
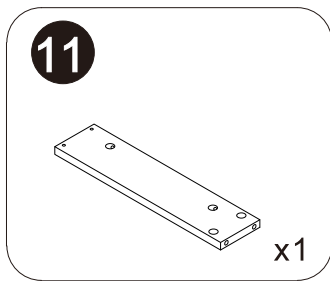
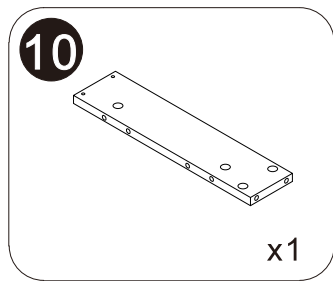

STEP 13

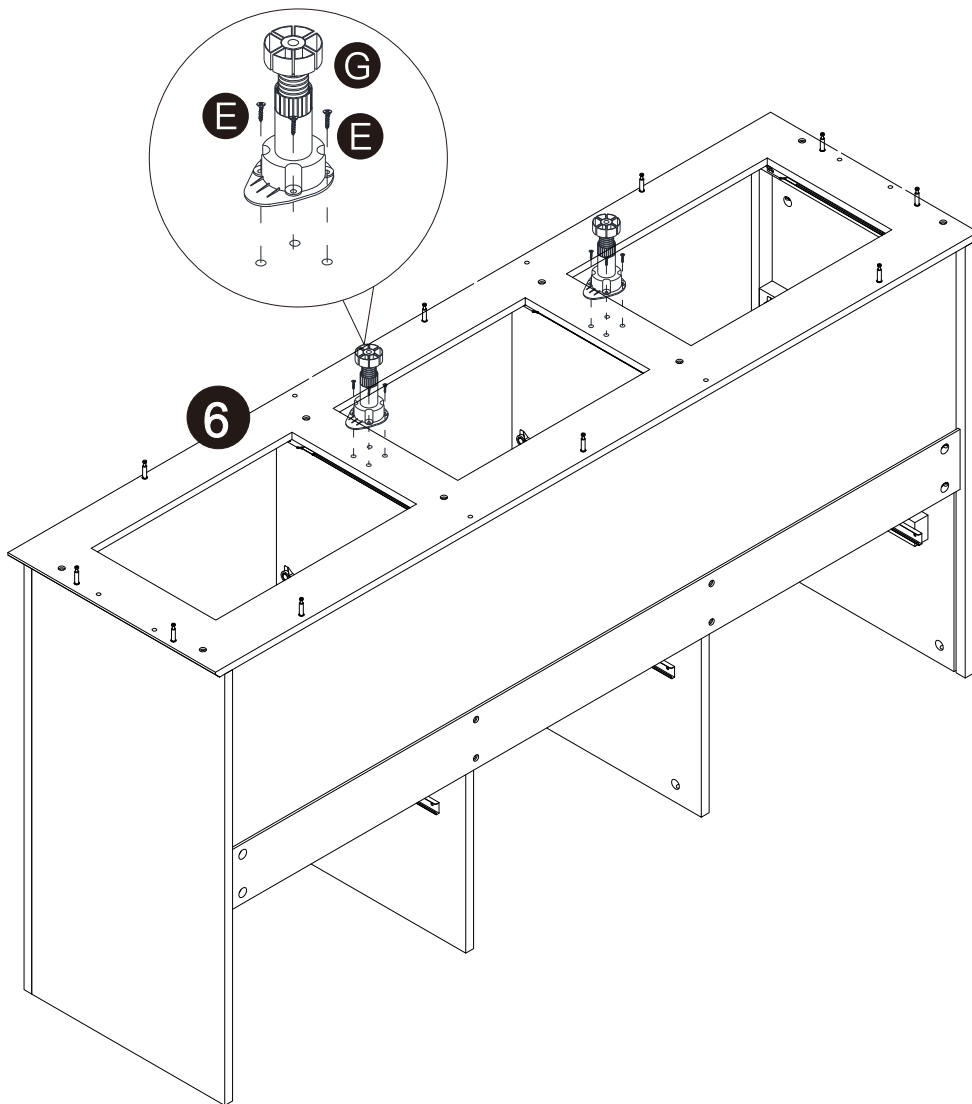
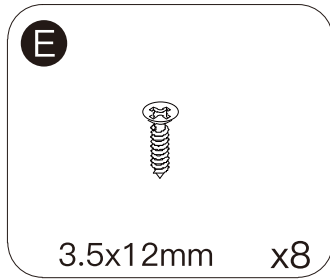
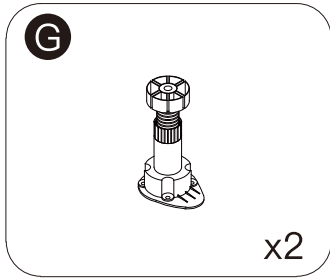

STEP 14

B

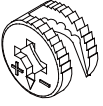

15x10mm
x10

C

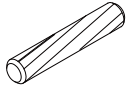

6x30mm
x8

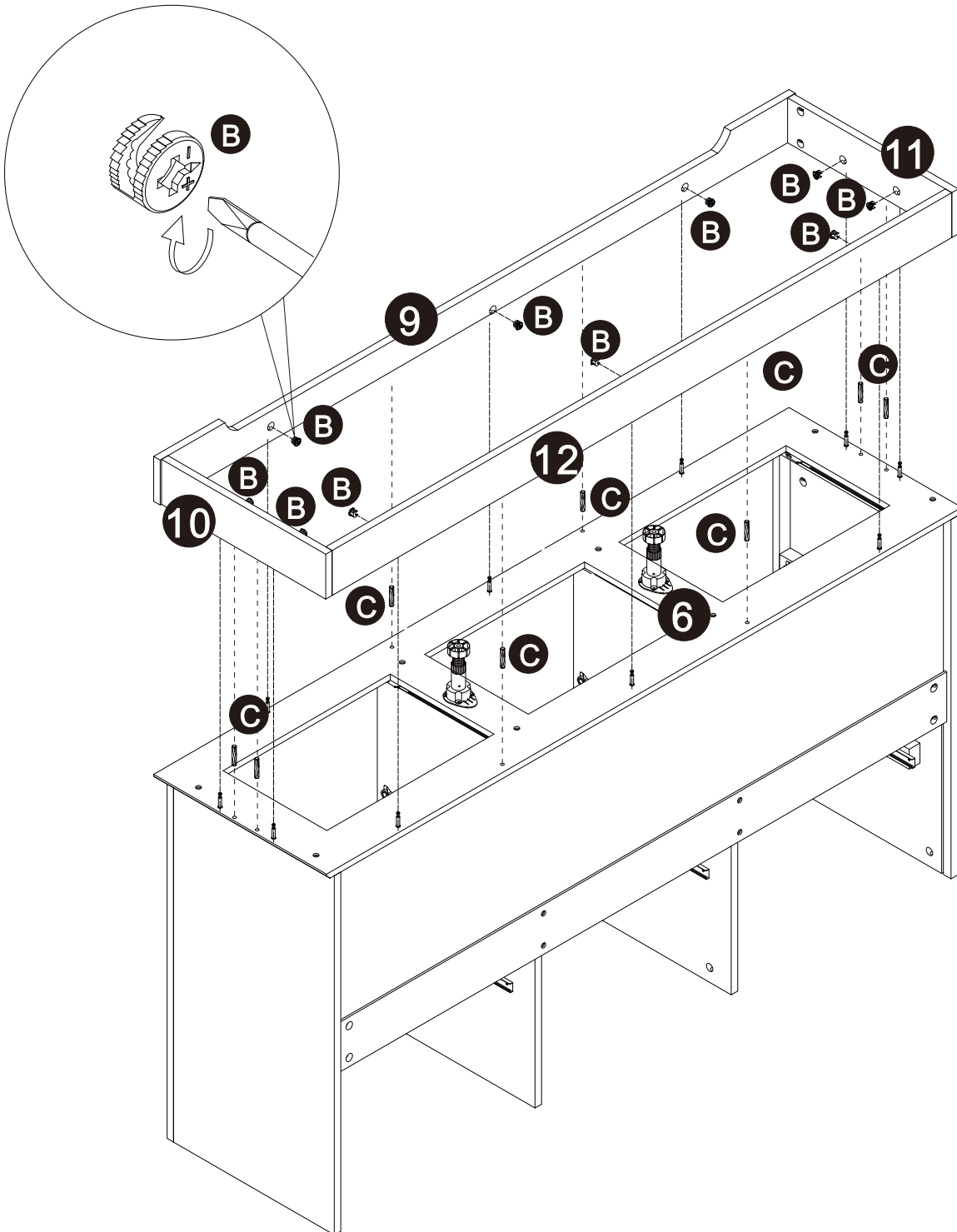

STEP 15

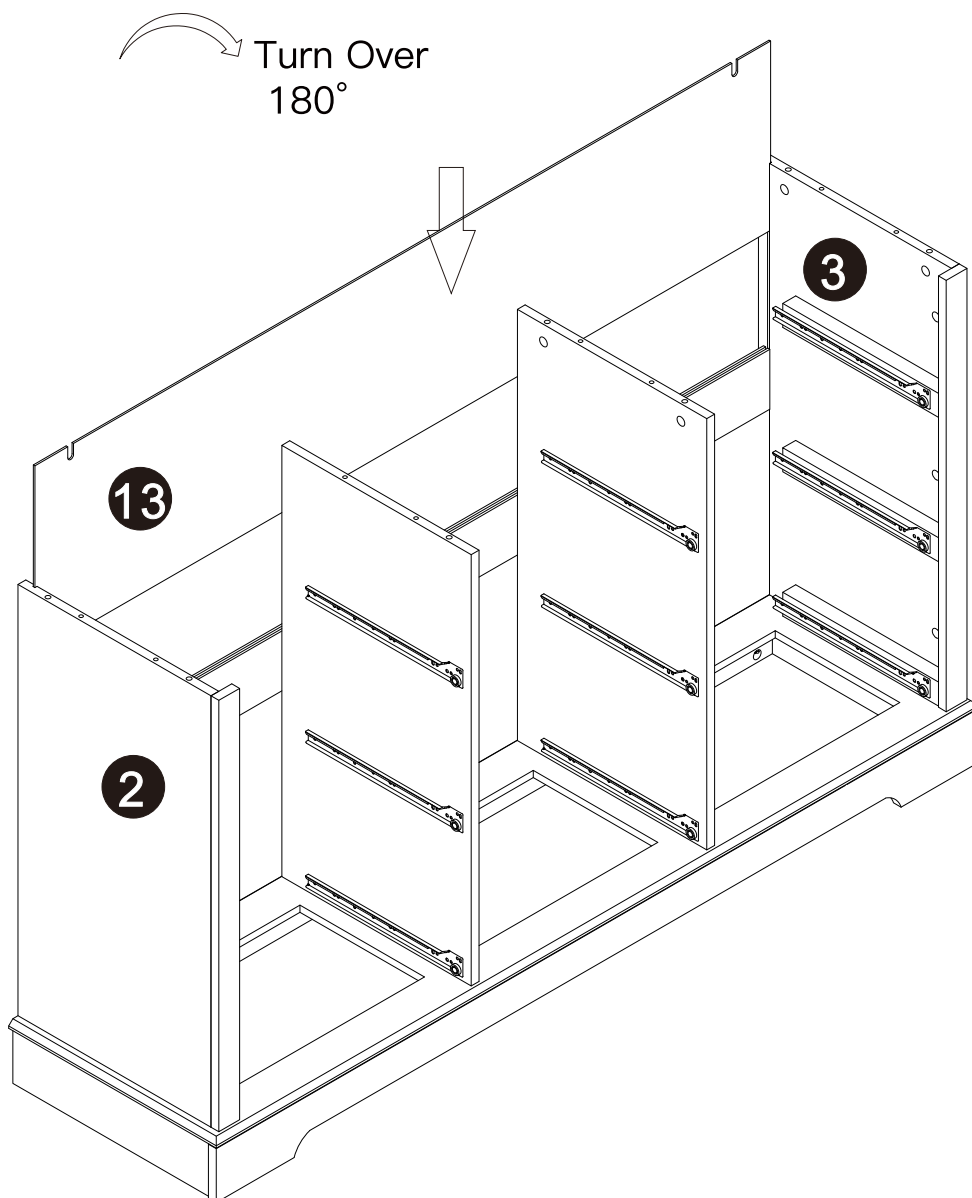
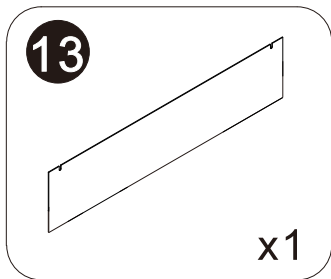

STEP 16

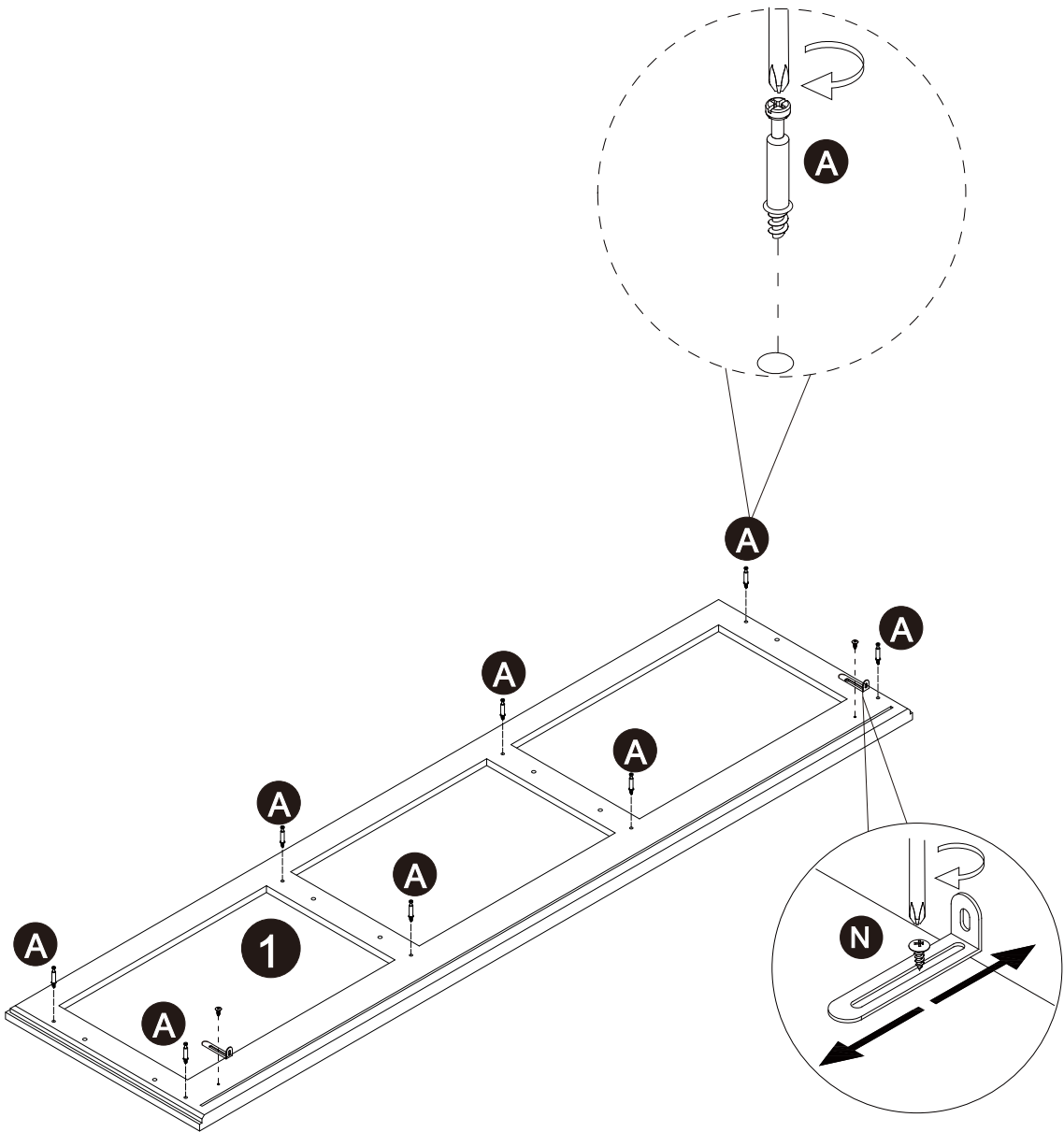
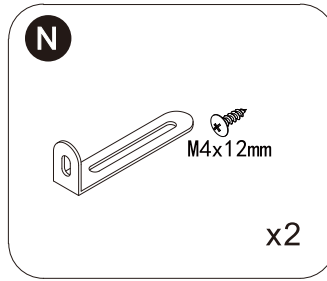
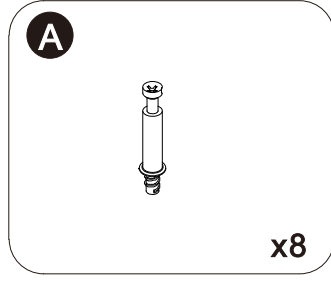
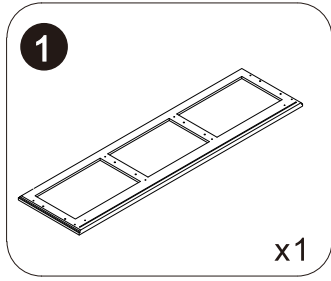

STEP 17

B

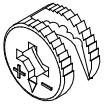

15x10mm

x8

C

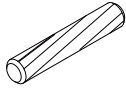

6x30mm

x8

Turn Over
180°

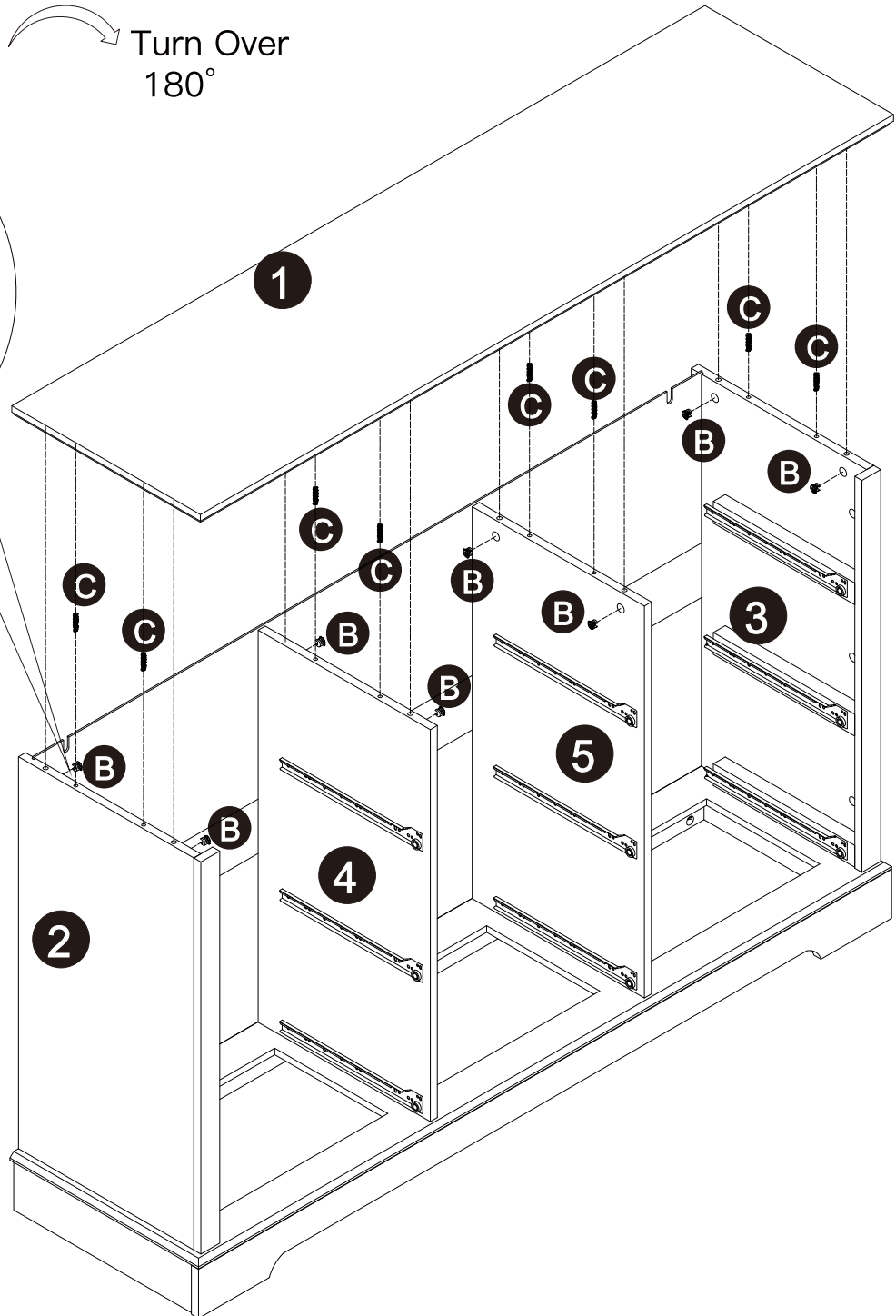
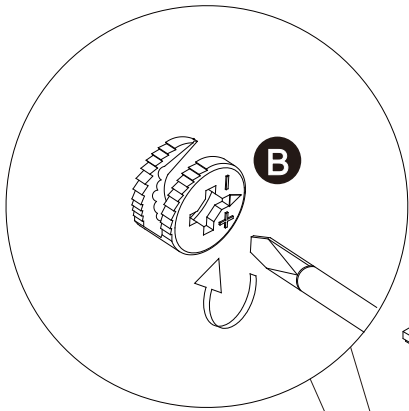

STEP 18

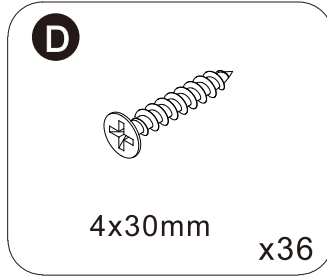
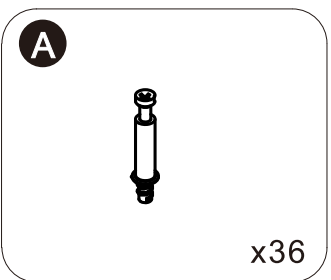
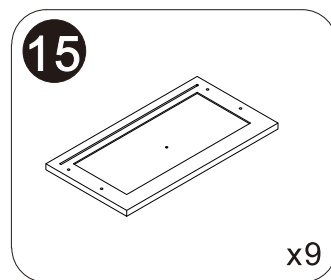
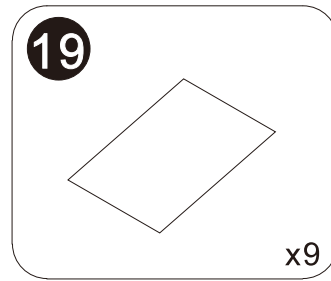
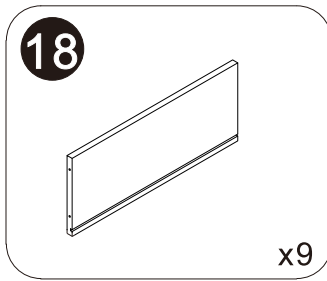
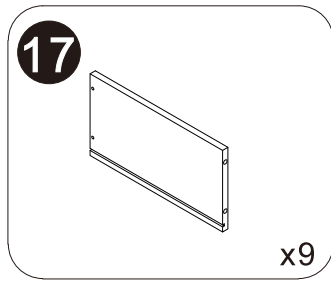
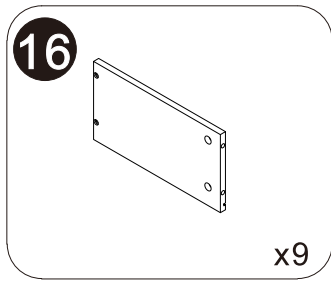

x9

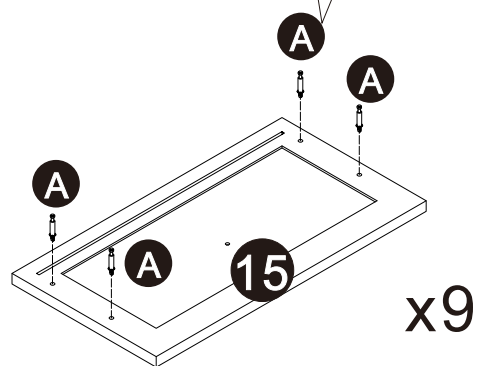
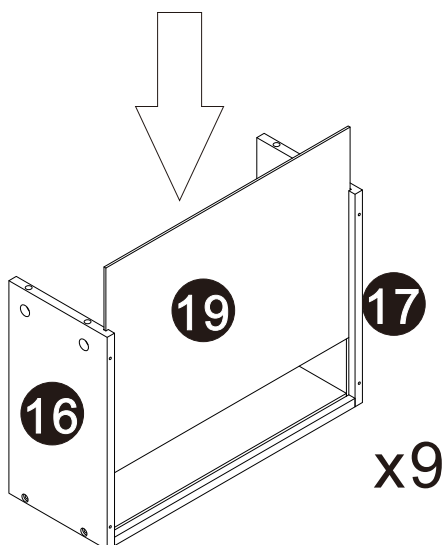
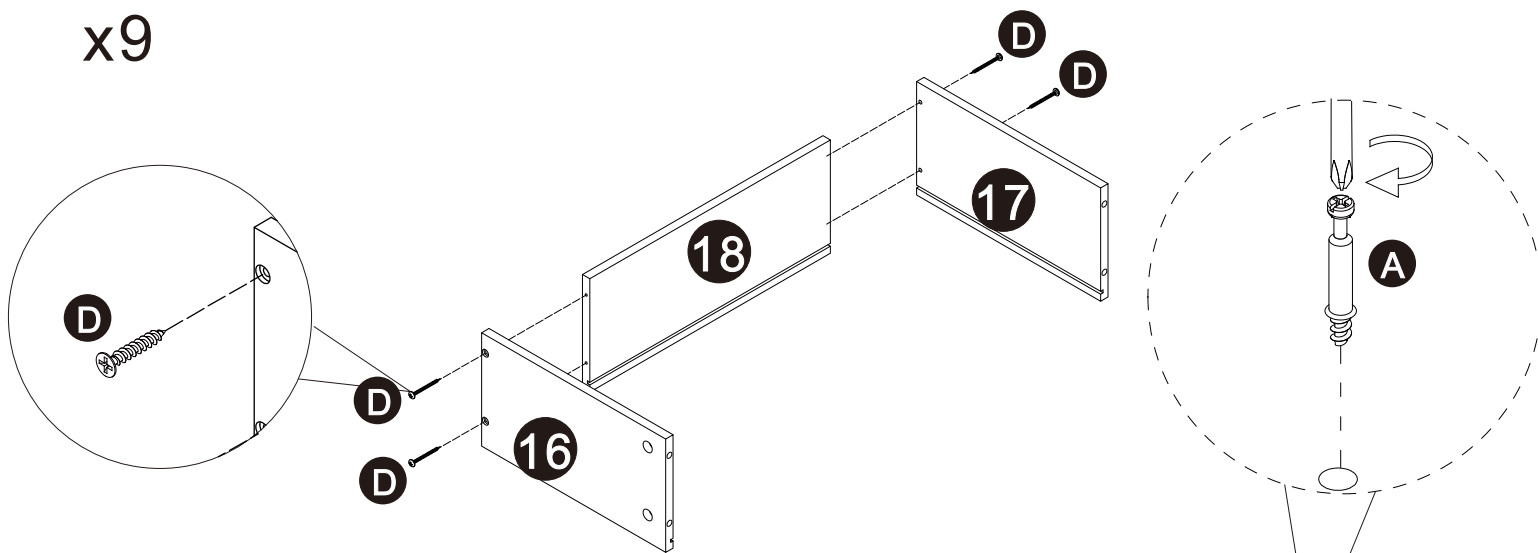

STEP 19

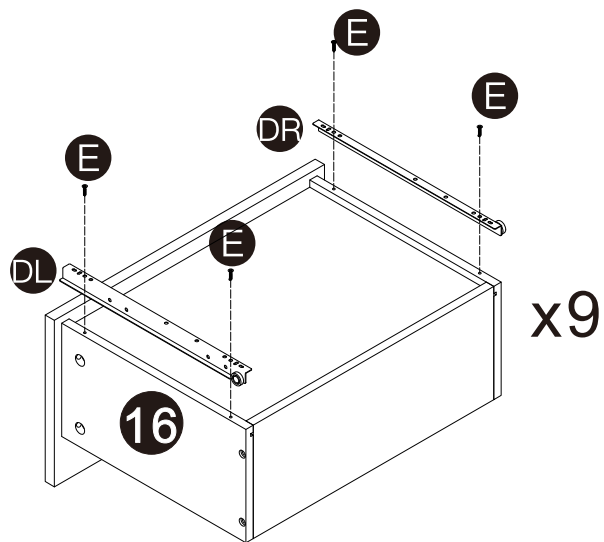
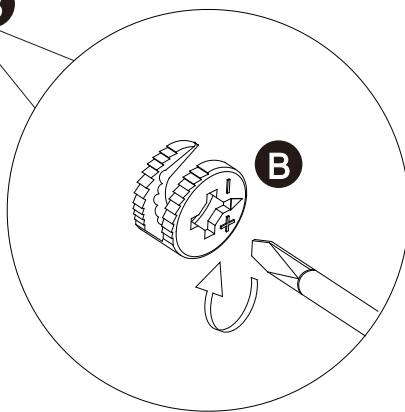
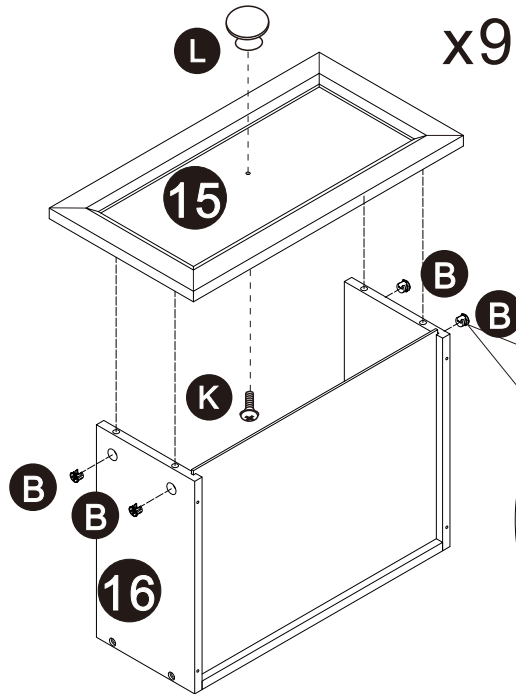
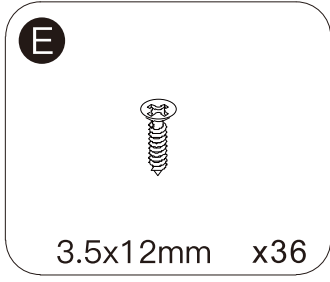
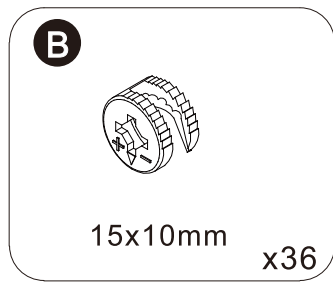
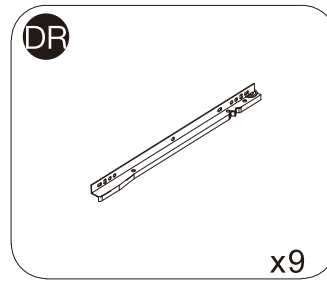
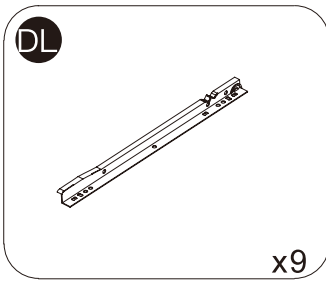
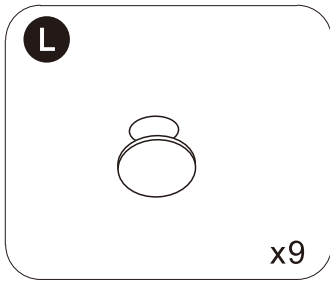
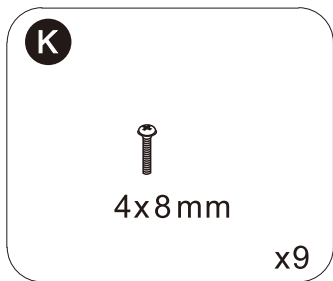

REMARK:

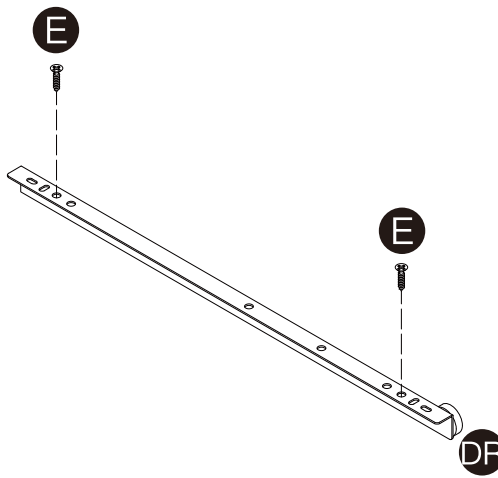
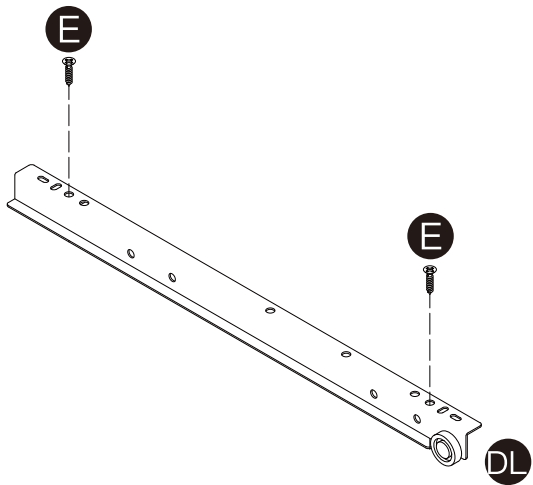

STEP 20

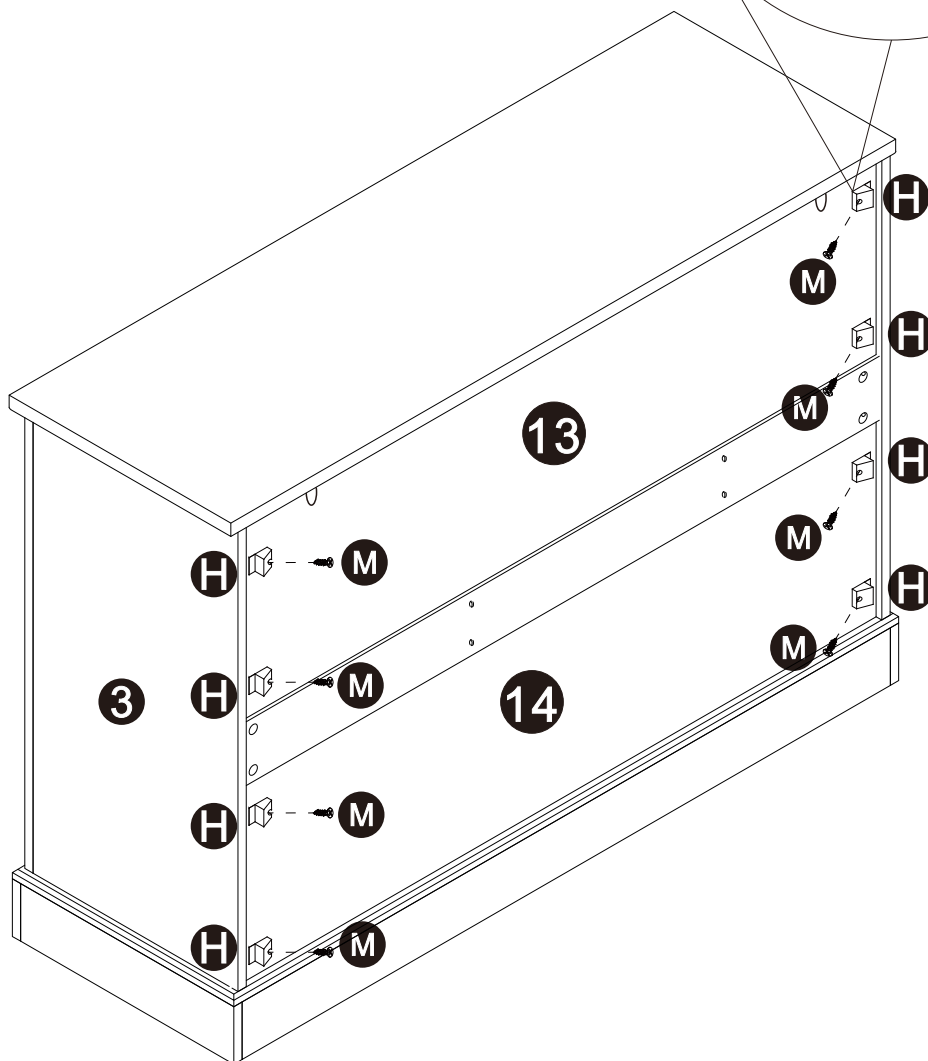
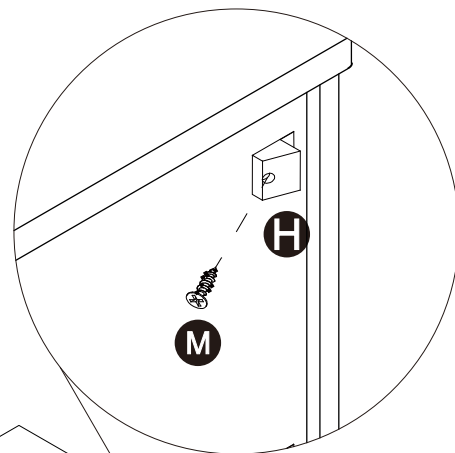
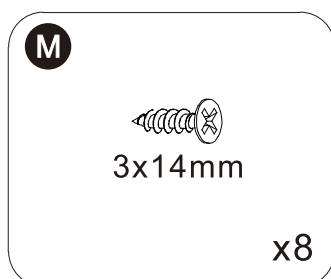
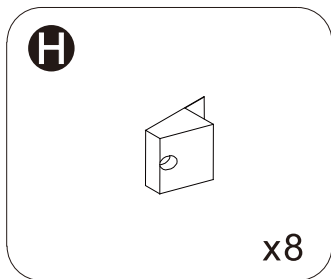

Notice:

After this step, stand up the product, adjust the support legs (part **G**) to make the product stable on the floor.

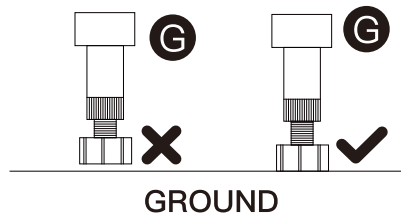

STEP 21

N



x2

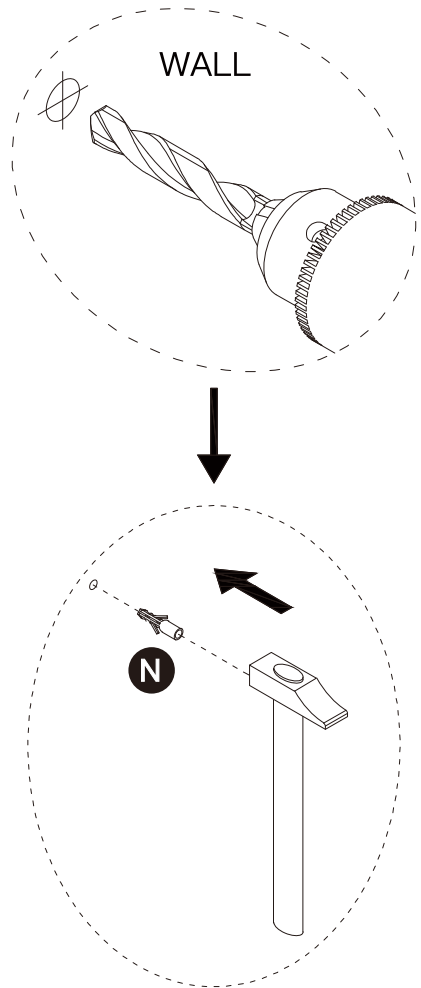
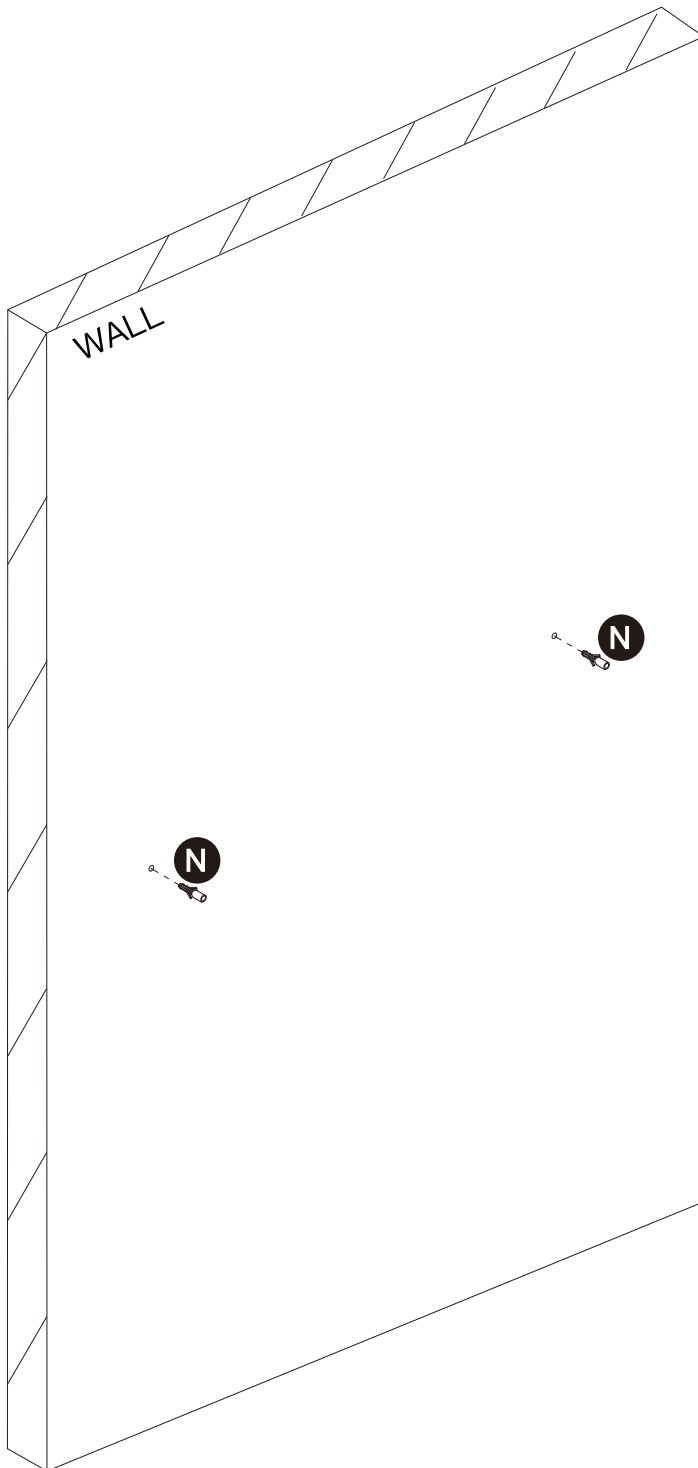

STEP 22

N



M4x40mm

x2

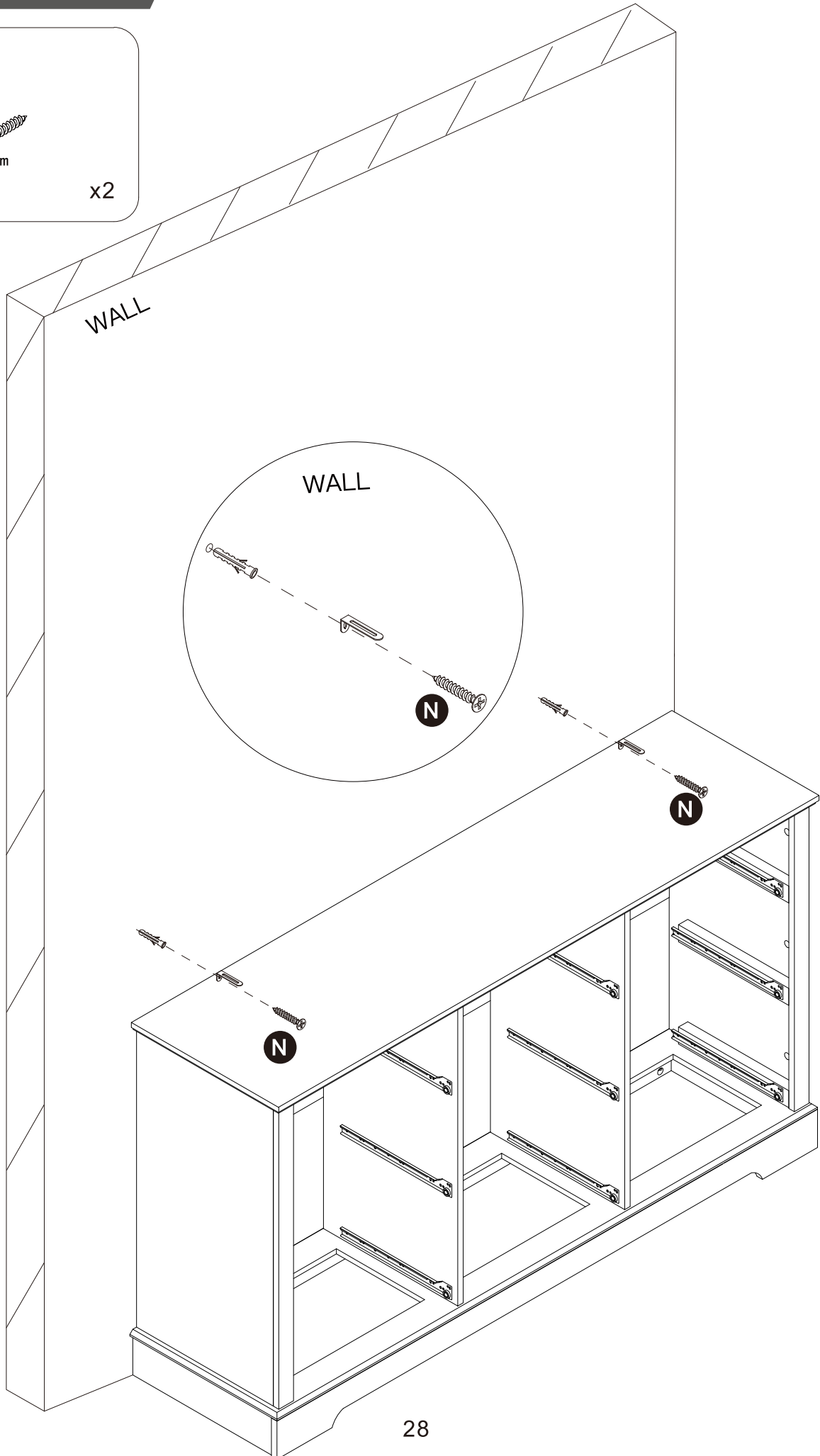

STEP 23

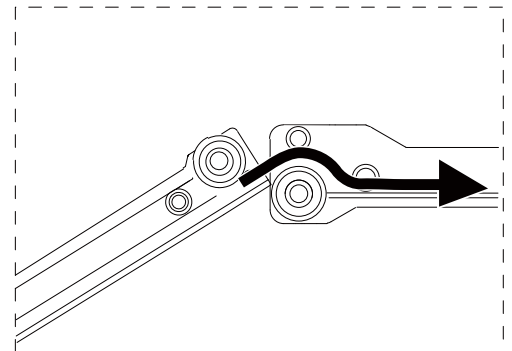
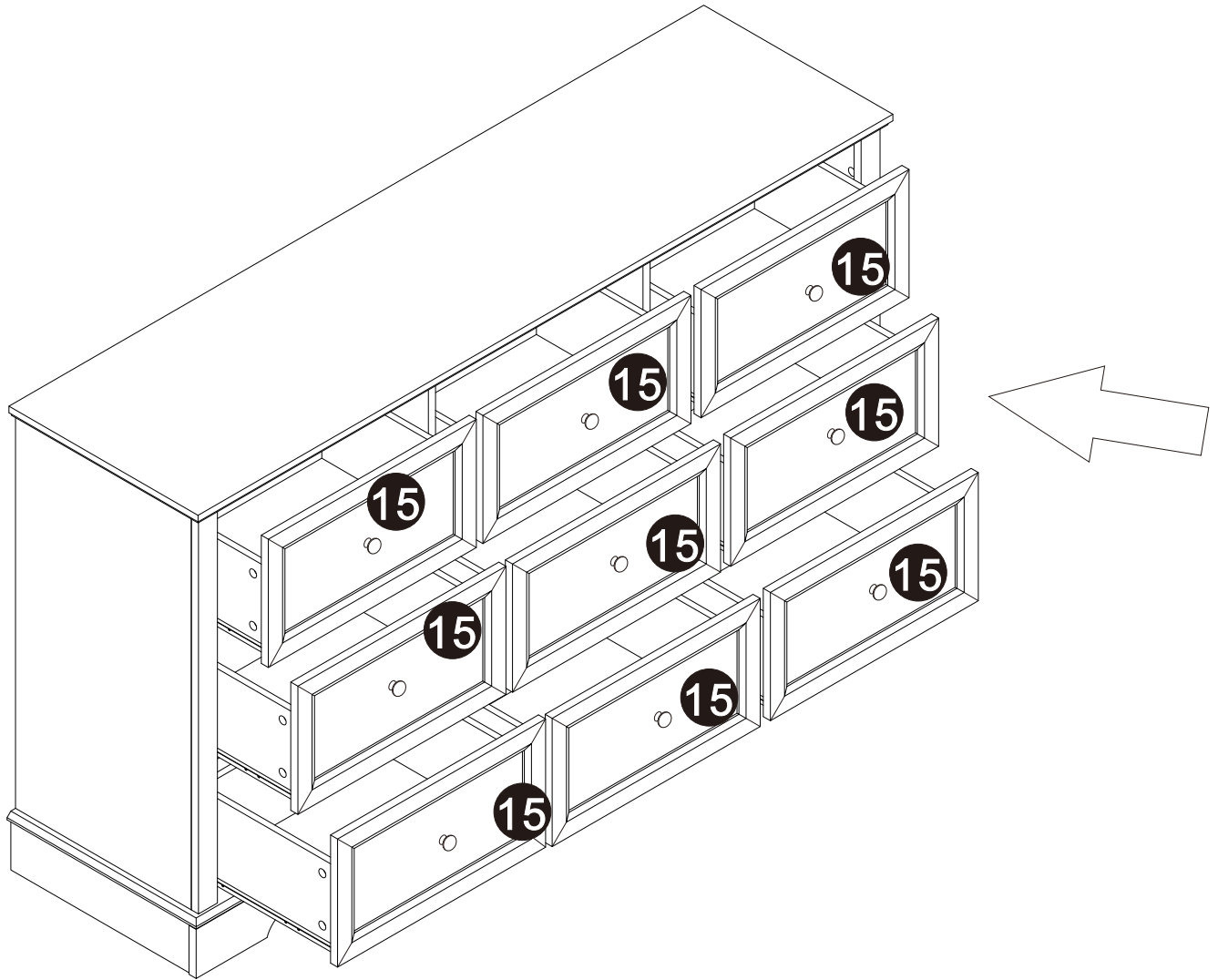

WARRANTY

WARRANTY CLAIMS

- There is a 30-day warranty for broken furniture or any other problems that do not work properly. The warranty will start from the date of purchase which must be verified by proof of purchase.
- Before making a claim, we may be able to answer your query, simply call us. Please leave your purchase order number, along with some details of the problem, if you want a replacement part. We will arrange within 48 hours. If there is out of stock, we will reply with a shipping date.
- The product must be used in accordance with the instructions provided. For health reasons.
- For other reasons, if the furniture needs to be returned, it must be cleaned and dried and operated within 30 days of receipt.

Type of Warranty Claim

- Failure to follow the furniture instructions will invalidate the warranty. Attention please.
- Does not include damage during installation, but includes damage during transportation.

Scope of responsibility

- Shall not bear any responsibility for misuse or user damage and / or loss of parts during the installation of furniture.
- After using, the damage and scratches of the furniture are not covered by the warranty.

The Warranty Relates to All Bought in The Us and Covers The Following Areas

- Sheet parts: 1 month from the date of purchase.
- Electrical parts: 1 month from the date of purchase.