









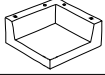
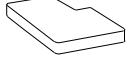

ASSEMBLY INSTRUCTION

Reversible Chaise w/ 2 Pillows

 Legs and hardware are stored in the box, please take out for assembly.

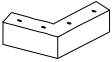
NOTE: Do not use power tools for assembly. Power tools increase the risk of over tightening which lead to splitting or cracking the wood.

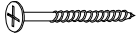
CHAIR COMPONENT LIST

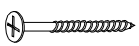
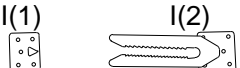
NO	DRAWING	QTY	DESCRIPTION
A		1	SEAT
B		1	SEAT CUSHION
C		2	HEADREST
D-L		1	L LSF BACK CUSHION
D-R		1	R RSF BACK CUSHION
E		8	PLASTIC LEG
F		4	CONNECTOR
G		32	SCREW #4X45MM
X		2	SQUARE PILLOW (DIM 21"x21")
Y		1	OTTOMAN
H		10	SCREW #4X25MM
I		2	ALLIGATOR INSERT

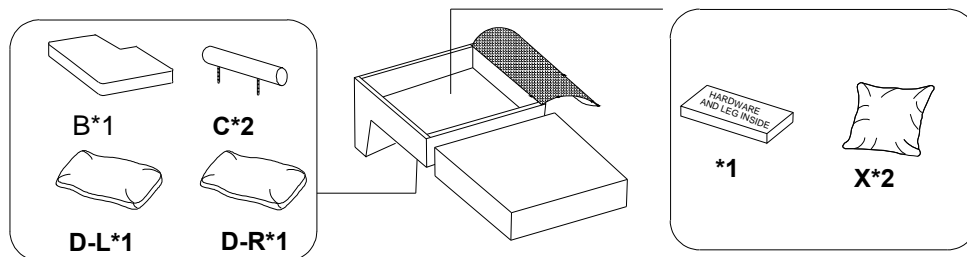

ASSEMBLY INSTRUCTION

Step 1 Align the feet into the white line, insert the screw, and tighten with a screwdriver.

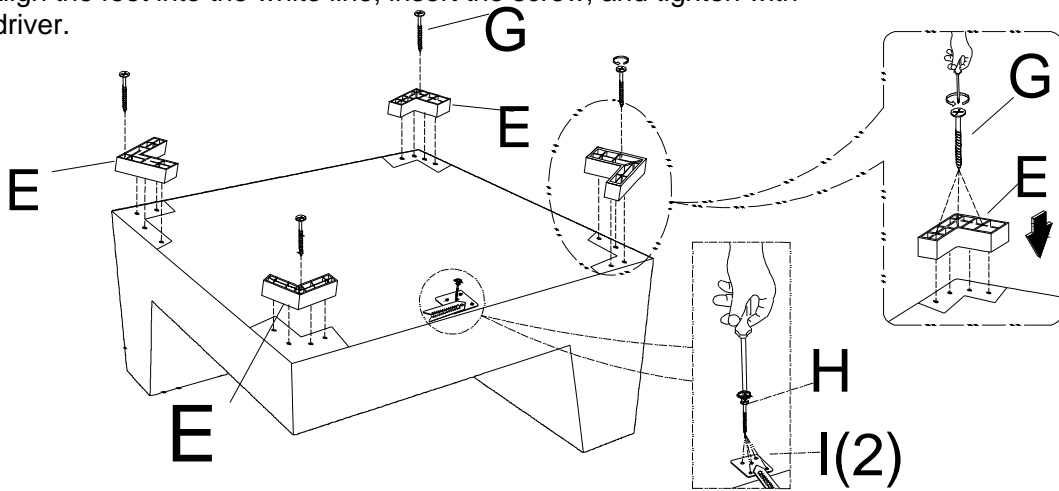

Step 2 Align the feet into the white line, insert the screw, and tighten with a screwdriver.

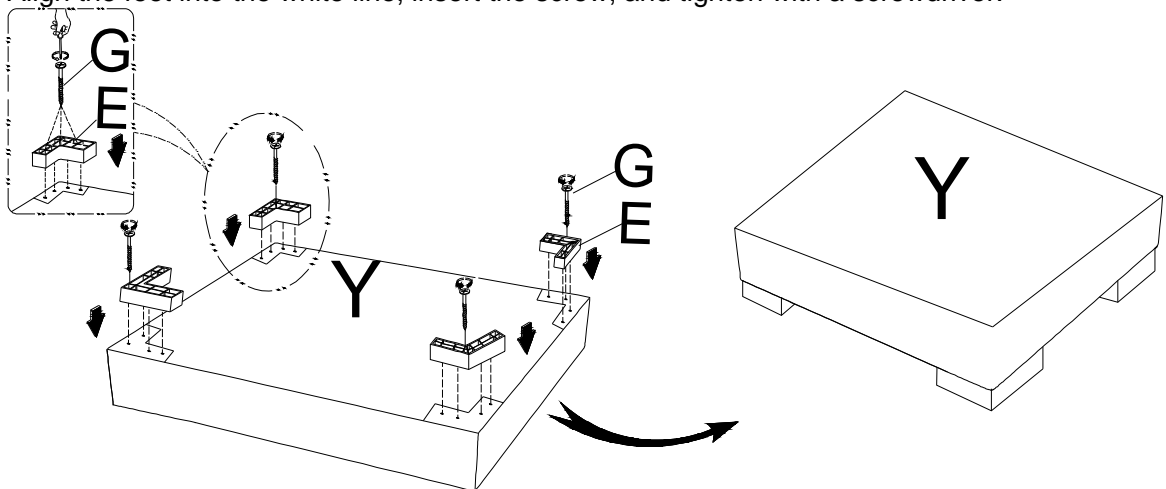

Step 3

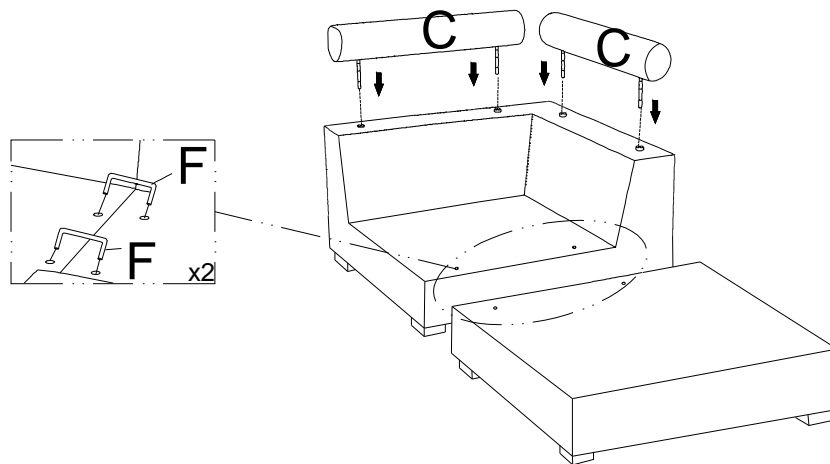

ASSEMBLY INSTRUCTION

Step 4-L

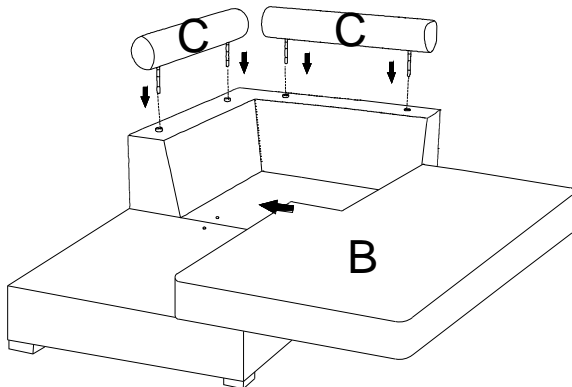

Step 4-R

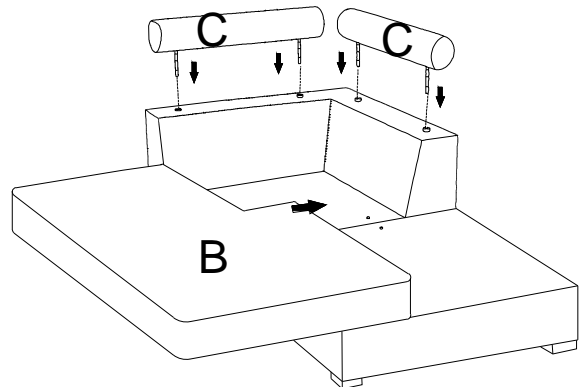

Step 5-L

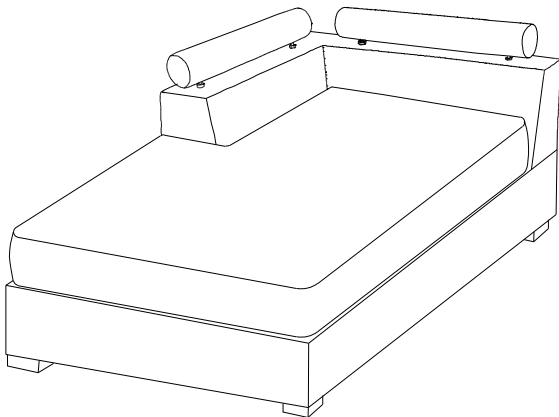

Step 5-R

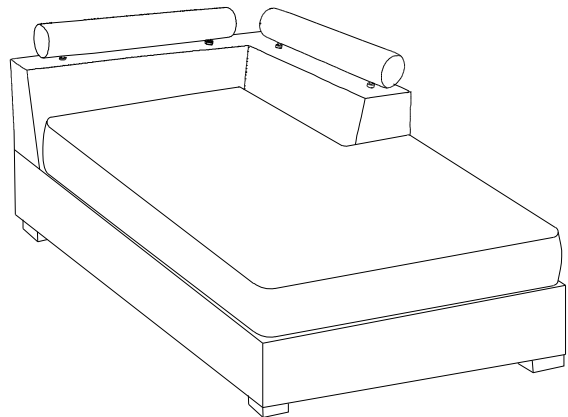

Step 6-L

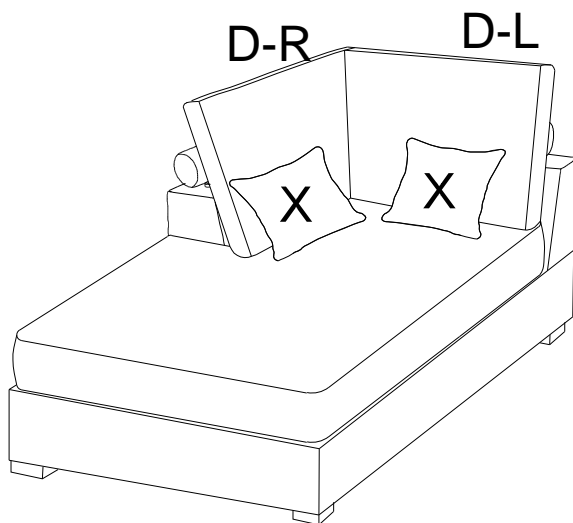

Step 6-R

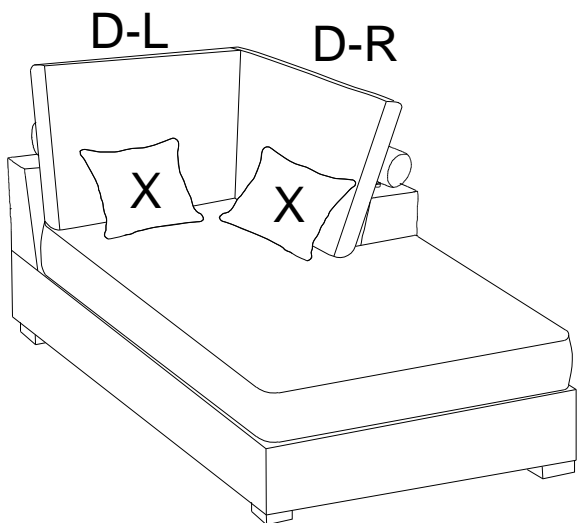

ASSEMBLY INSTRUCTION

STEP 1-R

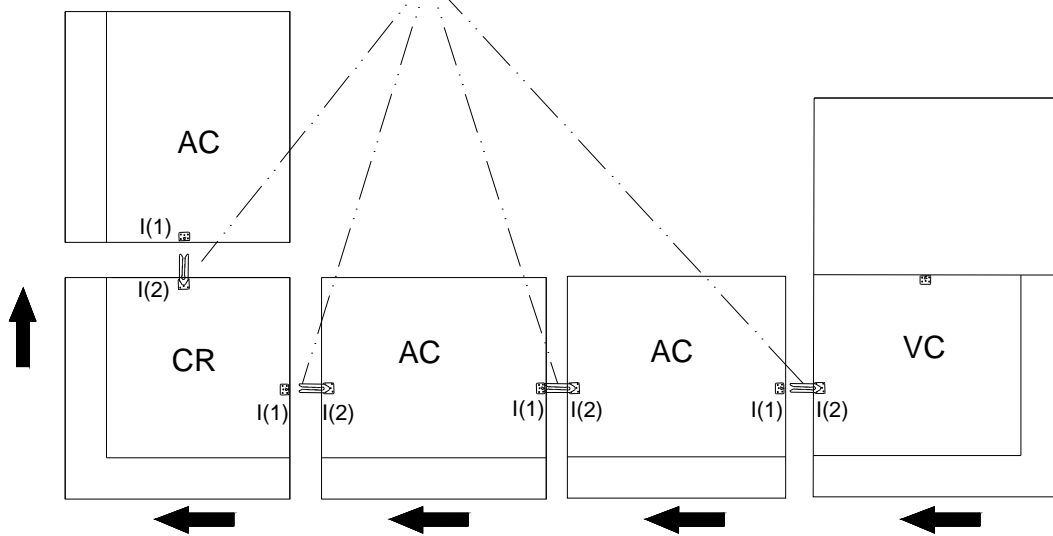
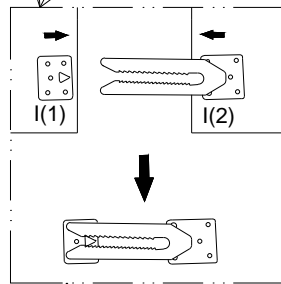
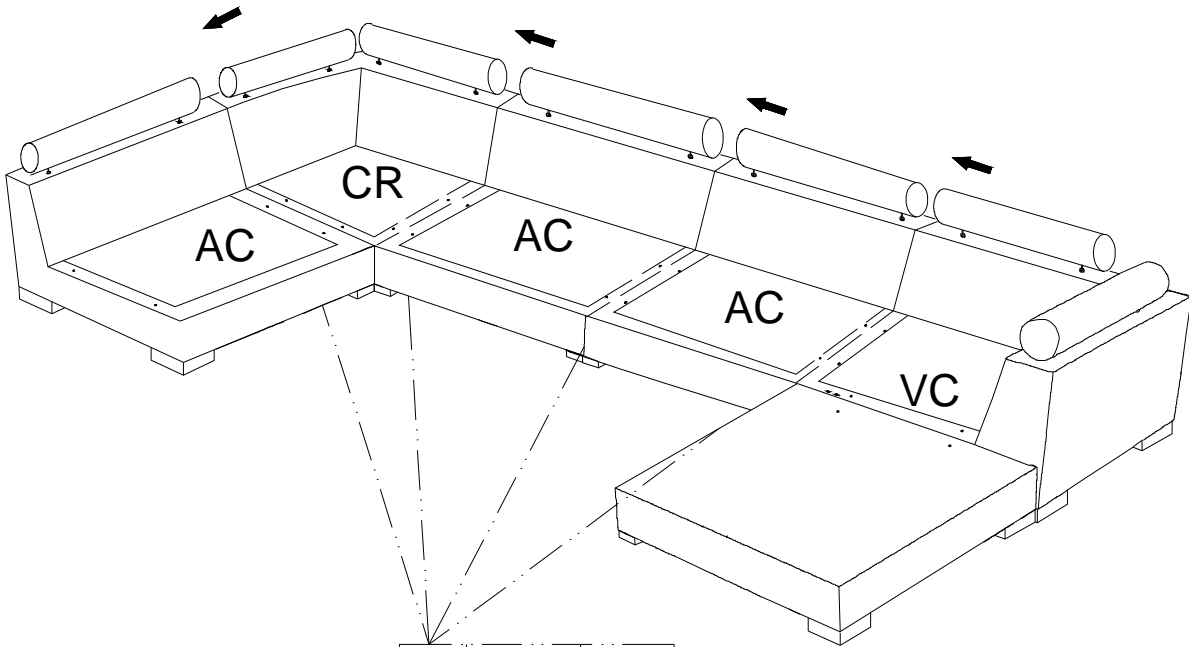

BOTTOM VIEW

ASSEMBLY INSTRUCTION

STEP 1-L

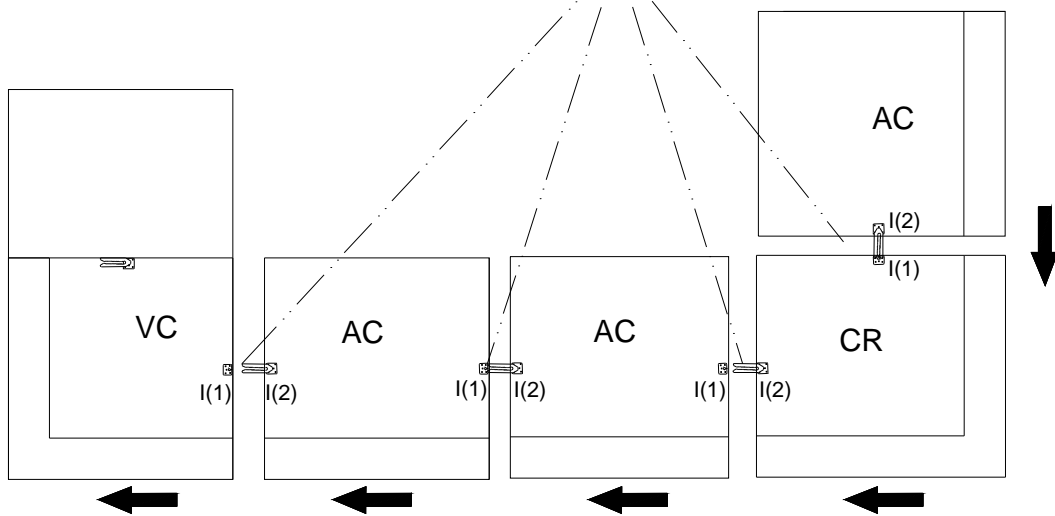
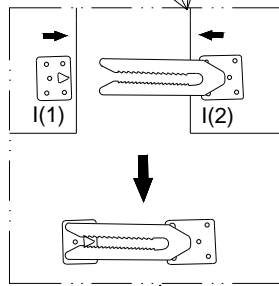
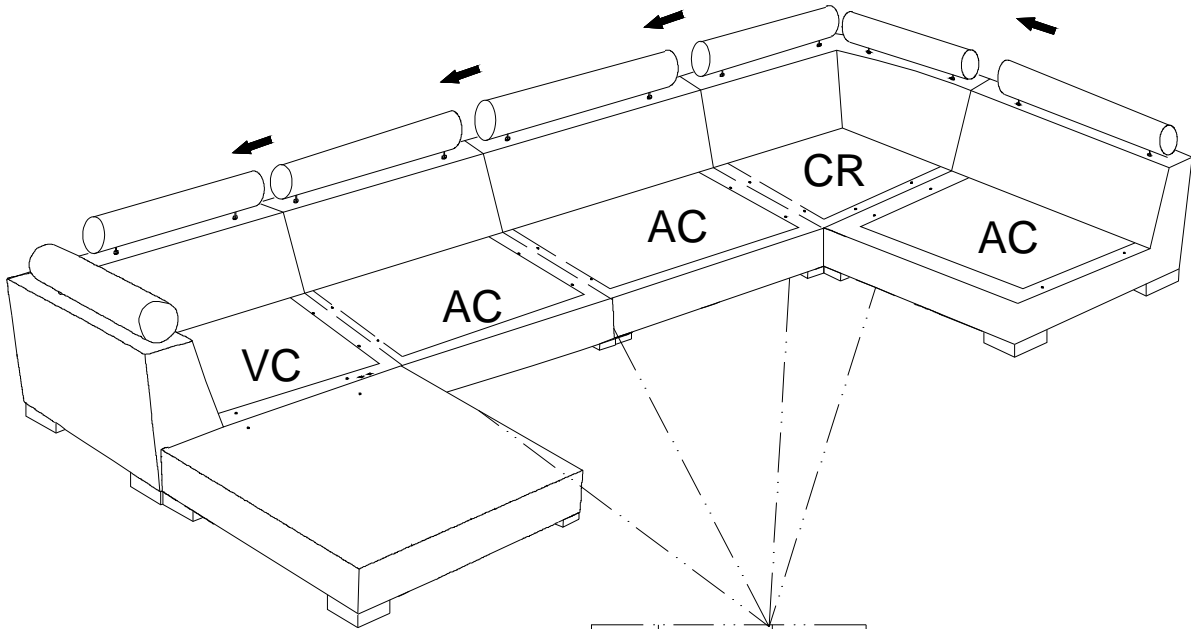

BOTTOM VIEW

ASSEMBLY INSTRUCTION

STEP 2

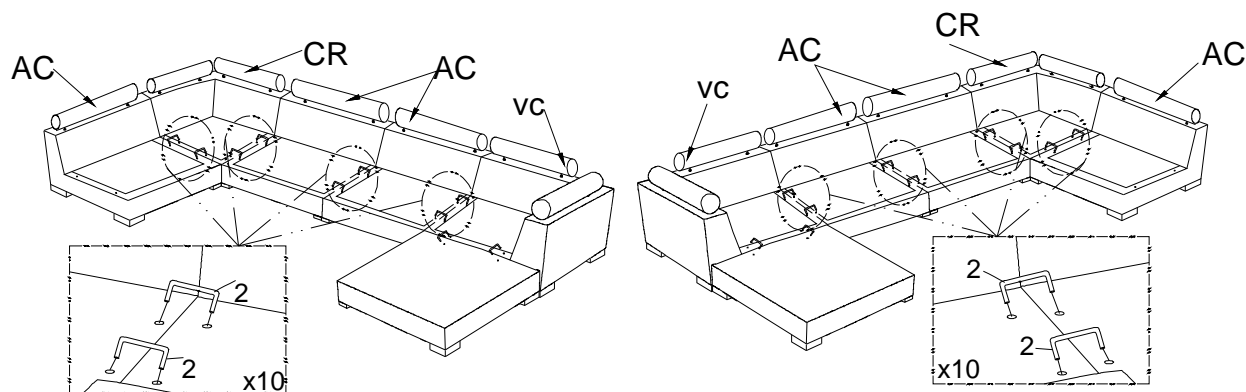

STEP 3

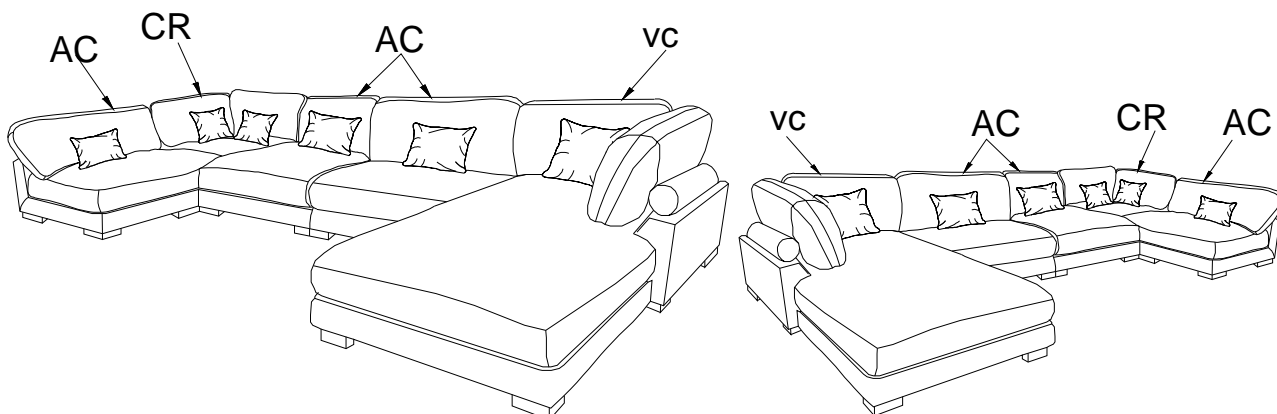

Care Instruction for Corduroy Furniture:

In order to maintain the original appearance of your Corduroy furniture, please follow below simple care procedures:

Avoid exposing furniture directly to sunlight or heating and air conditioning outlets. Sunlight and or exposure to heating and air conditioning outlets will fade/damage Corduroy.

Vacuum or wipe with a soft cloth to remove dust.

Hardware may loosen over time. Periodically check to make sure all connection are tight, Re-tighten if necessary.



For item use on wooden floor, hard surfaces or carpets, it is recommended to install protective pads under all legs and supports to avoid/prevent from damages/scratches and discoloration.