

ASSEMBLY INSTRUCTION

ASSEMBLY INSTRUCTION

ASSEMBLY TIPS:

- 1.Remove hardware from box and sort by size.
- 2.Please check to see that all hardware and parts are present prior to start of assembly.
- 3.Please follow attached instructions in the same sequence as numbered to assure fast & easy assembly.



Warning!!



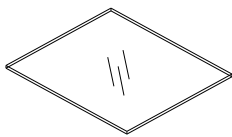
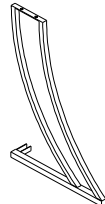
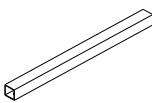
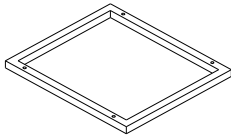
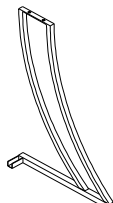

- 1.Don't attempt to repair or modify parts that are broken or defective.Please contact the store immediately.
- 2.This product is for home use only and not intended for commercial establishment.

ASSEMBLY TIME PER UNIT: 20 MINUTES

PARTS IDENTIFICATION

<p>A</p> <p>TOP GLASS  1PC</p> <p>C</p> <p>LEFT FRAME  1PC</p> <p>E</p> <p>CROSSBAR  1PC</p>	<p>B</p> <p>TOP FRAME  1PC</p> <p>D</p> <p>RIGHT FRAME  1PC</p>
--	---

HARDWARE PACKAGE

Z	DESCRIPTION	FIGURE	Q'TY
1	BOLT		8PCS
2	SUCTION CUP		4PCS
3	LEVELER		4PCS
4	ALLEN WRENCH		1PC

STEP 1

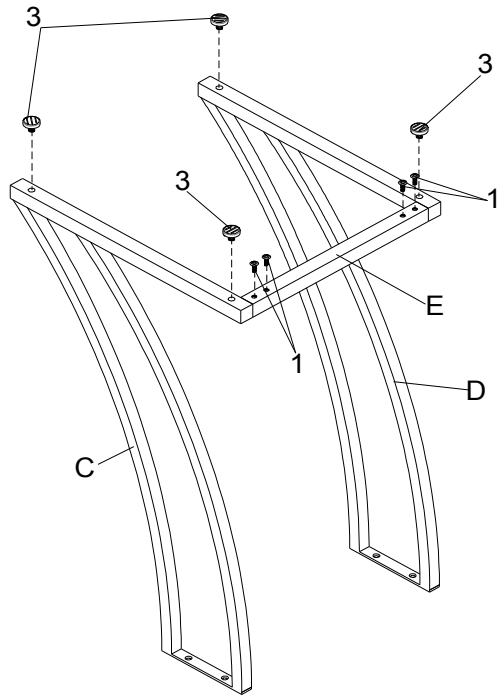

STEP 2

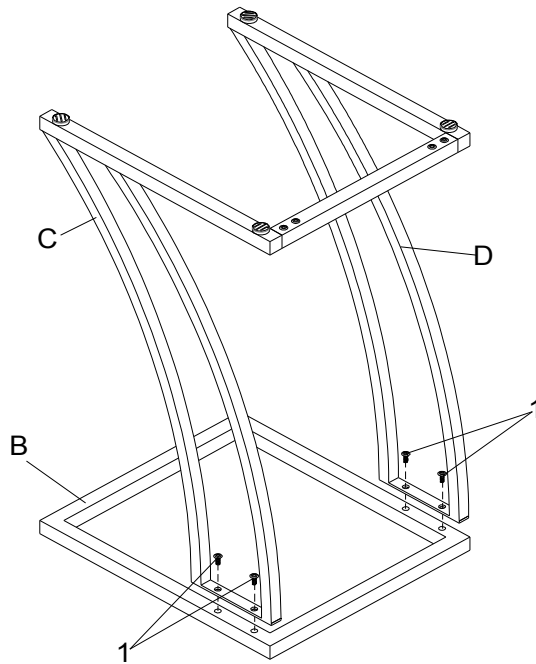

STEP 3

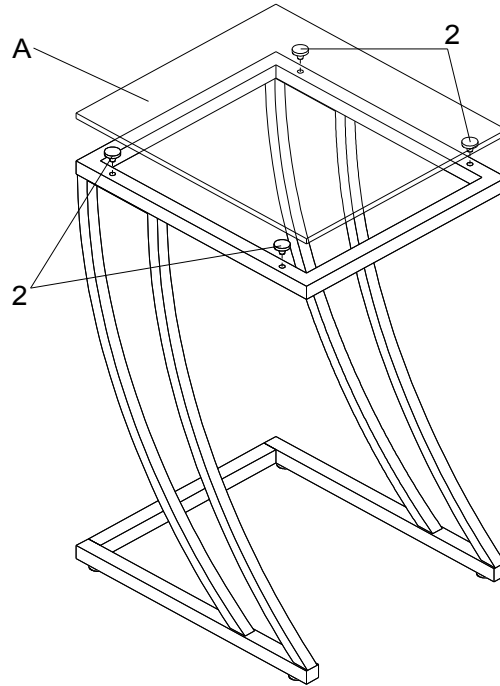

FINISH

