

INSTALLATION INSTRUCTIONS

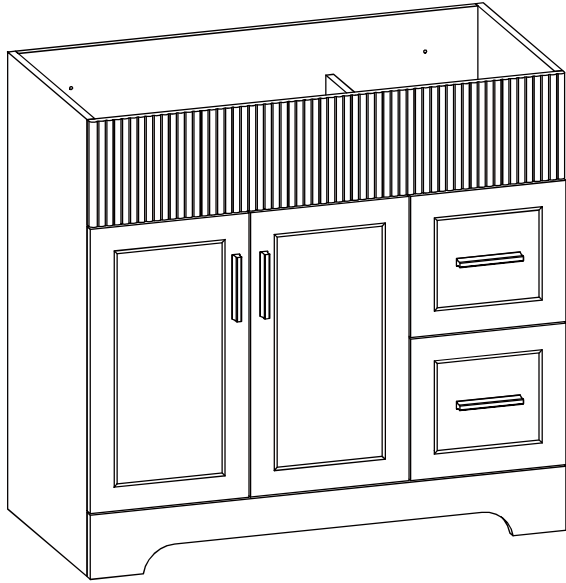

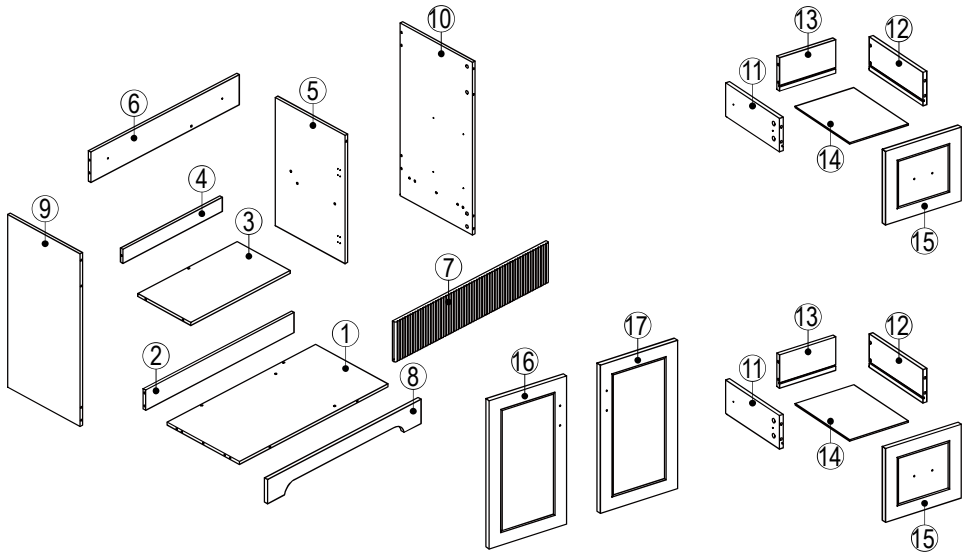























DIMENSIONS



ASSEMBLY DIAGRAM



PARTS LIST

PARTS LIST			HARDWARE LIST		
No.	Description	QTY	No.	Description	QTY
1		1	18	 Three-in-one Connector	53
2		1	19	 Wood Plug	4
3		1	20	 ST4*14 Screws	40
4		1	21	 Slider	4
5		1	22	 Hinges	2
6		1	23	 Hinges	2
7		1	24	 4*20mm Handle	2
8		1		 4*22mm Handle	2
9		1	25	 ST5*60 Screws For Fix On The Wall	2
10		1			
11		2			
12		2			
13		2			
14		2			
15		2			
16		1			
17		1			

CAUTION: Please confirm the parts list before installation

YOU MAY NEED (NOT SUPPLIED)

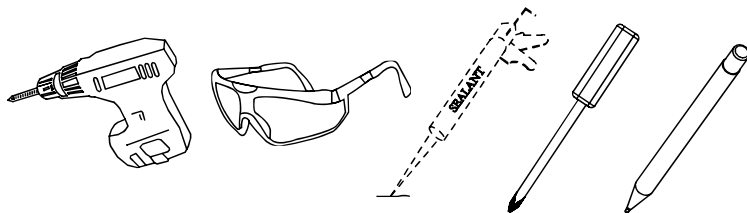

INSTALLATIONS

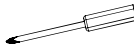

STEP 1

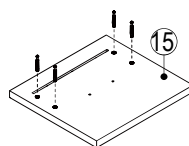
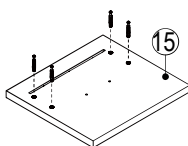
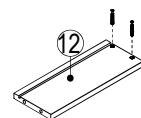
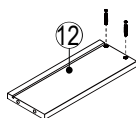
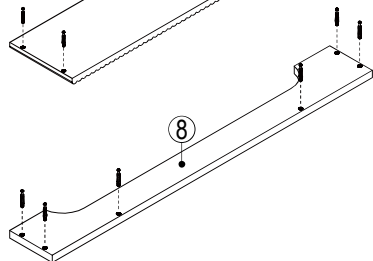
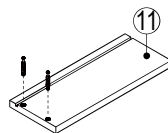
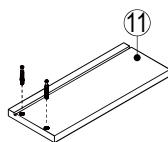
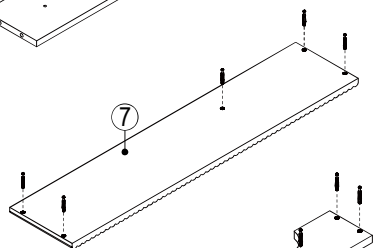
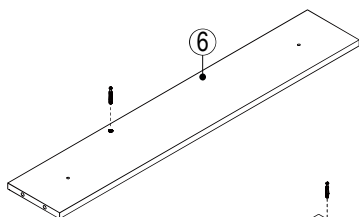
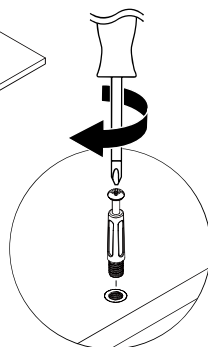
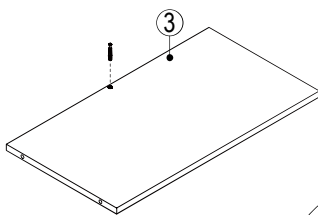
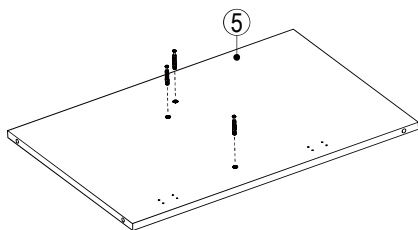
HARDWARE LIST	
18 	32 PCS
	



● Insert the Cam Screw into the shelves above.

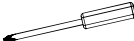

STEP 2

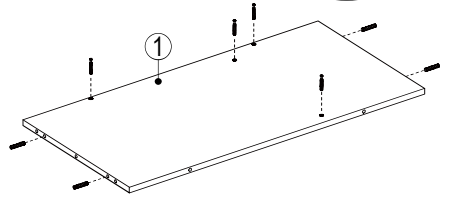
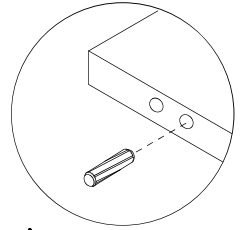
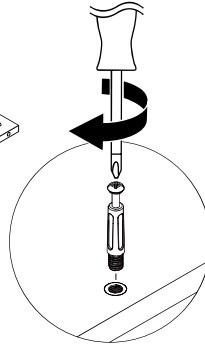
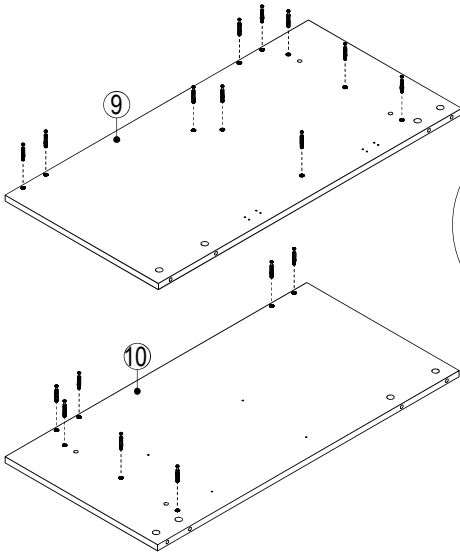
HARDWARE LIST		
18	 21 PCS	
19	 4 PCS	

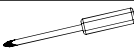

- Insert the wooden dowel pins into the shelves.

STEP 3

HARDWARE LIST		
21	 M 4 PCS	
20	 8 PCS	

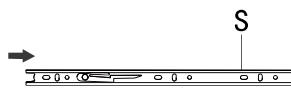
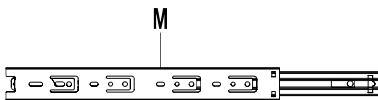
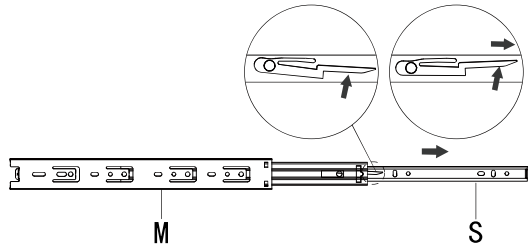

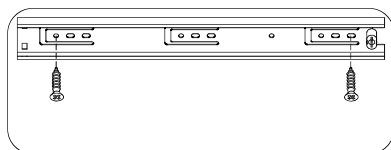
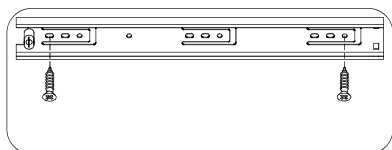
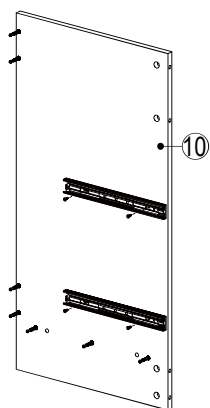
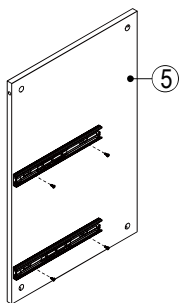

- Keep pressing here, then pull out to devide the slide.





- Refer to the illustration to fix the Slide rails to the board #5 and #10 with screws.

STEP 4

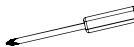
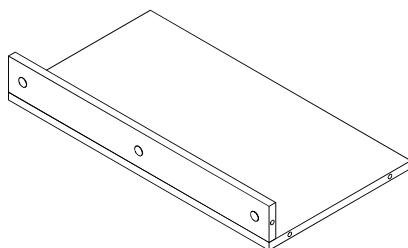
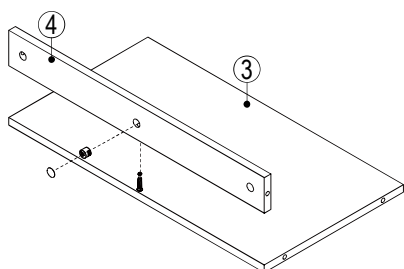
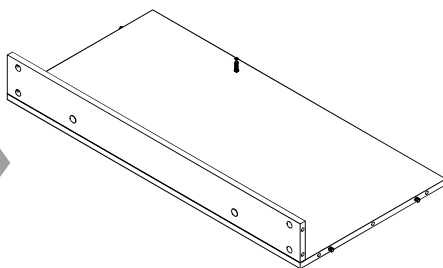
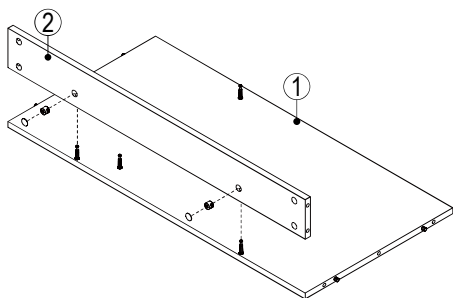
HARDWARE LIST		
18		3 PCS
18		3 PCS



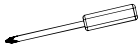

STEP 5

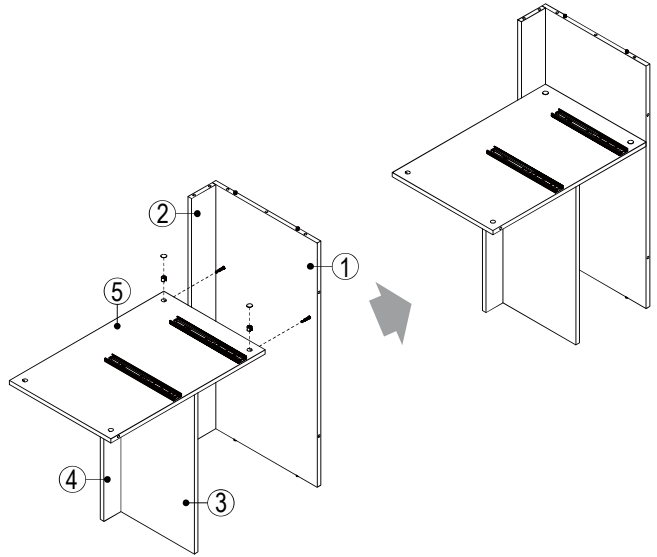
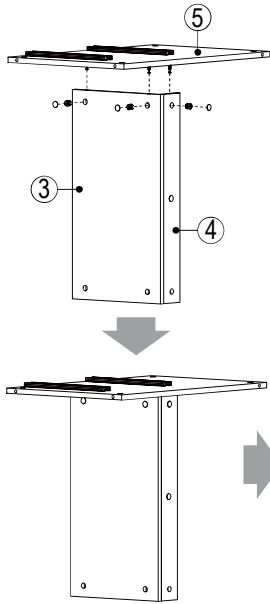
HARDWARE LIST			
18		5 PCS	
18		5 PCS	



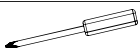

STEP 6

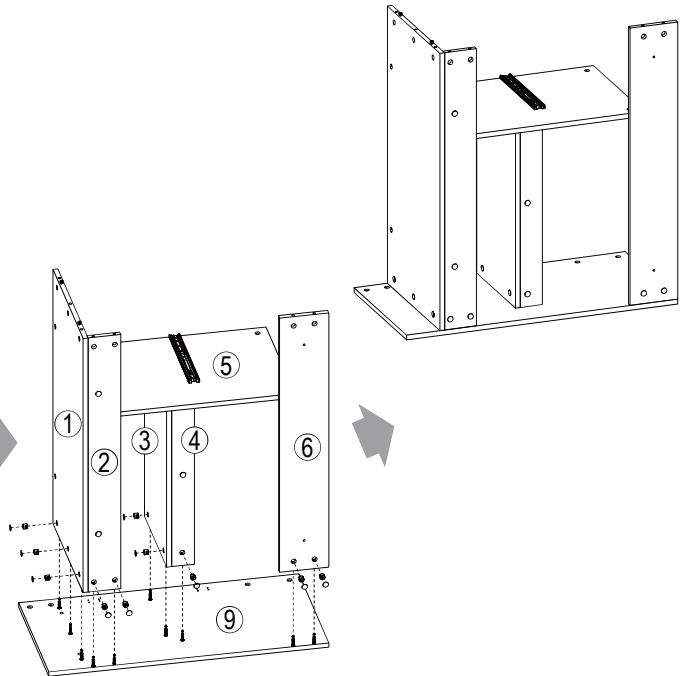
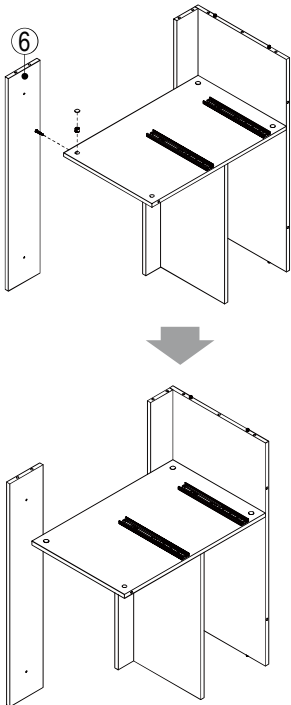
HARDWARE LIST			
18		11 PCS	
18		11 PCS	



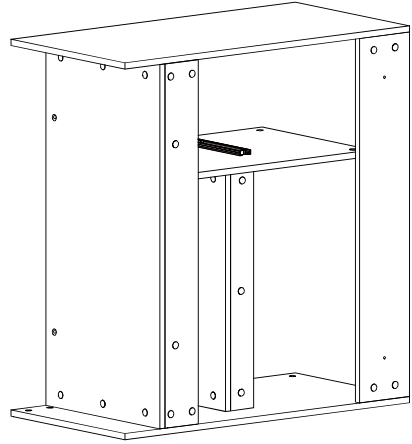
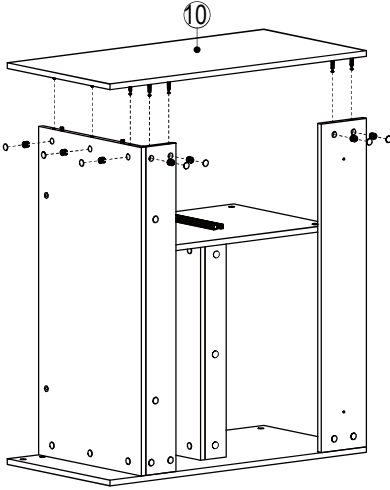
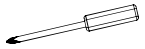

STEP 7

HARDWARE LIST		
18		7 PCS
18		7 PCS



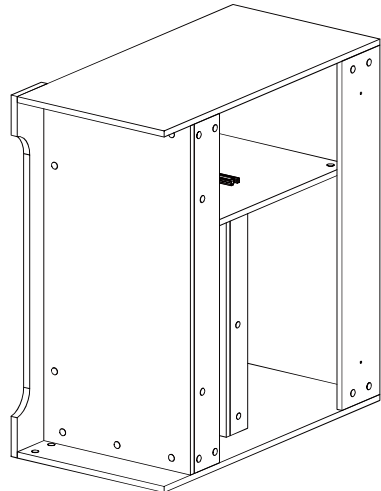
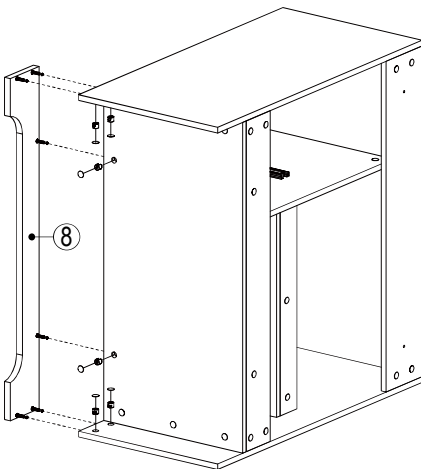
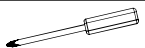

STEP 8

HARDWARE LIST		
18		6 PCS
18		6 PCS





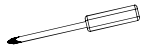
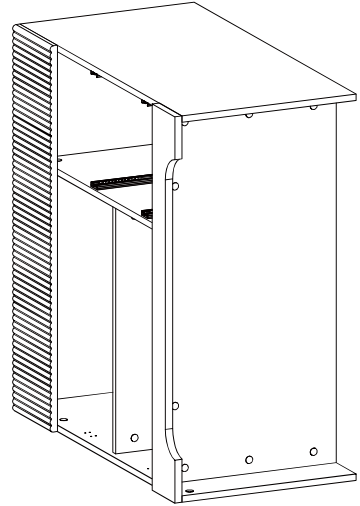
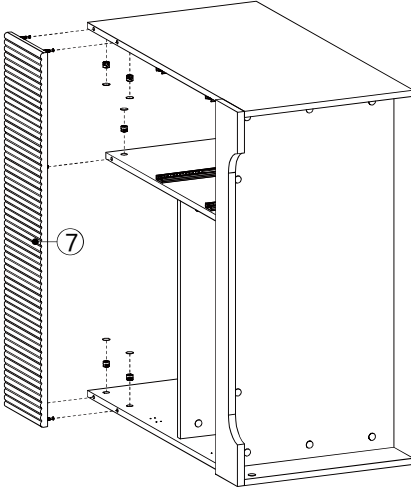

STEP 9

HARDWARE LIST		
18		5 PCS
18		5 PCS



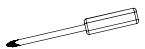

STEP 10

HARDWARE LIST		
20		8PCS
22		2PCS
23		2PCS
24		2PCS
24		4PCS

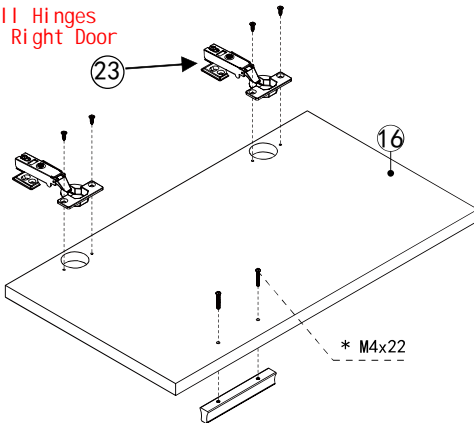

Small Hinges
for Right Door



Large Hinges
for Left Door

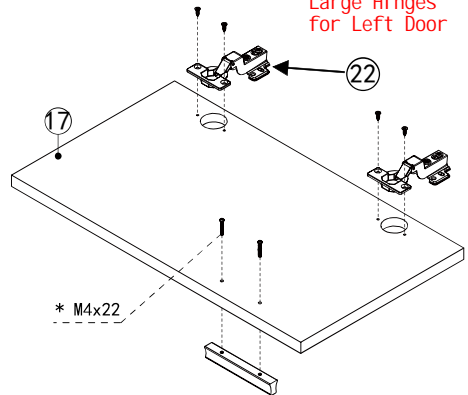

Note: see step 10 to adjust the door's position.

● Use 24 Screws to install the handle and apply 20 Screws to fix the hinge on the shelf #16. Then use 20 Screws to connect the hinge bracket to the cabinet. Repeat these steps for the other door.

STEP 11

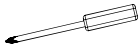

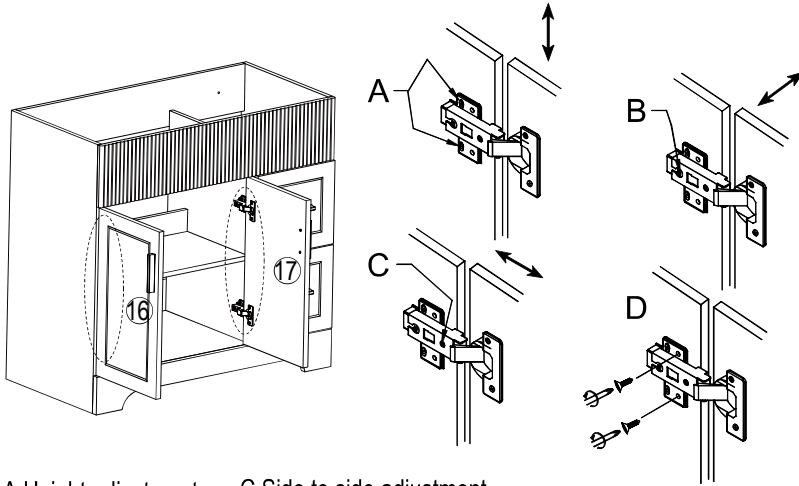
HARDWARE LIST		
20		16 PCS
		



- A.Height adjustment C.Side to side adjustment
B.Depth adjustment D.After adjustment A/B/C,tighten screws.

● To ensure proper cabinet alignment, refer to the above illustrations for instructions about adjusting the cabinet height, depth and lateral movement.

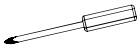

STEP 12

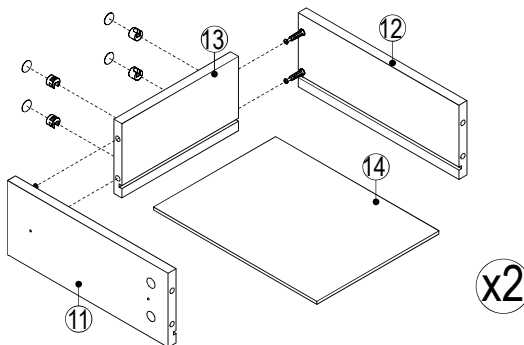
HARDWARE LIST		
18		8 PCS
18		8 PCS
		



- Refer to the illustration, Connect the side plate #11, #12 with the back plate #13 with screws. Then insert the plate #14 in to the finished shelf.

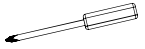

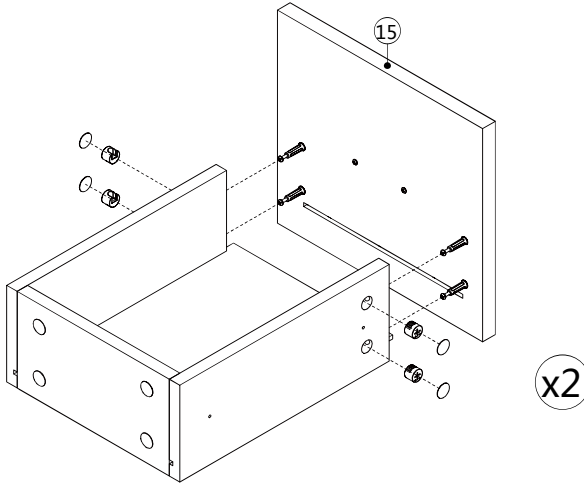

STEP 13

HARDWARE LIST			
⑮		8PCS	
⑮		8PCS	

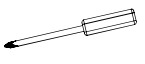

- Refer to the illustration, Draw the panel #15 is inserted into the prepared plate, Then tighten the cam lock with the cover.

STEP 14

HARDWARE LIST			
⑳		8PCS	
㉑		4PCS	
㉒		2PCS	
㉒		4PCS	

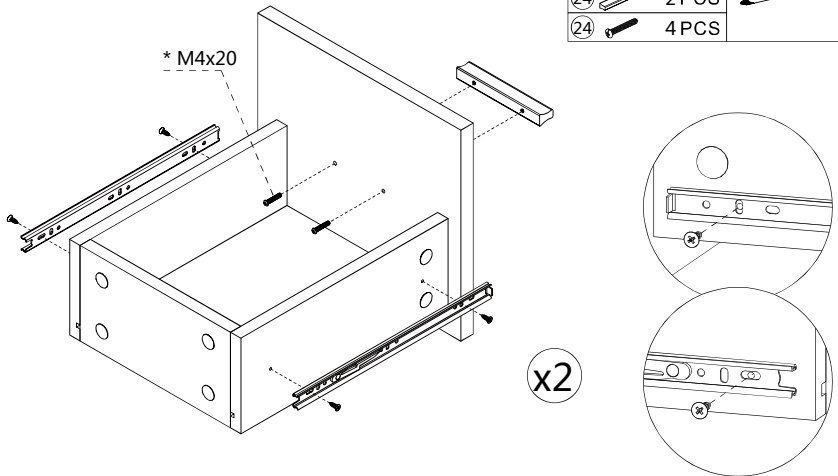

- Refer to the illustration, Apply Screws to fix the slides on the boards #11 , #12. Use ㉒ Screws to install the handle.

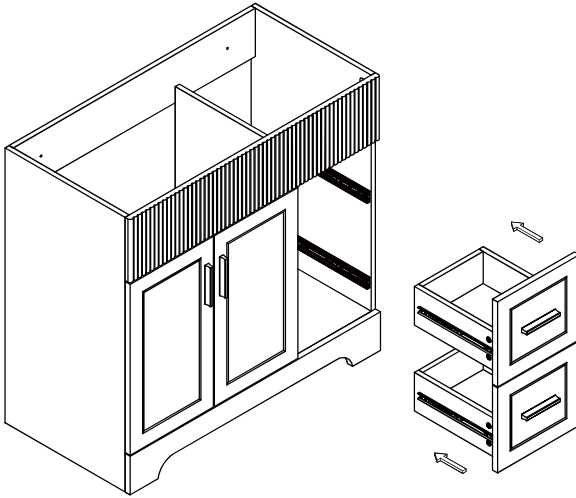

STEP 15

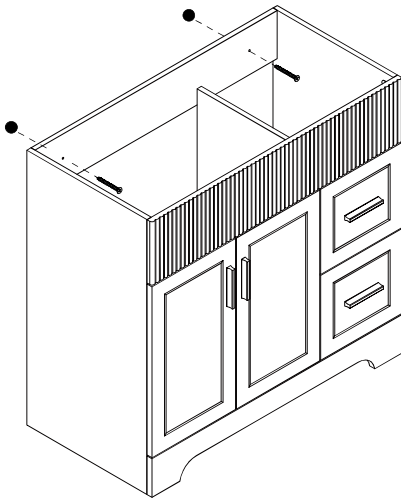

- If the drawers are not in the same level, please adjust the screws in the drawer box.
- Assembled drawers are loaded onto cabinets.

STEP 16



HARDWARE LIST		
25		2PCS
25		2PCS

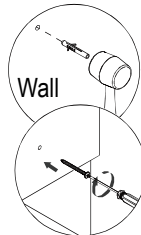
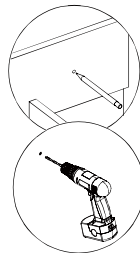
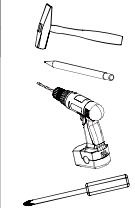

- Refer to the illustration, Draw the spacing between the walls on the cabinet, punch holes in the wall, and fix the cabinet to the wall with screws.

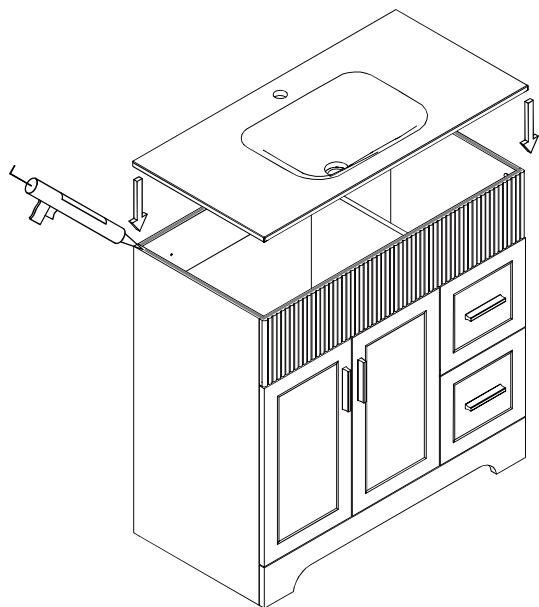
**silicone transparent**

CARE AND CLEANING

1. Many cleansers contain abrasive and chemical substance which is not suitable for cleaning stainless steel, enamel, plating or plastic products. You may use mild cleansers or soaps to clean the surfaces. Wipe any splashes of cleaner solutions from the surface with a clean soft cloth.
2. Maintain ventilation in the bathroom and separate the dry area from the damp one if conditions permit. Try to open the door and windows of the bathroom to maintain adequate ventilation.
3. This cabinet is built to withstand normal bathroom humidity. For best results, keep this vanity dry and take necessary steps to minimize bathroom humidity by opening windows and doors and using the exhaust fan (if available).
4. To maintain the cabinet door, clean and wipe the door regularly with a soft cloth. Wipe condensation with a dry, soft cloth. Keep away from high temperatures.
5. Please do not sit, lean or step on the basin cabinet.