

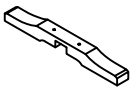

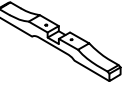

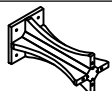

# ASSEMBLY INSTRUCTIONS

Thank you for purchasing this quality product. be sure to check all packaging material carefully for small parts that may have come loose inside the carton during shipment.

Reminder:

1. Use only the hardware supplied
2. Do not over-tighten the bolts.
3. This item may require periodic tightening

Components List : DCQ 14242 Top			
NO.	DESCRIPTION	Q' TY	
A		1pc	Table Top
B		1pc	Pedestal Base
C		1pc	Pedestal Base
Components List : DCQ 14242 Base			
NO.	DESCRIPTION	Q' TY	
D		1pc	Pedestal

Hardware List				
NO.	SKETCH	SIZE	DESCRIPTION	Q' TY
1		4mm	Allen Key	1pc
2		5/16"*3"	Allen Bolts	4pcs
3		5/16"*1-1/8"	Allen Bolts	4pcs
4		8mm	Spring Washer	8pcs
5		8*19*2mm	Flat Washer	8pcs
6			Adjustable Leveler	4pcs

**IMPORTANT NOTE:**

- Please Keep all hardware parts out of the reach of children
- Two or more people are needed for assembly

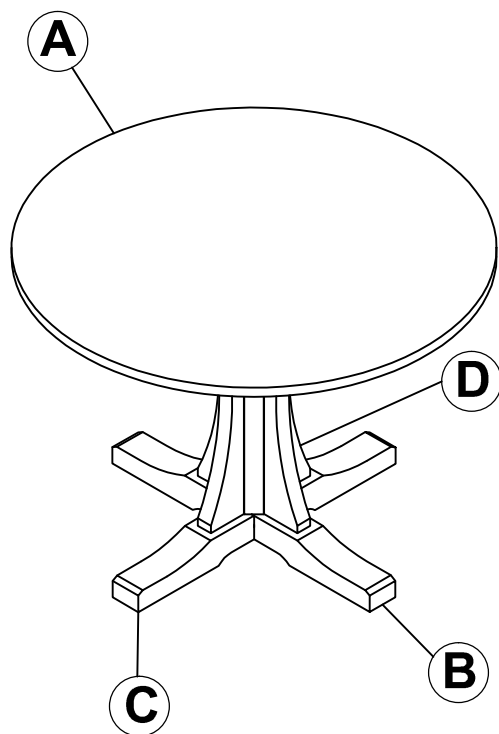

## ASSEMBLY INSTRUCTIONS

**Step 1:** Attach the Pedestal Base (B&C) to the Pedestal (D) using Flat Washer (5). Spring Washer (4). Bolt (2) and tighten with Allen Key (1).

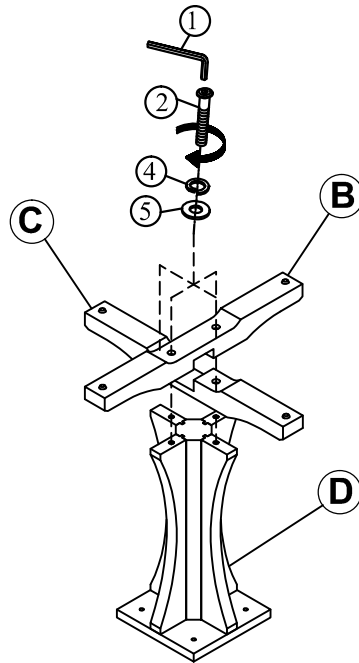

**Step 2:** Turn the Table Top (A) upside down on a soft surface such as a carpet and attach Pedestal (D) to Table Top (A) using Flat Washer (5). Spring Washer (4). Bolt (3) and tighten with Allen Key (1). Turn the table to upright position. Assembly is now complete. Thank you for your purchase.

