

ASSEMBLY INSTRUCTION

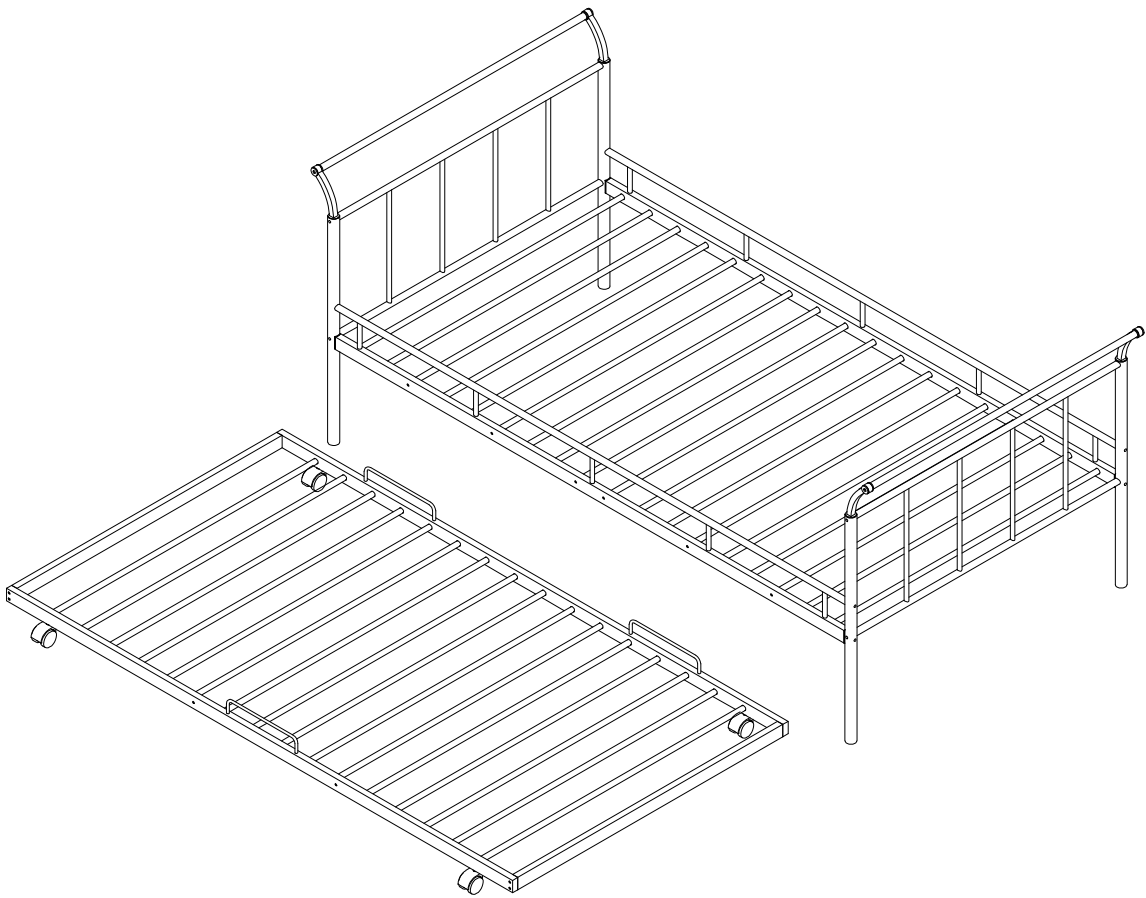

Minimum no. 2 of people
recommended to assemble
this product: Approx.
assembly time: 60 mins

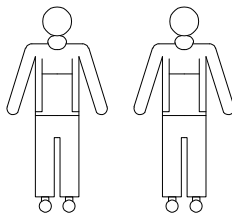

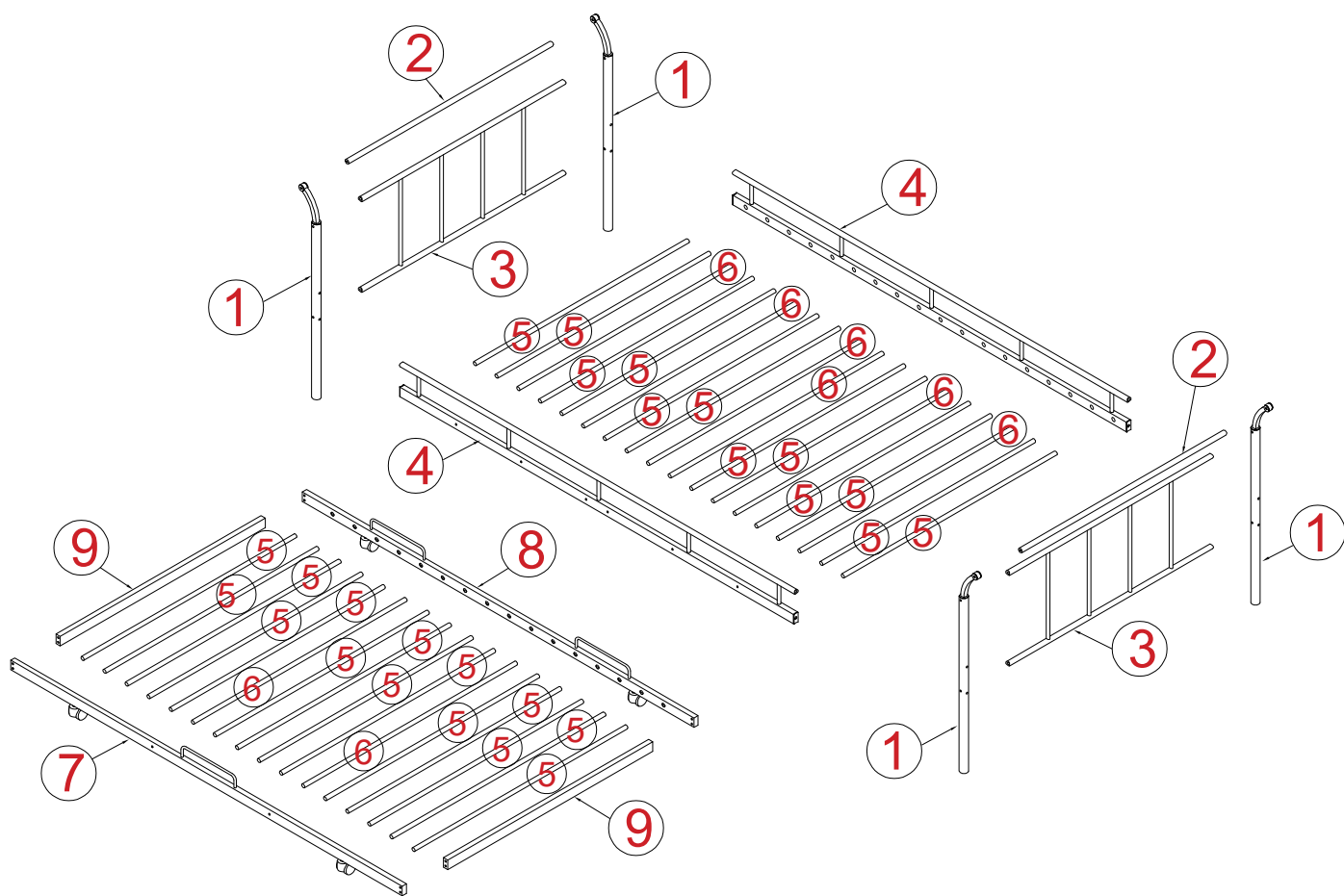



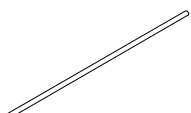
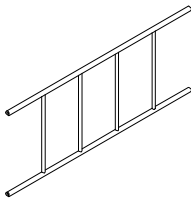
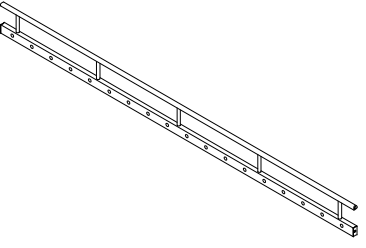
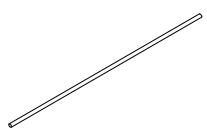
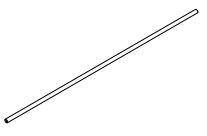
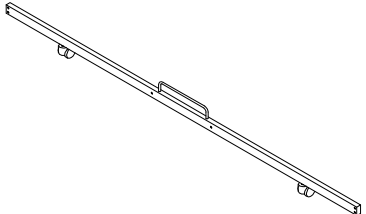
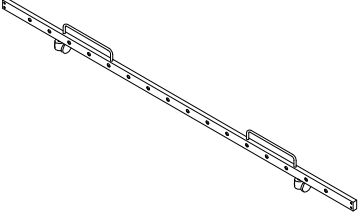
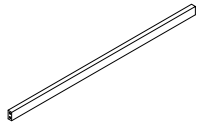



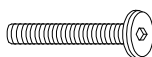

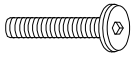
PART LIST



<p>1</p>  <p>4PCS</p>	<p>2</p>  <p>2PCS</p>	<p>3</p>  <p>2PCS</p>
<p>4</p>  <p>2PCS</p>	<p>5</p>  <p>26PCS</p>	<p>6</p>  <p>8PCS</p>
<p>7</p>  <p>1PC</p>	<p>8</p>  <p>1PC</p>	<p>9</p>  <p>2PCS</p>

HARDWARE LIST

<p>A</p>  <p>16PCS M$\frac{1}{4}$"X50</p>	<p>B</p>  <p>4 PCS M$\frac{1}{4}$"X40</p>	<p>C</p>  <p>8 PCS M$\frac{1}{4}$"X35</p>	<p>D</p>  <p>16PCS M$\frac{1}{4}$"X15</p>
<p>E</p>  <p>4PCS Ø32x20</p>	<p>F</p>  <p>1PC M4X23X57</p>	<p>G</p>  <p>M$\frac{5}{16}$"xØ50x70H 2 PCS</p>	<p>H</p>  <p>M$\frac{5}{16}$"xØ50x70H 2 PCS</p>
<p>i</p>  <p>1PC 13mm</p>			

STEP 1

2 SET

A	B	E
		
M $\frac{1}{4}$ x50	M $\frac{1}{4}$ x40	Ø32x20
8 PCS	4 PCS	4 PCS

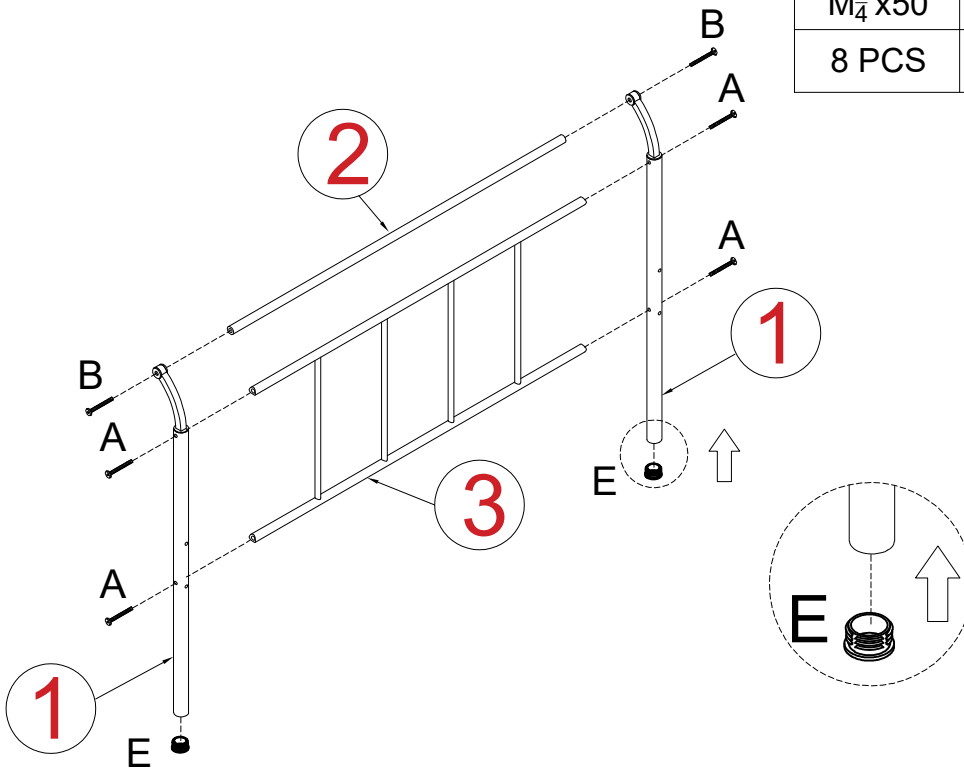

STEP 2

D

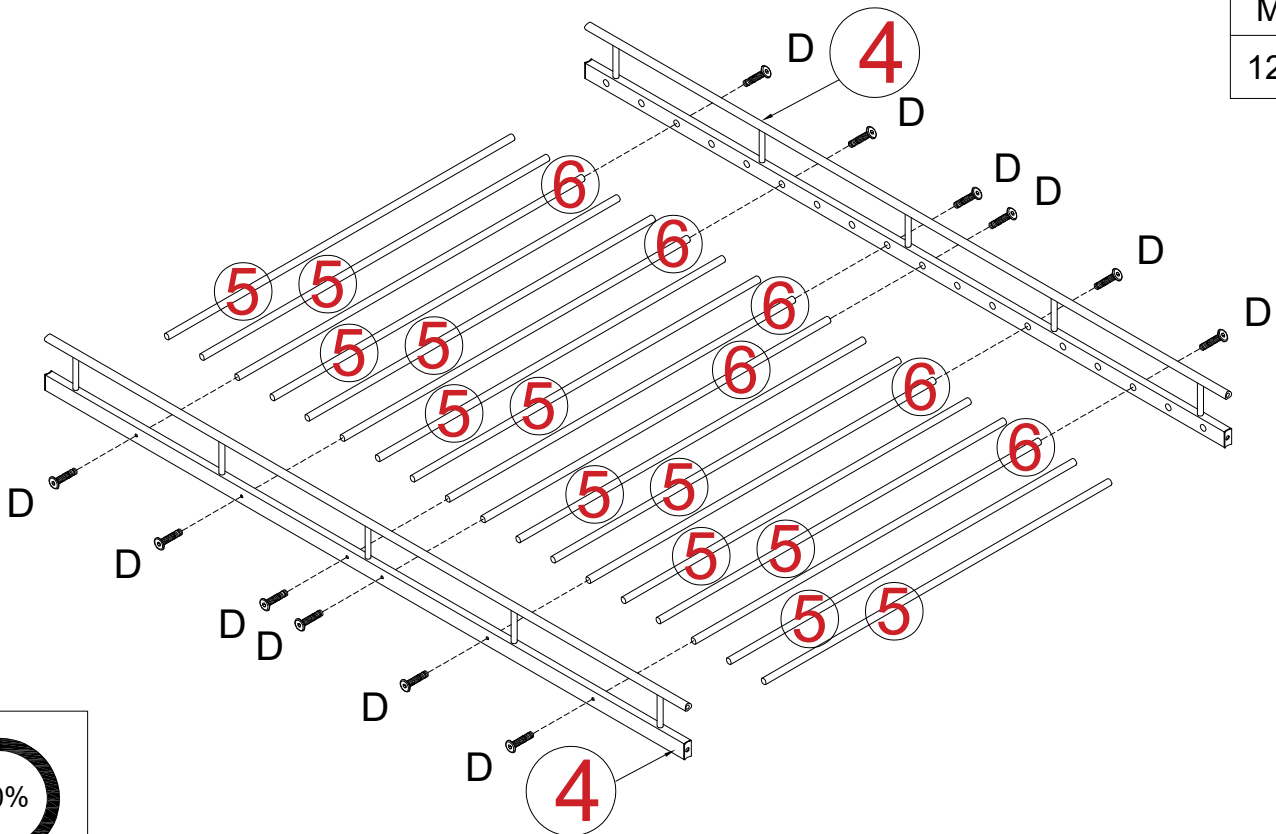
M $\frac{1}{4}$ x15
12 PCS



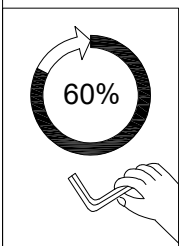
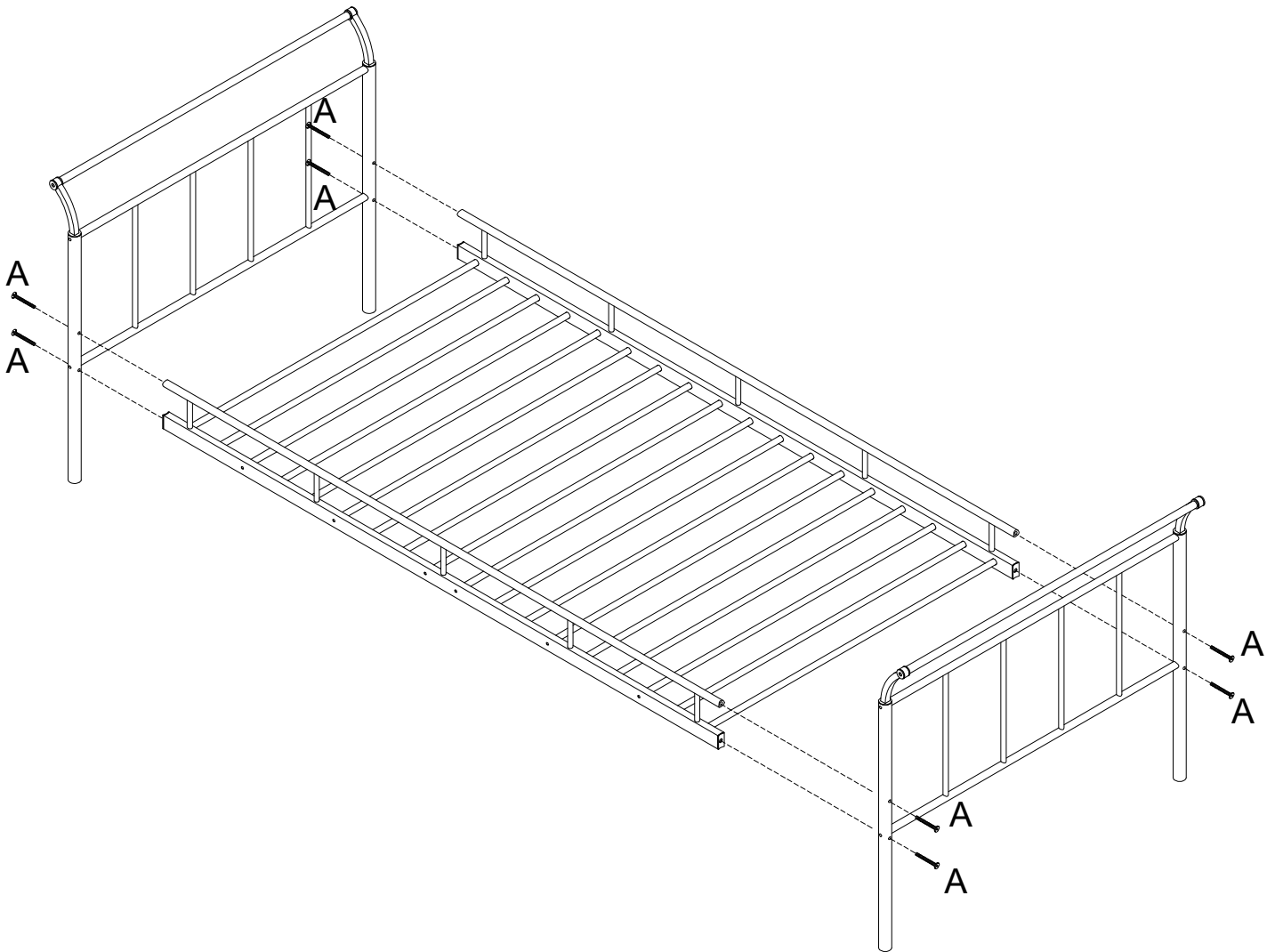

STEP 3

A
 M $\frac{1}{4}$ "x50
8 PCS



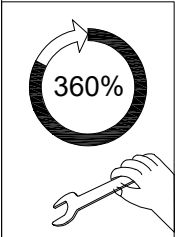
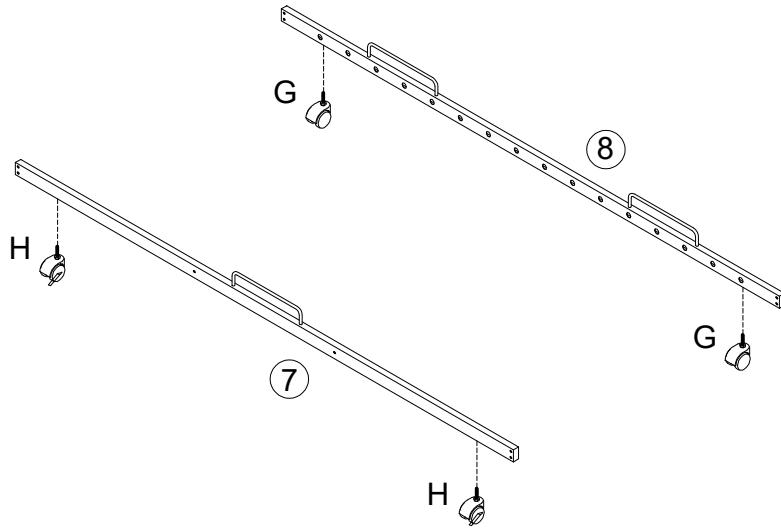

STEP 4

G	H
 M $\frac{5}{16}$ "xØ50x70H	 M $\frac{5}{16}$ "xØ50x70H
2 PCS	2 PCS



STEP 5

C	D
 M $\frac{1}{4}$ "x35	 M $\frac{1}{4}$ "x15
8 PCS	4 PCS

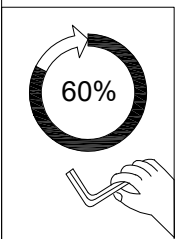
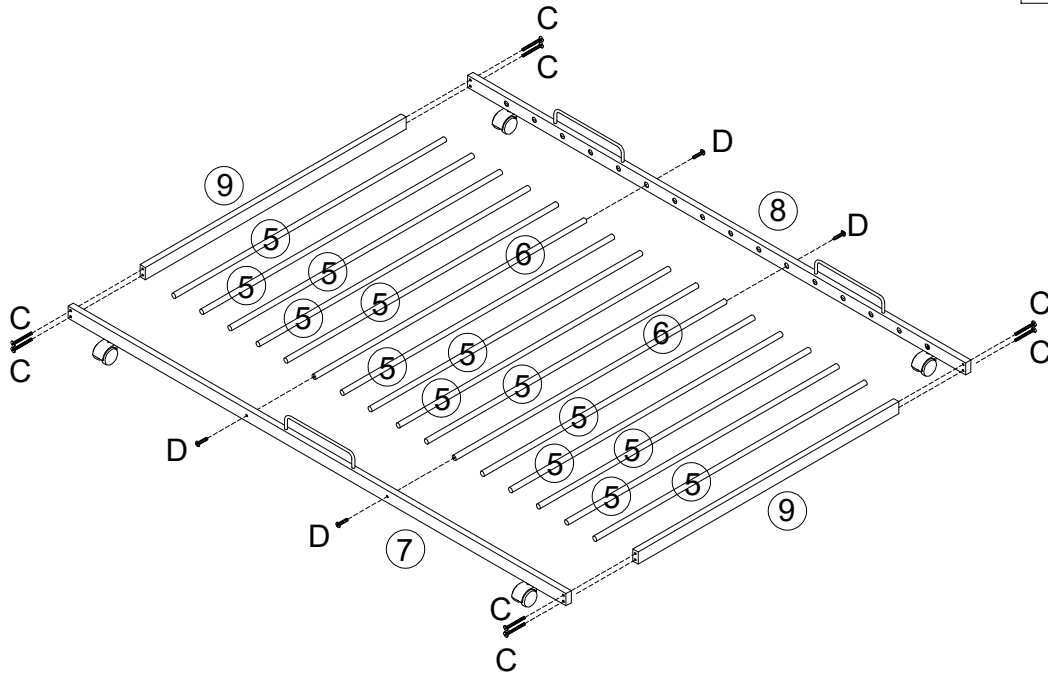

STEP 6

