

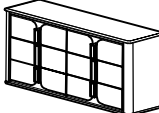



# ASSEMBLY INSTRUCTION FOR ACME FURNITURE

## MODEL#BD03795

Thank you for purchasing this quality product. Be sure to check all packing material carefully for small parts which may have loose inside the carton during shipment. Separate, identify and count all parts and metal hardware. Compare with all parts list to be sure all parts are present. If any part(s) are missing or damaged, please contact your local furniture dealer. For efficient and speedy service, please indicate the model number and code letter of part(s) needed.

\*\*\*Do not fully tighten screw until fully assembled\*\*\*

COMPONENT PARTS			
DESCRIPTION	PART NAME		Q'TY (PCS)
(A)	DRESSER		1
(B)	BUN FOOT		4
(C)	CENTER LEG		1
(D)	JEWELRY BOX		2

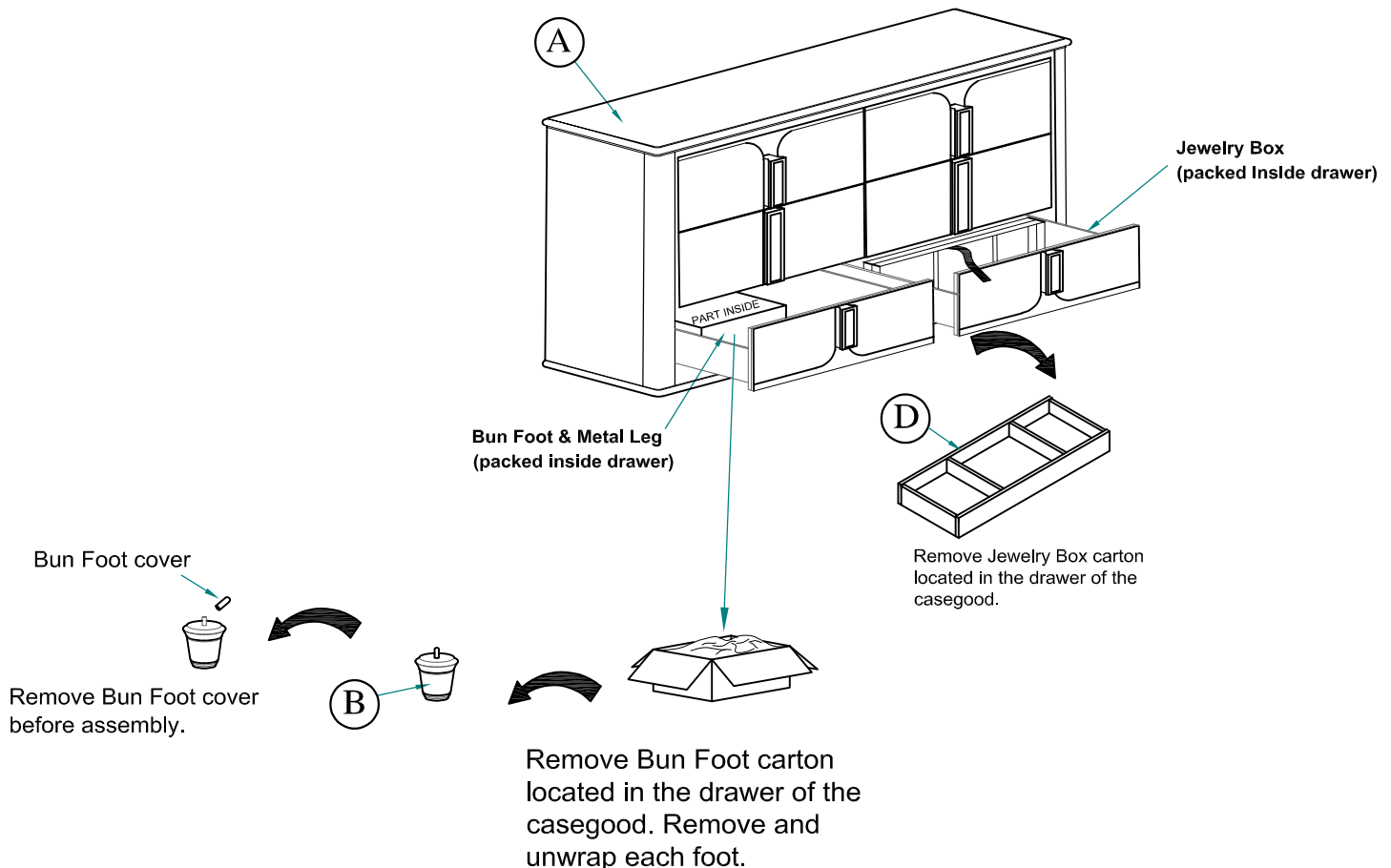

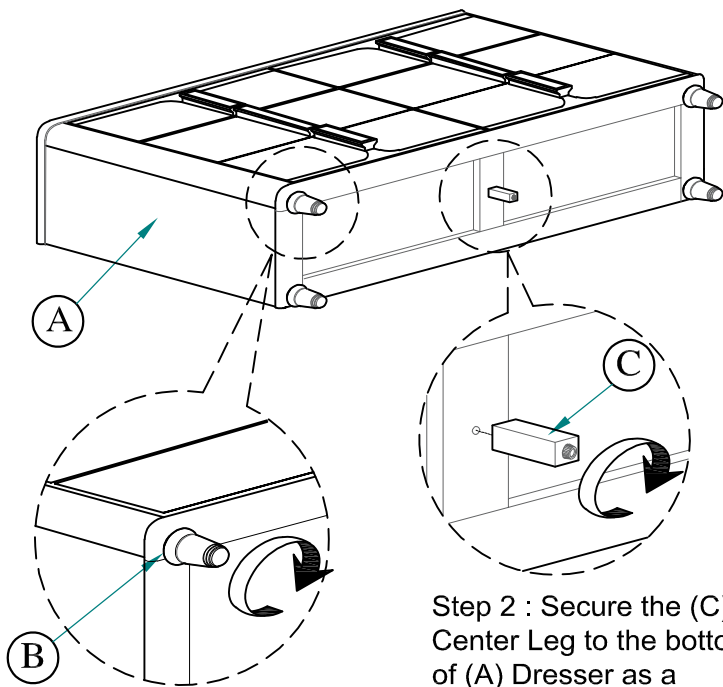



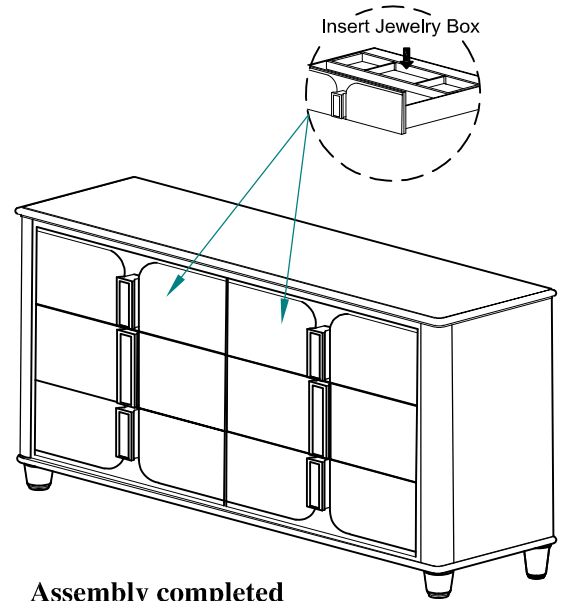

Step 1 : Secure the (B) Bun Foot to the bottom of (A) Dresser as a diagram shown.

Step 2 : Secure the (C) Center Leg to the bottom of (A) Dresser as a diagram shown.



Assembly completed

**HARDWARE LIST (ANTI TIPPING)**

NO	NAME	PART	QTY
A	Bracket		2pcs
B	Tie Wrap		1pc
C	Long Screw		1pc
D	Short Screw		1pc

