











Installation Instruction

Part List and Hardware List

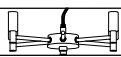
PIECE	PICTURE	DESCRIPTION	QUANTITY
A		Hanging Plate	1X
B		Self-tapping Screw	2X
C		Ceiling plate	1X
D		M4 nut	2X
E		suspender rods	5X
F		canopy	1X
G		Short round tube	1X
H		E12 lamp base canopy	1X
I		canopy	1X

PIECE	PICTURE	DESCRIPTION	QUANTITY
J		lamp body piece	6X
O		Wire connector	3X
P	 black	wire	1X
Q	 white	wire	1X
R	 earth wire	earth wire	1X

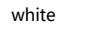
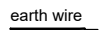
1

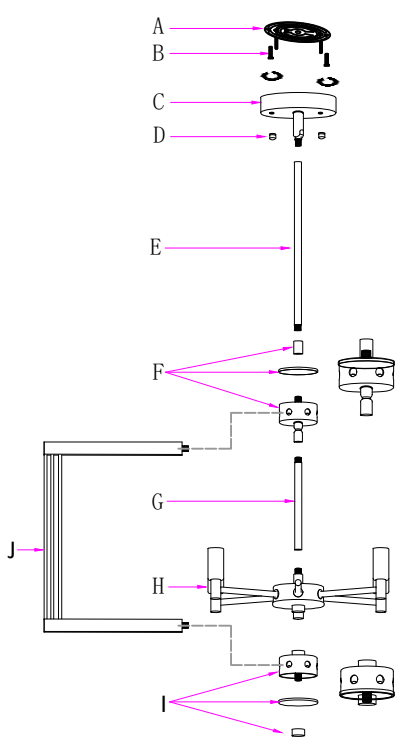

2

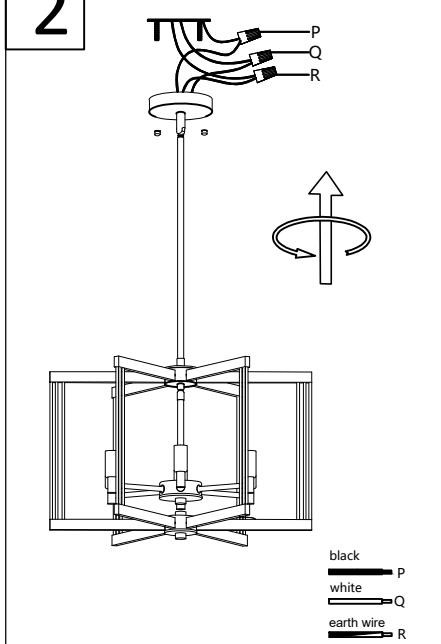

Step 2:
 1. Pass the wires of the lamp body through the H and F rods, and the wires to your home circuit by wire connector (O). (black to black, white to white, earth to earth).
 2. Fix the lamp body to ceiling using the M4 nuts(D).

3

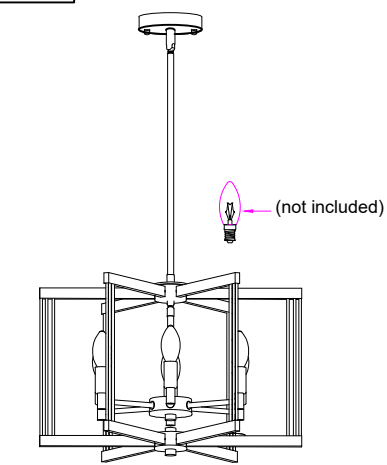

Step 3:
 1. Install the E12 bulb (not included) to complete the installation.

Step 1:

1. Fix hanging plate (A) to ceiling using self-tapping screws (B).
2. Connect E12 lamp base canopy (H) with canopy (F) by short round rod (G)
3. Connect lamp body piece(J) to canopy (F) (I) one by one.
4. Connect canopy (F) and ceiling plate (C) by suspender rods (E) .