

## WIRE CONNECTION DIAGRAM

Wires met safety standards are recommended to connect the supply circuit.

**CAUTION: Risk of fire**

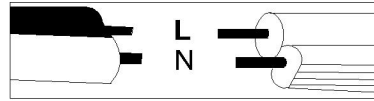

## CANOPY INSTALLATION INSTRUCTIONS

Please read all instructions carefully, Before you proceed to install, make sure that the power supply is turned off and remains off until installation is complete. Please note that each part has been assigned a letter. Please proceed in an alphabetical order.

- |                            |                         |
|----------------------------|-------------------------|
| A. Existing Electrical Box | B. Crossbar             |
| C. Crossbar Screws         | D. Canopy Loop          |
| E. Canopy                  | F. Canopy Loop Nut lock |
| G. Chain                   | H. Ground Wire          |
| I. Loop                    | J. Wire                 |
| K. Junction Caps           |                         |

Attach the crossbar (B) to the existing electrical box (A) using the two crossbar screws (C) which are not supplied and should already be in your box.

Slide the canopy loop nut lock (F) back up over the canopy loop (D), pass the canopy loop (D) through canopy (E), connect with the threaded underside of the crossbar.

Pass the main wire (J) and ground wire (H) through the loop (I), the chain (G), the canopy loop nut lock (F), the canopy (E), the canopy loop (D) and the crossbar (B) until the end of the main wire (J) reaches the electrical box (A) where you can make the appropriate connections. When connecting the wire use electrician approved junction caps (K). Stow the excess wire in the electrical box (A). Raise the canopy (E) and canopy loop nut lock (F), attach canopy (E) to ceiling, slide canopy loop nut lock (F) over canopy loop (D) and hold the canopy (E).

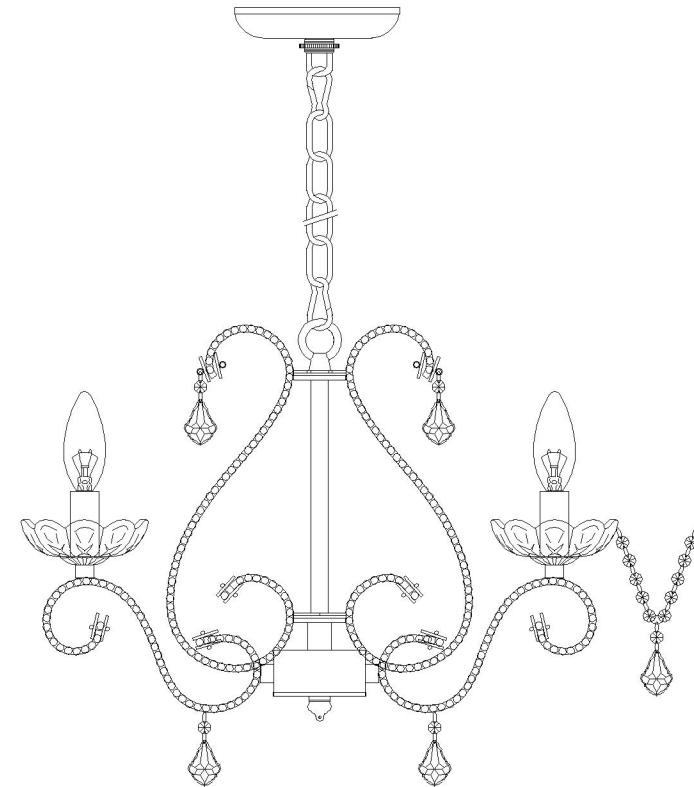
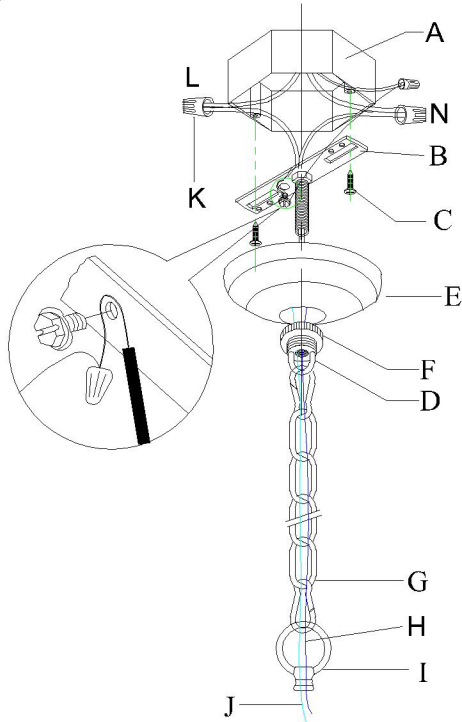

**Light Bulb (Not included)**

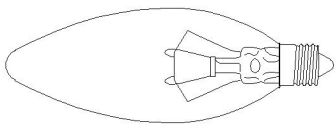

E12

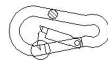

Buckle is used to connect the chain and loop or adjust the length of chain.

**( Rated 110-130V/60Hz, bulb 40W-60W maximum.)**

# Assembly and Installation Steps

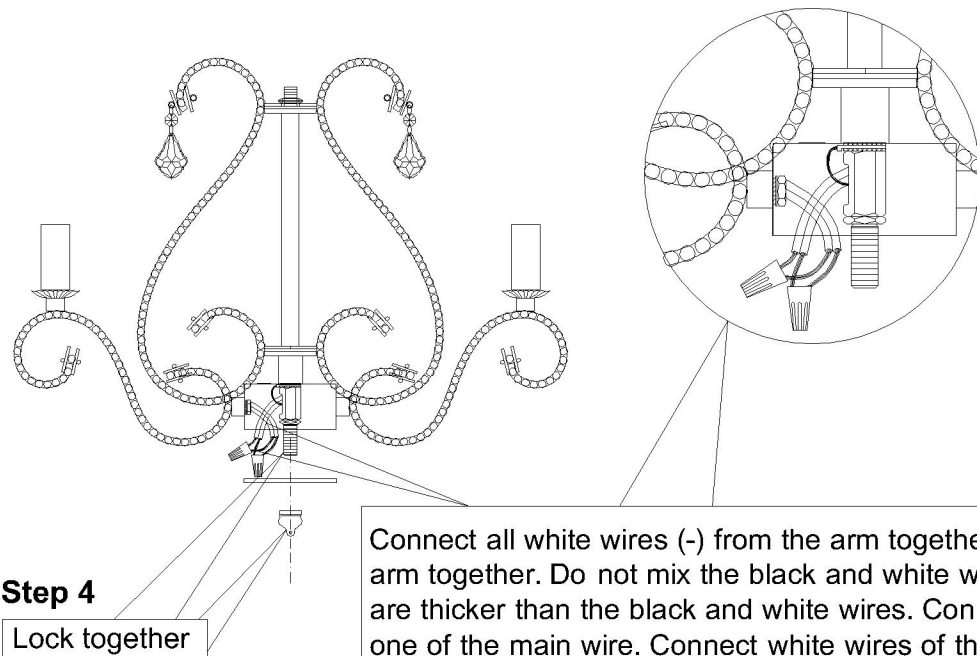
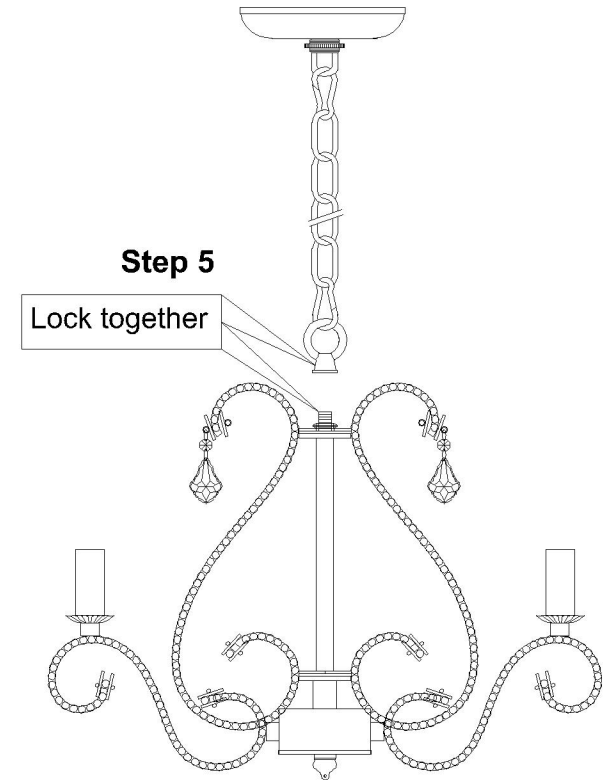
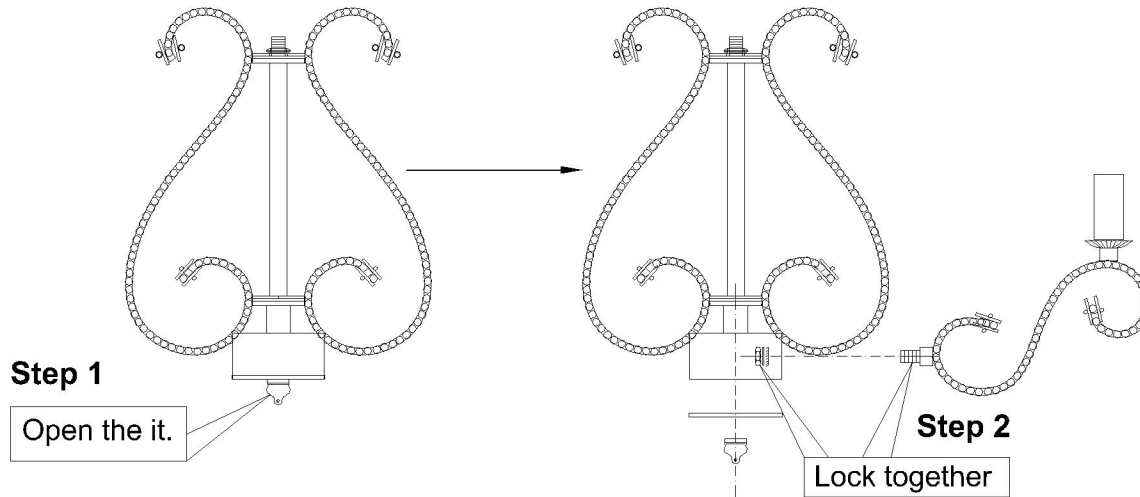

## Step 3

Connect all white wires (-) from the arm together, and connect all black wires (+) from the arm together. Do not mix the black and white wires. There are two same main wires, they are thicker than the black and white wires. Connect black wires of the arms together with one of the main wire. Connect white wires of the arms together with the other main wire. The wires connection is finished.

# Assembly and Installation Steps

## Step 6

1. Lock the crossbar to the junction box of the ceiling by using 2 pcs of 5/32 screws in the accessories bag.
2. Connect the wires. The hot/positive (+) wire is the one which has writing on it. The negative (-) wire is the one which has no writing.
3. Cover the ceiling canopy and attach the screws to the canopy.

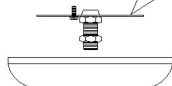

## Step 7

Put it down



## Step 9

Install 5 E12 bulbs  
(Not included).

## Step 8

Lock together

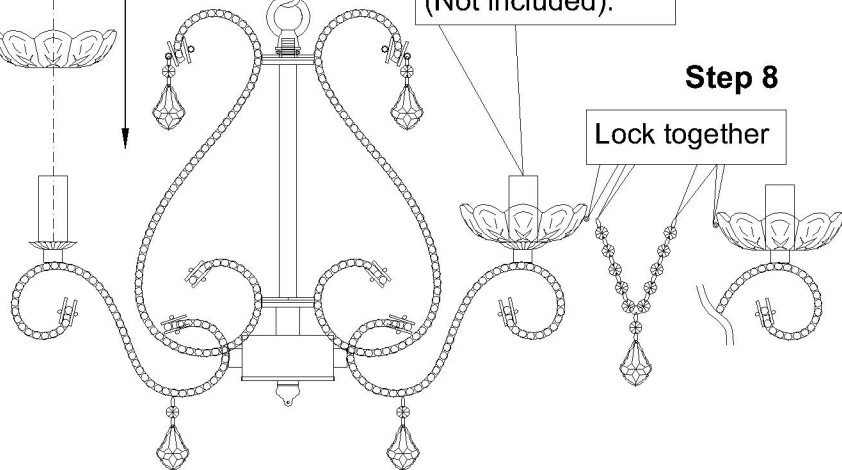

Please note: The parts in this table are completely unassembled, for illustrative purpose. In the actual product that you receive, some parts are assembled and attached together.

