

## NOTICE

\*Please make sure that you have all parts indicated and they are in good condition before you begin assembly of this item. Refer to part list and hardware list below for guidance.

\*This item should be assembled on a soft surface to prevent scratching the finish during assembly.

\*This item may require periodic tightening.

\*If you are having difficulty, our friendly Customer Care team is always here to help. Please email [customersupport@safavieh.com](mailto:customersupport@safavieh.com).

## PREPARATION

\* Before beginning assembly of product, make sure all parts are present. Compare parts with part contents list and hardware contents list.

\* If any part is missing or damaged, do not attempt to assemble the product.





\* Estimated Assembly Time: 10 minutes.

\* Tools Required for Assembly (included): Allen Key

## CARE AND MAINTENANCE

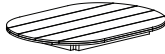
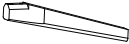
Store outdoor furniture indoors or cover well when not in use. Remove wooden furniture from standing water. Dust regularly with small brush or vacuum. Spills should be taken care of immediately before they harden or stain with a slightly dampened sponge. Do not use bleach solutions

### Part List and Hardware List

PIECE	DESCRIPTION	PICTURE	QUANTITY
A	Top Frame table		1X
B	Leg		4X
HW1	Allen Bolt: M8x0.5x60 mm		8X
HW2	Washer Ø8/20x2 mm		8X
HW3	Allen key 4		1X

Product Dimensions: 23.6" W x 39.4" D x 14.6" H

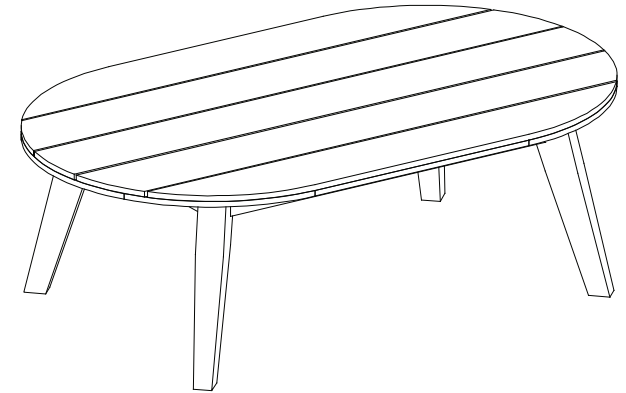

**WARNING**



**Weight Capacity : 40 lbs**

**Warning : Do not stand on table**

**Warning : Do not over torque bolts / screws**

# PREPARATION

- \*Before beginning assembly of product, make sure all parts are present. Compare parts with package contents list and hardware contents list.
- \*If any part is missing or damaged, do not attempt to assemble the product.
- \* Estimated Assembly Time : 10 minutes.
- \* Tools Required for Assembly (included): Allen Key
- \* If you are having difficulty, our friendly Customer care team is always here to help. F

1

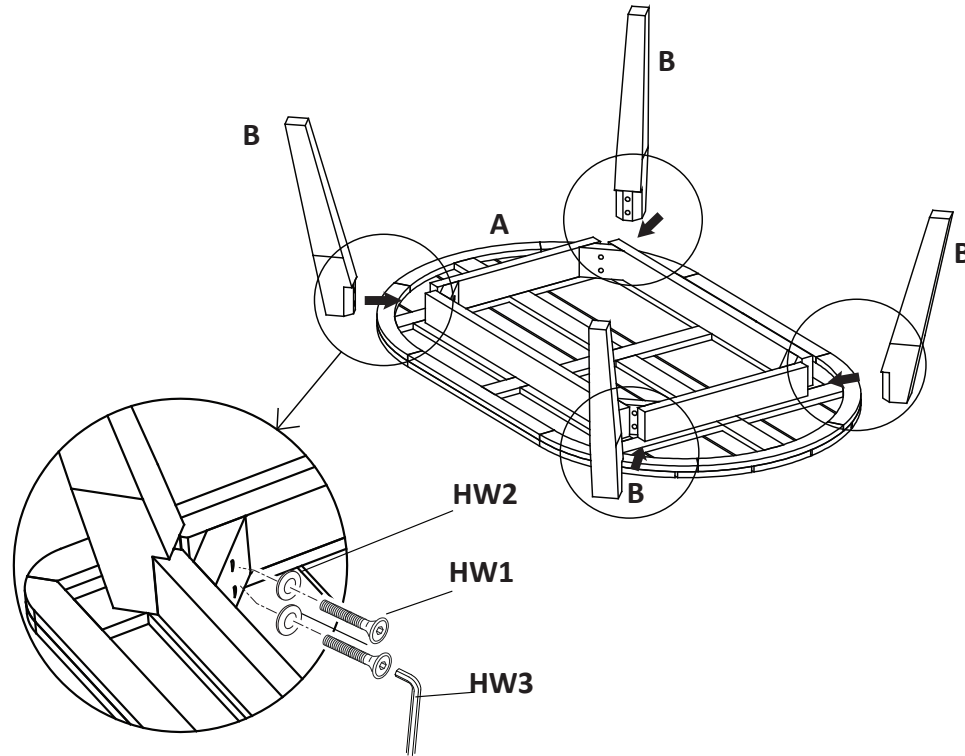

## Step 1

Attach legs (B) to top frame table (A). Using allen bolts (HW1) and insert washer (HW2) tighten with allen key (HW3).