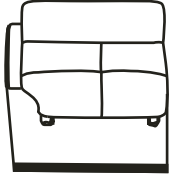
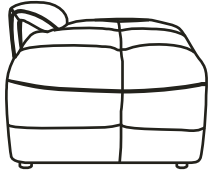

ASSEMBLY INSTRUCTION

LSF CHAISE, PUSH BACK RECLINER

NOTE: Do not use power tools for assembly. Power tools increase the risk of over tightening which leads to splitting or cracking the wood.

COMPONENT LIST (CHAIR)

NO.	DRAWING	QTY	DESCRIPTION
A		1 PC	BACK REST
B		1 PC	SEAT

STEP#1

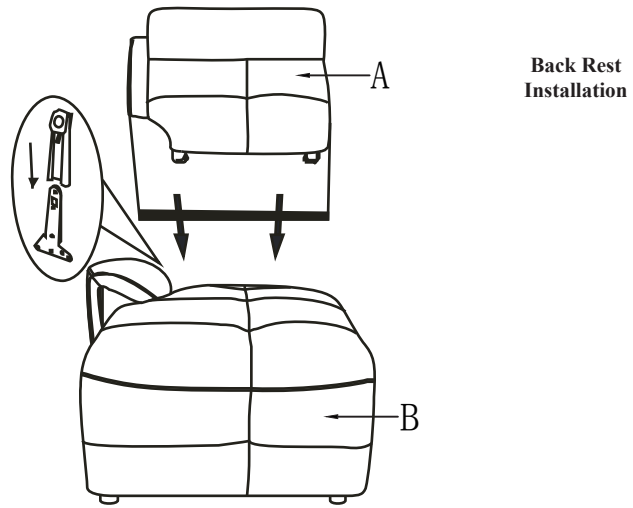

STEP#2

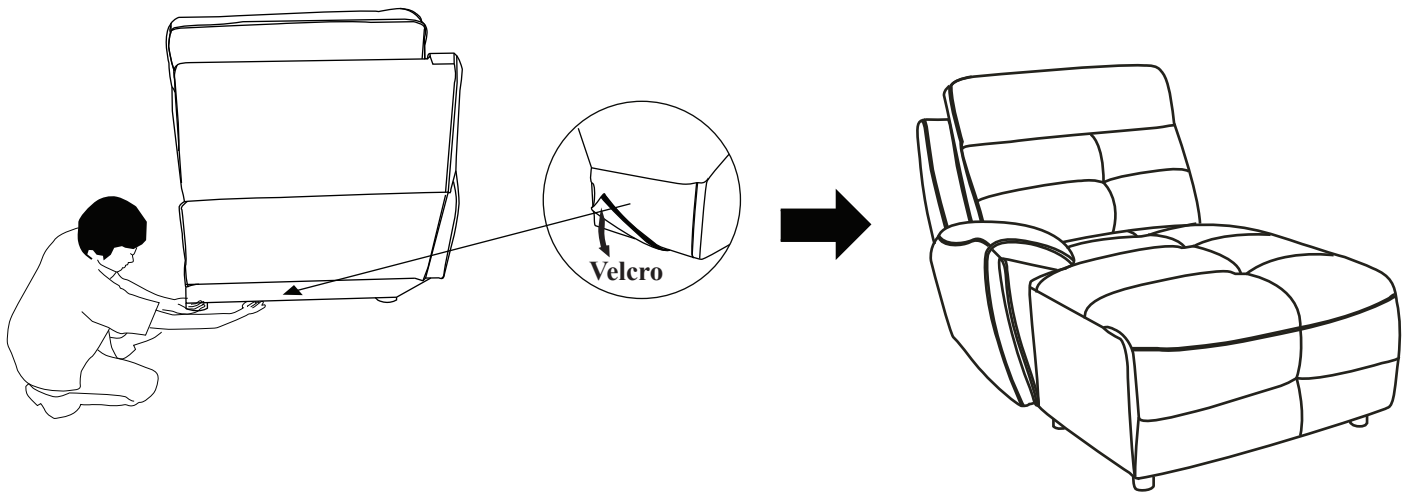

STEP#3

Push back rest to recline the back.

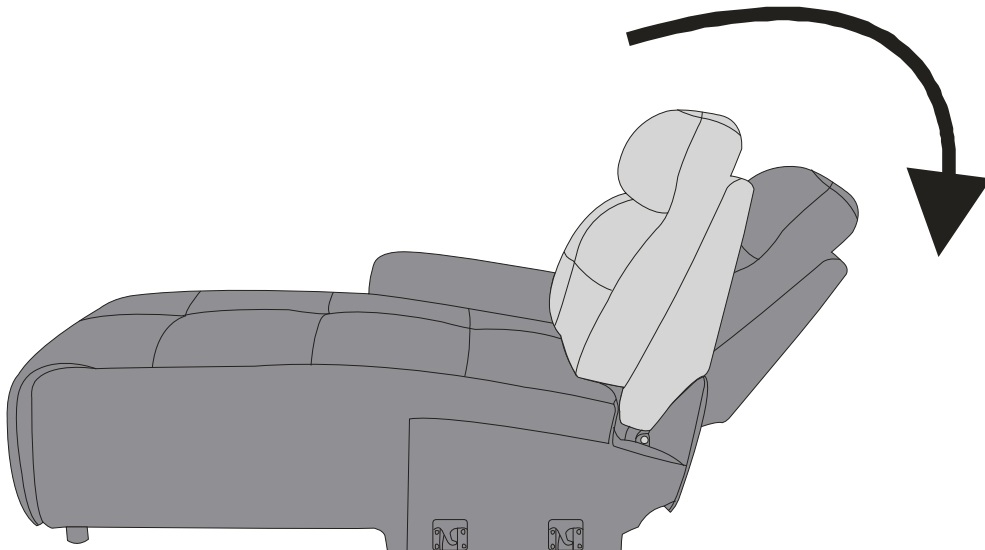

STEP#4

Connect each piece.

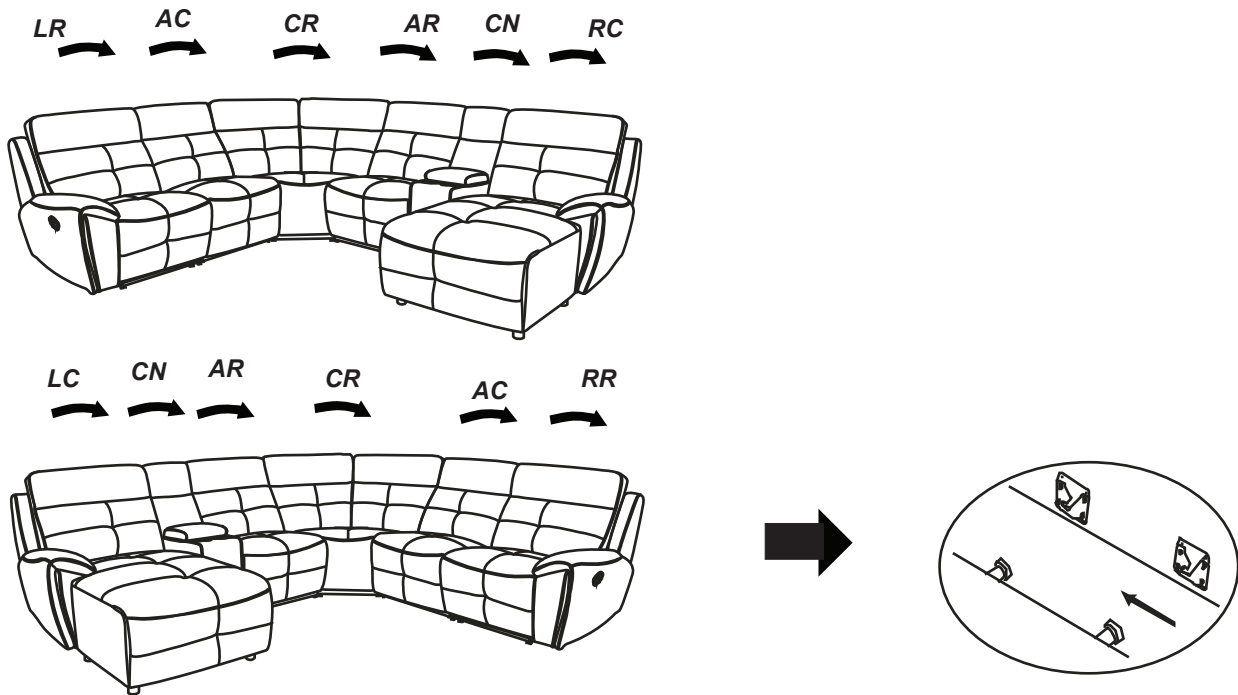

CARE INSTRUCTION FOR POLYESTER:

In order to maintain the original appearance of your polyester furniture, please follow below simple care procedure :

- Avoid exposing furniture directly to sunlight or heating and air conditioning outlets. Exposure to sunlight or heating and air conditioning outlets will fade/damage polyester.
- Wipe gently with a damp soft cloth to remove dust, dirt and any grime build up.
- ⚠ It is recommended to install protective pads under all legs and supports to avoid damage or scratches when placing furniture on a wood floor or other hard surface, and to limit indentation and prevent discoloration if placing on carpet.

ASSEMBLY INSTRUCTION

Armless Chair

NOTE: Do not use power tools for assembly. Power tools increase the risk of over tightening which leads to splitting or cracking the wood.

COMPONENT LIST (CHAIR)

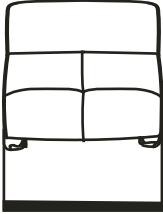
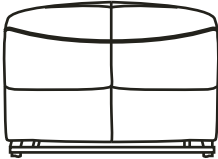
NO.	DRAWING	QTY	DESCRIPTION
A		1 PC	BACK REST
B		1 PC	SEAT

STEP#1

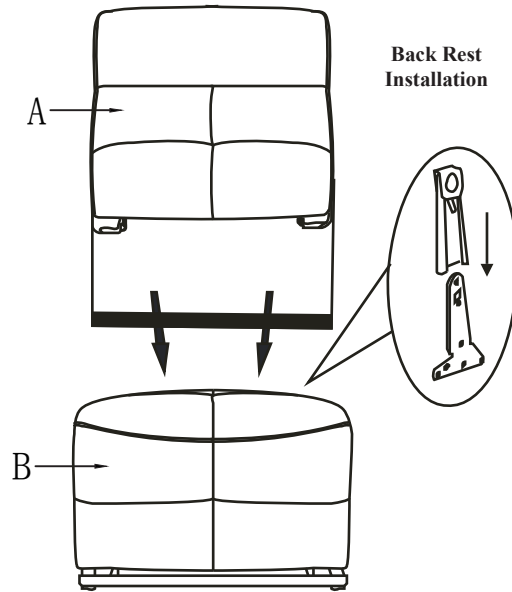

STEP#2

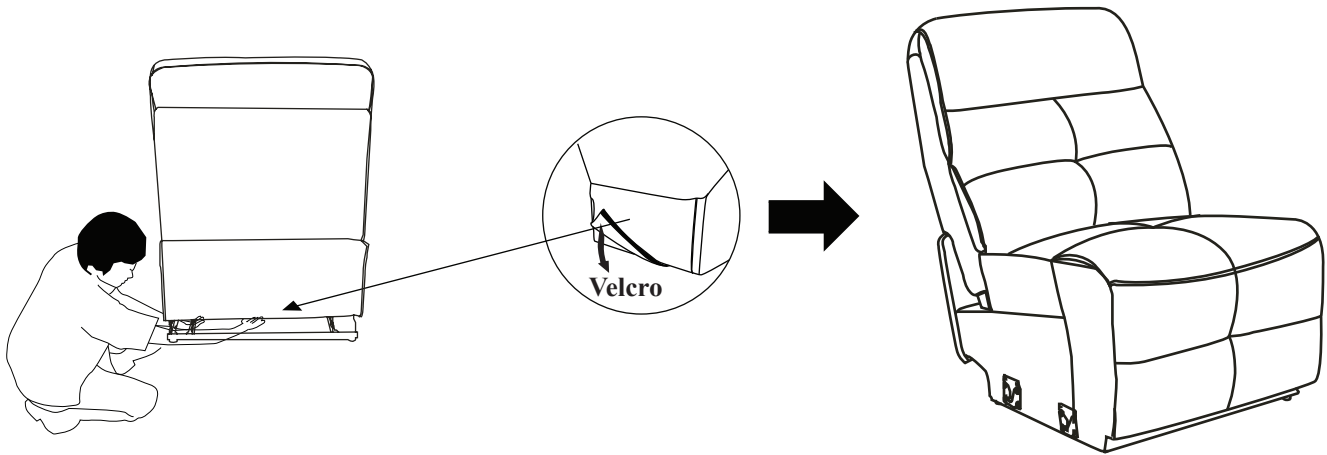

STEP#3

Connect each piece.

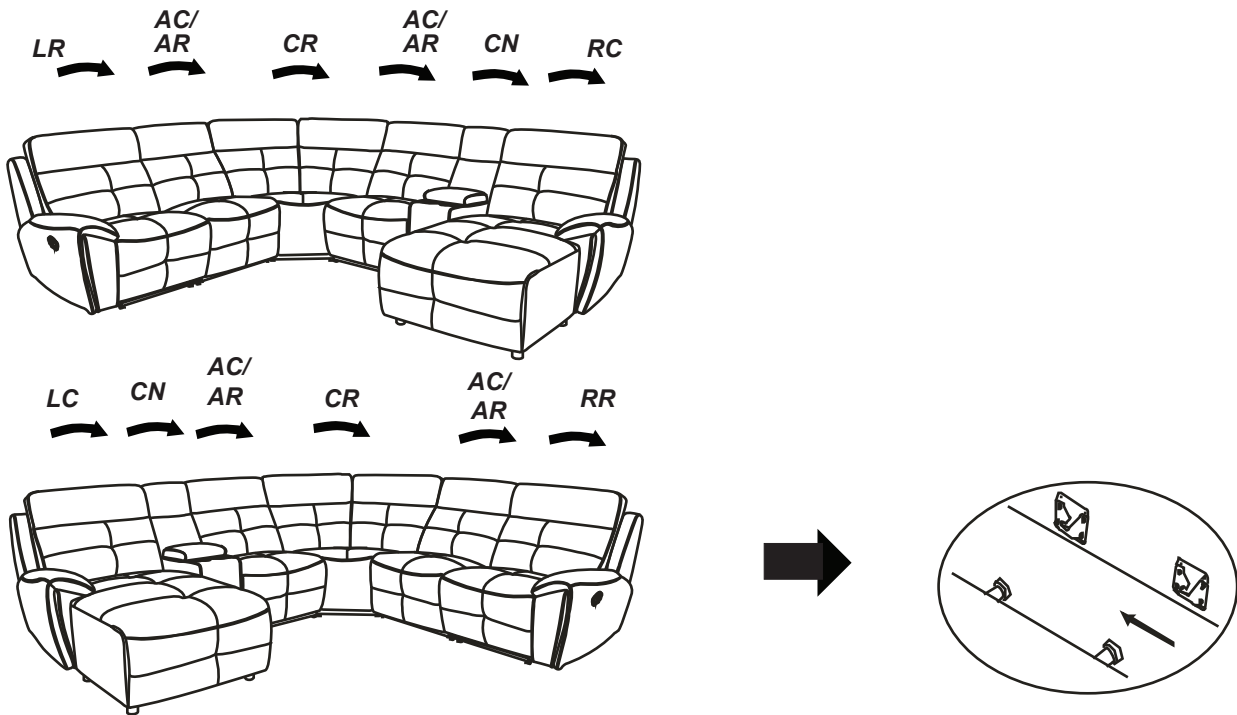

CARE INSTRUCTION FOR POLYESTER:

In order to maintain the original appearance of your polyester furniture, please follow below simple care procedure :



- Avoid exposing furniture directly to sunlight or heating and air conditioning outlets. Exposure to sunlight or heating and air conditioning outlets will fade/damage polyester.
- Wipe gently with a damp soft cloth to remove dust, dirt and any grime build up.

ASSEMBLY INSTRUCTION

Console

NOTE: Do not use power tools for assembly. Power tools increase the risk of over tightening which leads to splitting or cracking the wood.

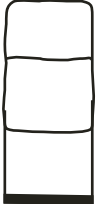
COMPONENT LIST (CHAIR)

NO.	DRAWING	QTY	DESCRIPTION
A		1 PC	BACK REST
B		1 PC	SEAT
C		3 PC	SCREW

STEP#1

Take out the console back from back of seat, then use 3 pcs screws connect console back and seat in specified holes, tighten by hands.

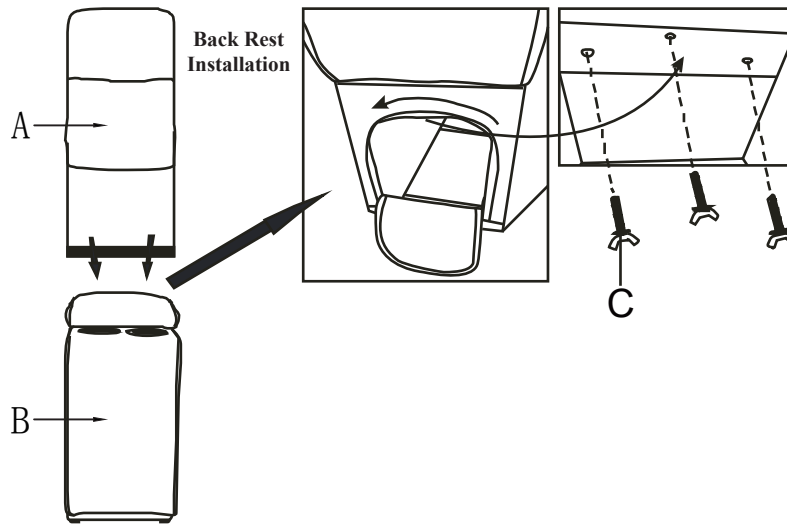

STEP#2

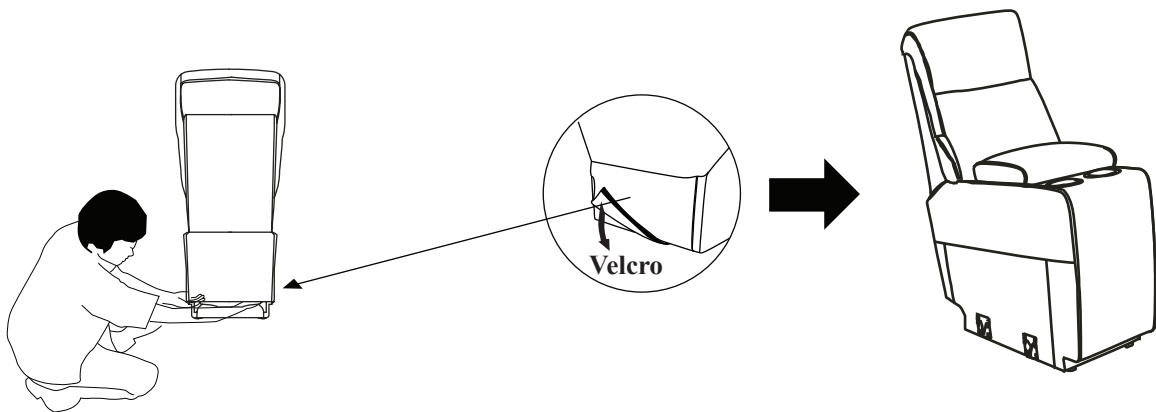

STEP#3

Connect each piece.

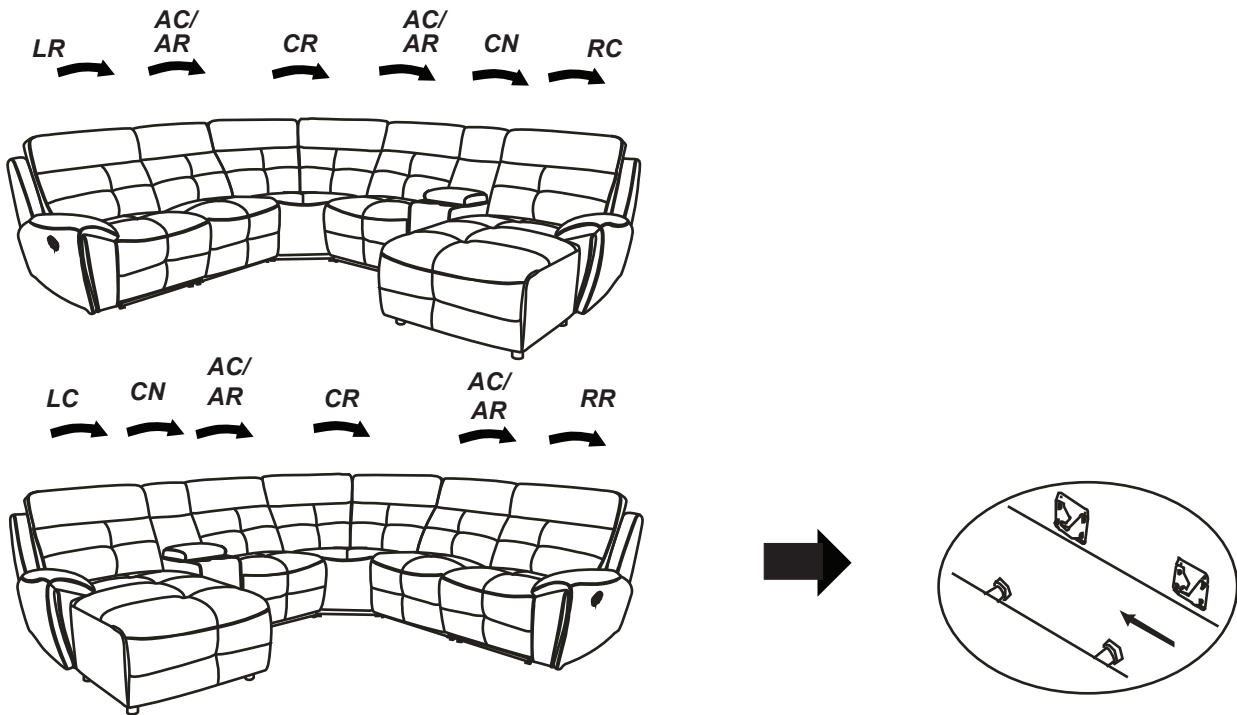

CARE INSTRUCTION FOR POLYESTER:

In order to maintain the original appearance of your polyester furniture, please follow below simple care procedure :

- Avoid exposing furniture directly to sunlight or heating and air conditioning outlets. Exposure to sunlight or heating and air conditioning outlets will fade/damage polyester.
- Wipe gently with a damp soft cloth to remove dust, dirt and any grime build up.

ASSEMBLY INSTRUCTION

Corner Seat

NOTE: Do not use power tools for assembly. Power tools increase the risk of over tightening which leads to splitting or cracking the wood.

COMPONENT LIST (CHAIR)

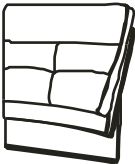
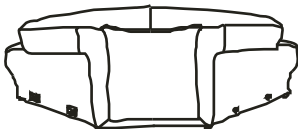
NO.	DRAWING	QTY	DESCRIPTION
A		1 PC	LSF BACK REST
B		1 PC	RSF BACK REST
C		1 PC	SEAT

STEP#1

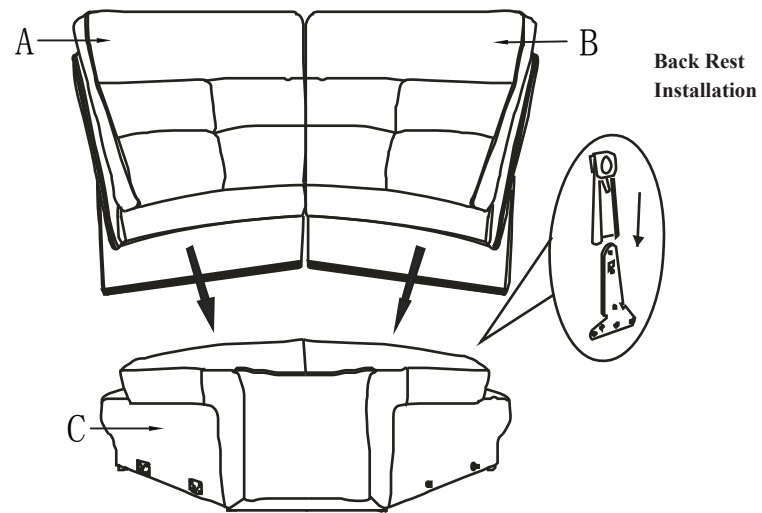

STEP#2

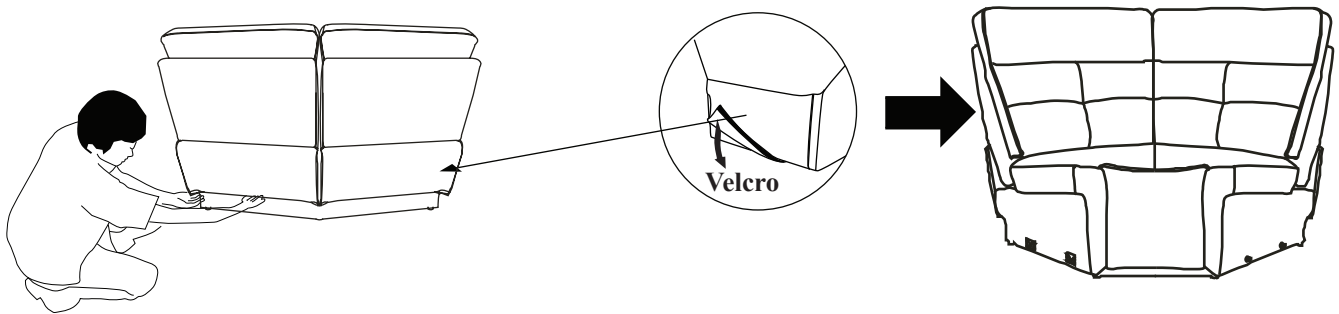

STEP#3

Connect each piece.

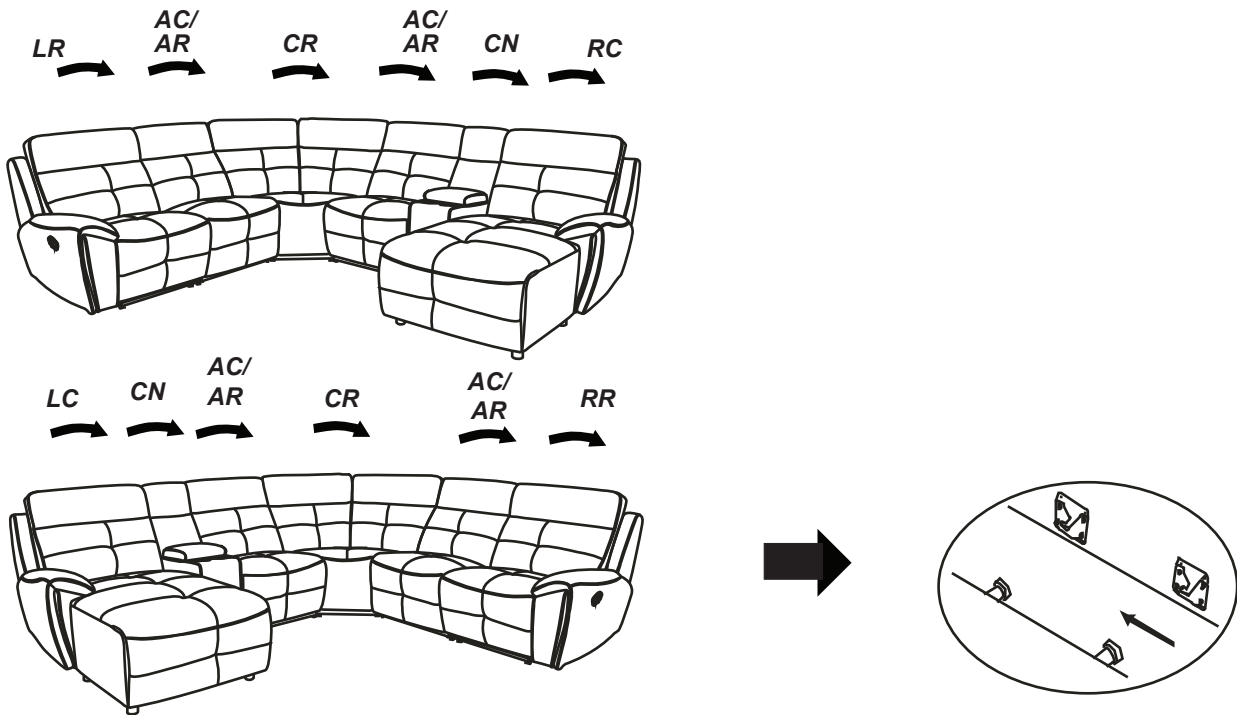

CARE INSTRUCTION FOR POLYESTER:

In order to maintain the original appearance of your polyester furniture, please follow below simple care procedure :

- Avoid exposing furniture directly to sunlight or heating and air conditioning outlets. Exposure to sunlight or heating and air conditioning outlets will fade/damage polyester.
- Wipe gently with a damp soft cloth to remove dust, dirt and any grime build up.

ASSEMBLY INSTRUCTION

Armless Reclining Chair

NOTE: Do not use power tools for assembly. Power tools increase the risk of over tightening which leads to splitting or cracking the wood.

COMPONENT LIST (CHAIR)

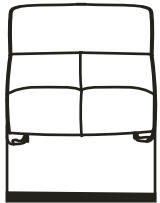
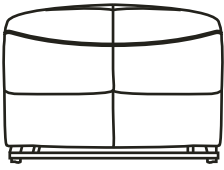
NO.	DRAWING	QTY	DESCRIPTION
A		1 PC	BACK REST
B		1 PC	SEAT

STEP#1

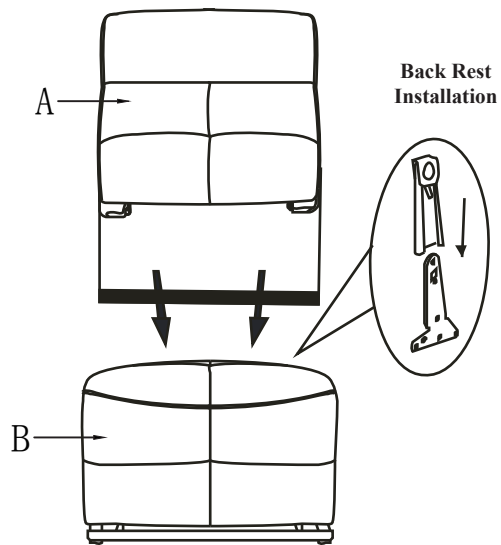

STEP#2

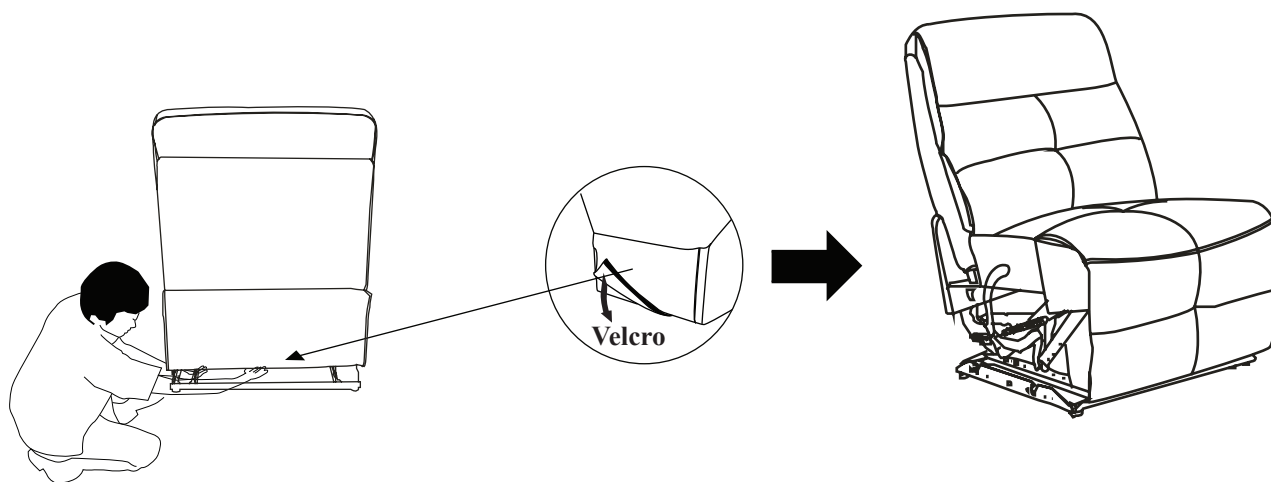

STEP#3

Use the handle to open the recliner.

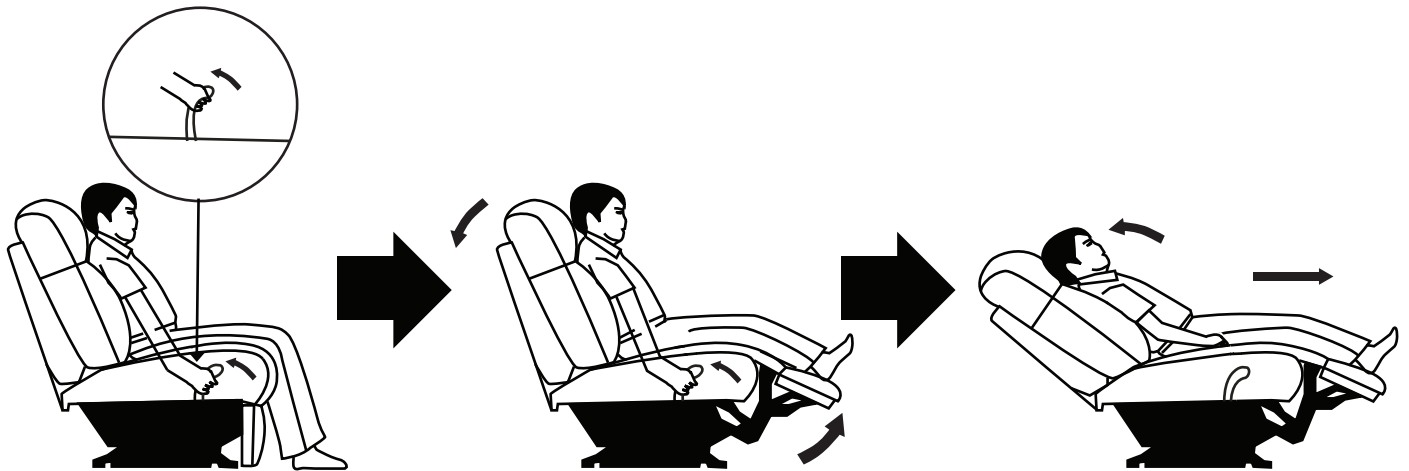

STEP#4

Connect each piece.

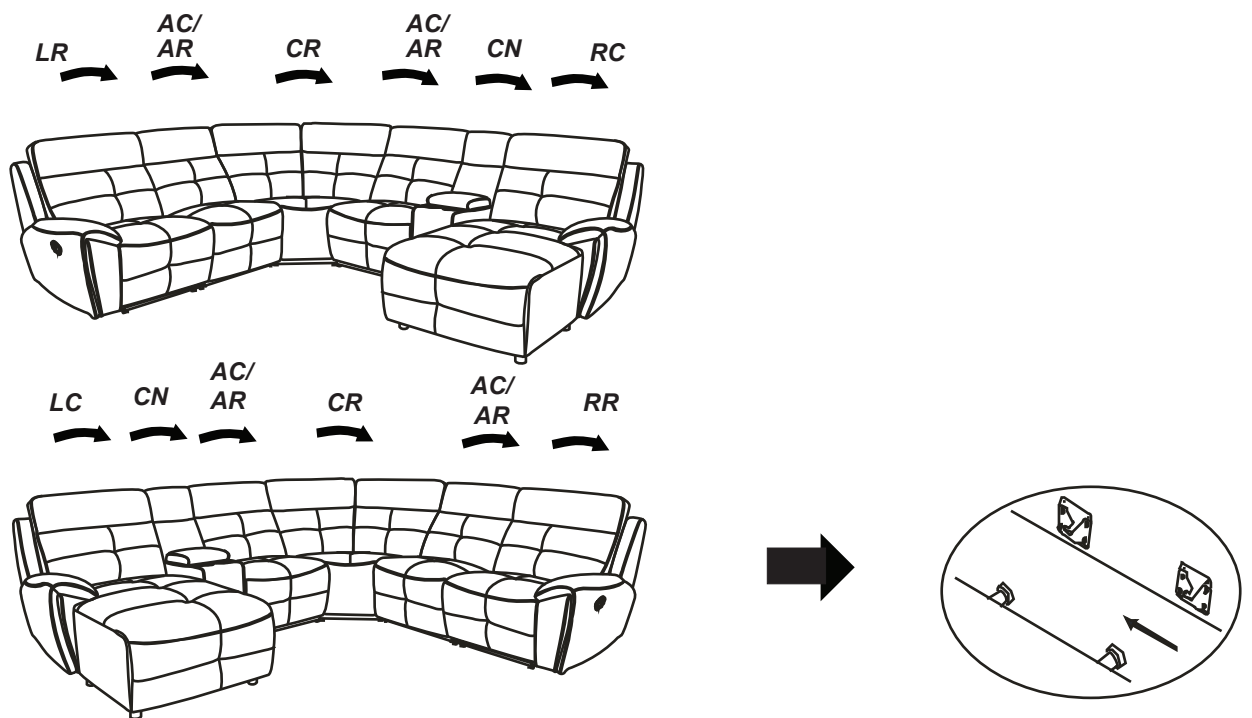

CARE INSTRUCTION FOR POLYESTER:

In order to maintain the original appearance of your polyester furniture, please follow below simple care procedure :

- Avoid exposing furniture directly to sunlight or heating and air conditioning outlets. Exposure to sunlight or heating and air conditioning outlets will fade/damage polyester.
- Wipe gently with a damp soft cloth to remove dust, dirt and any grime build up.

ASSEMBLY INSTRUCTION

RSF Reclining Chair

NOTE: Do not use power tools for assembly. Power tools increase the risk of over tightening which leads to splitting or cracking the wood.

COMPONENT LIST (CHAIR)

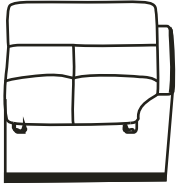
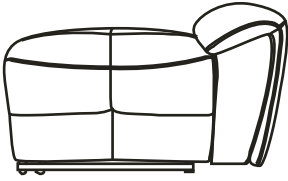
NO.	DRAWING	QTY	DESCRIPTION
A		1 PC	BACK REST
B		1 PC	SEAT

STEP#1

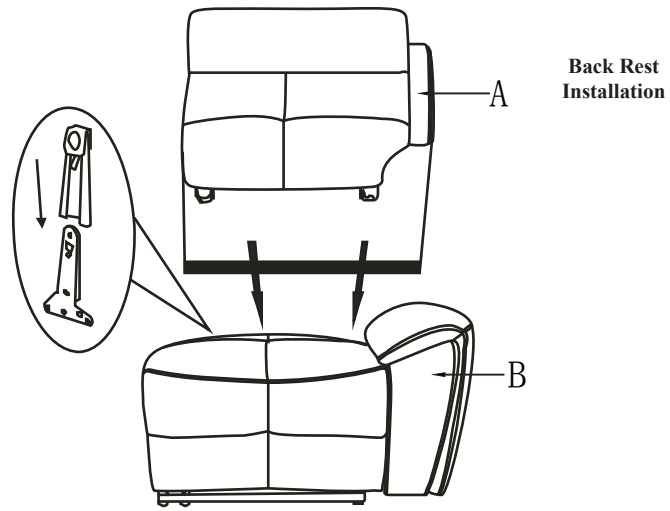

STEP#2

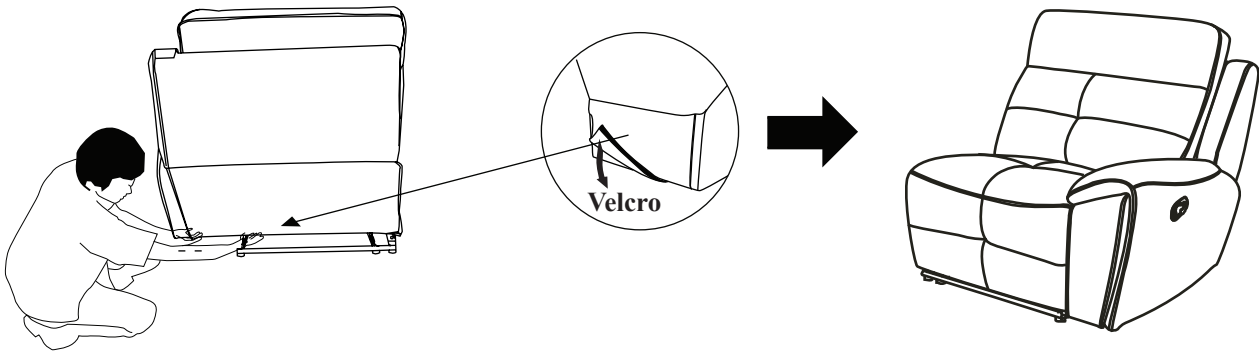

STEP#3

Connect each piece.

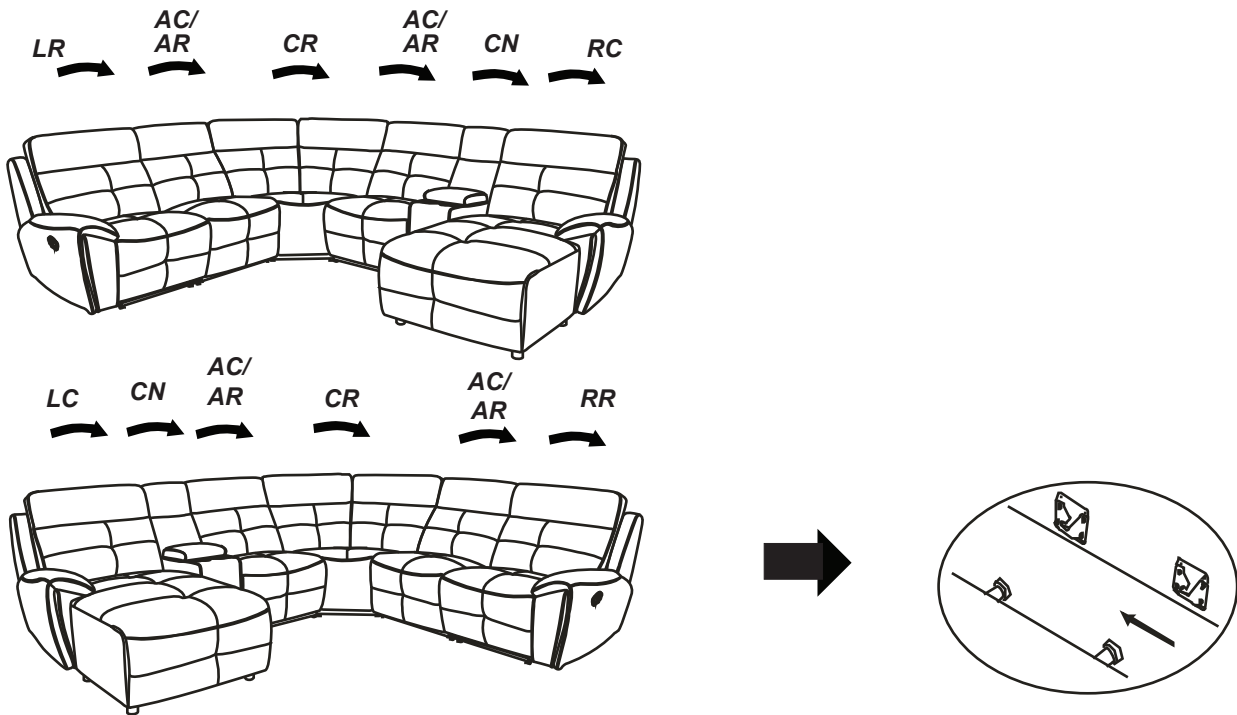

CARE INSTRUCTION FOR POLYESTER:

In order to maintain the original appearance of your polyester furniture, please follow below simple care procedure :

- Avoid exposing furniture directly to sunlight or heating and air conditioning outlets. Exposure to sunlight or heating and air conditioning outlets will fade/damage polyester.
- Wipe gently with a damp soft cloth to remove dust, dirt and any grime build up.