

INSTRUCTION MANUAL

11FT x 11FT Gazebo

Series E15

IF YOU PURCHASED THE GAZEBO ONLINE AND HAVE ANY
QUESTIONS OR CONCERNS
PLEASE CONTACT US WITH EMAIL OR TEXT

Email: service2outdoor@gmail.com

Text: +1 628 263 4608

Lost accessories or parts costs will be incurred after 90 days
of the date of purchase.

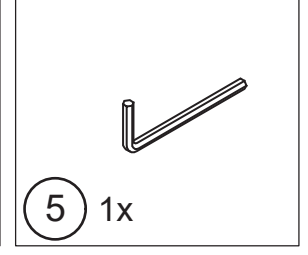
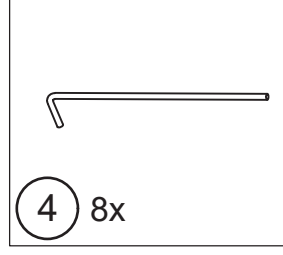
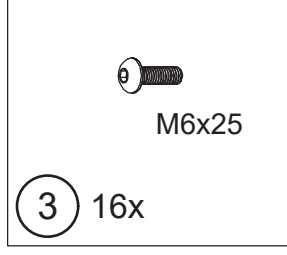
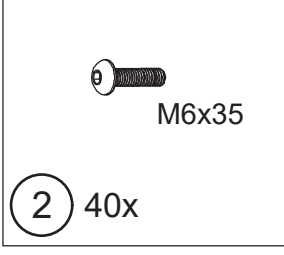
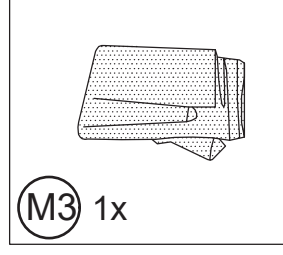
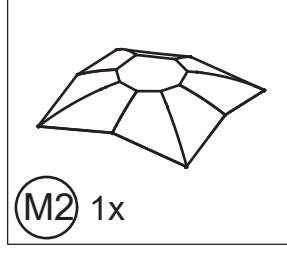
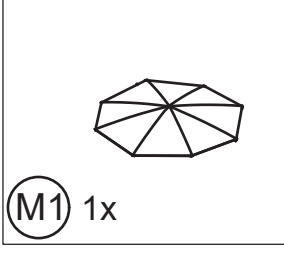
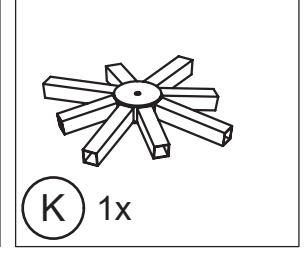
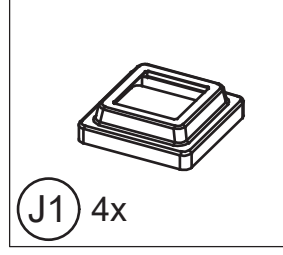
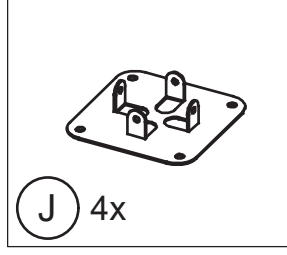
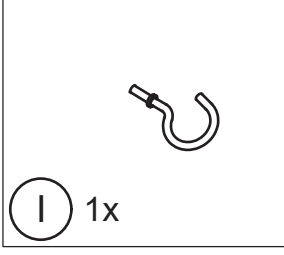
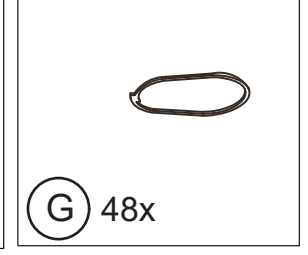
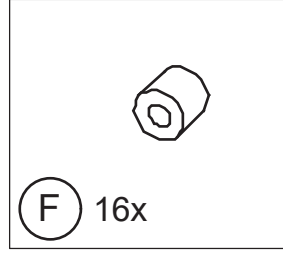
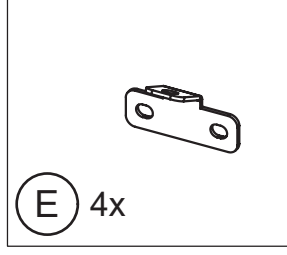
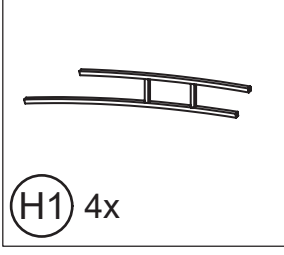
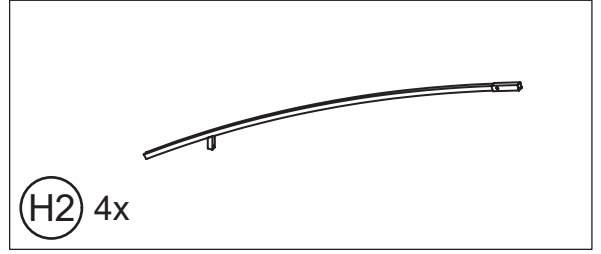
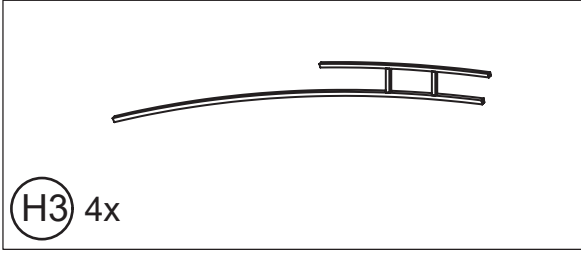
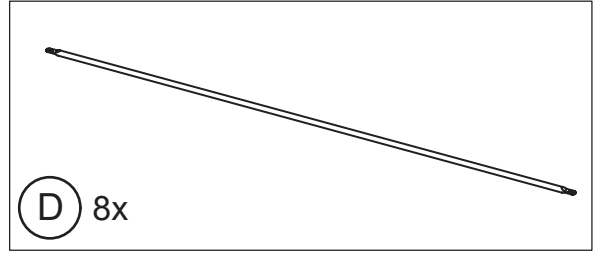
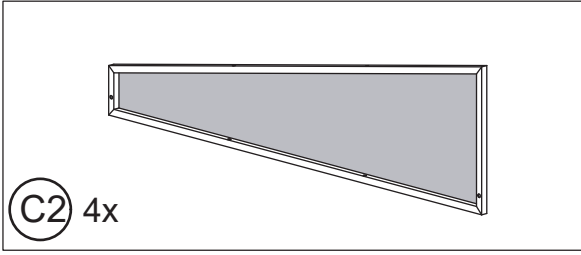
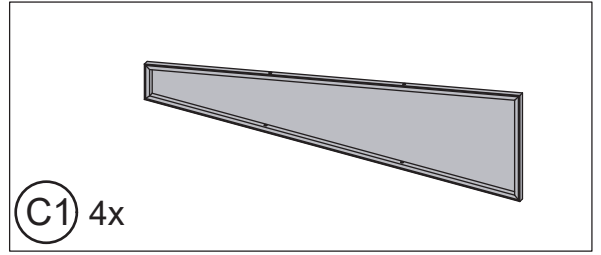
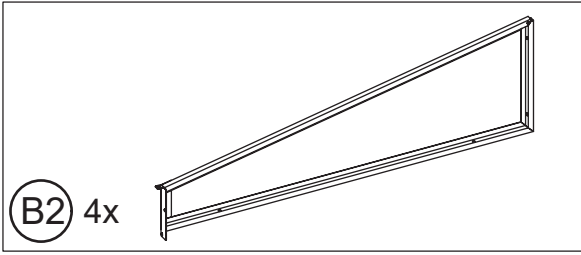
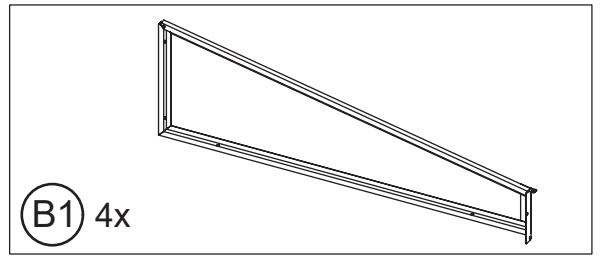
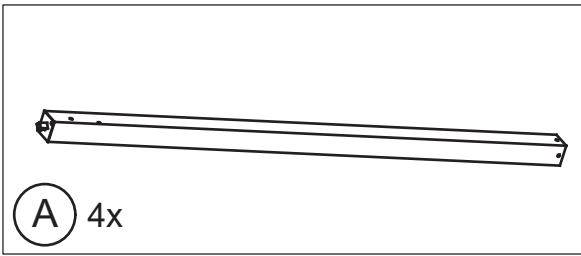

<1>

A 4x



J 4x



J1 4x

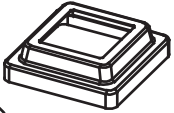

1 16x



M6x15

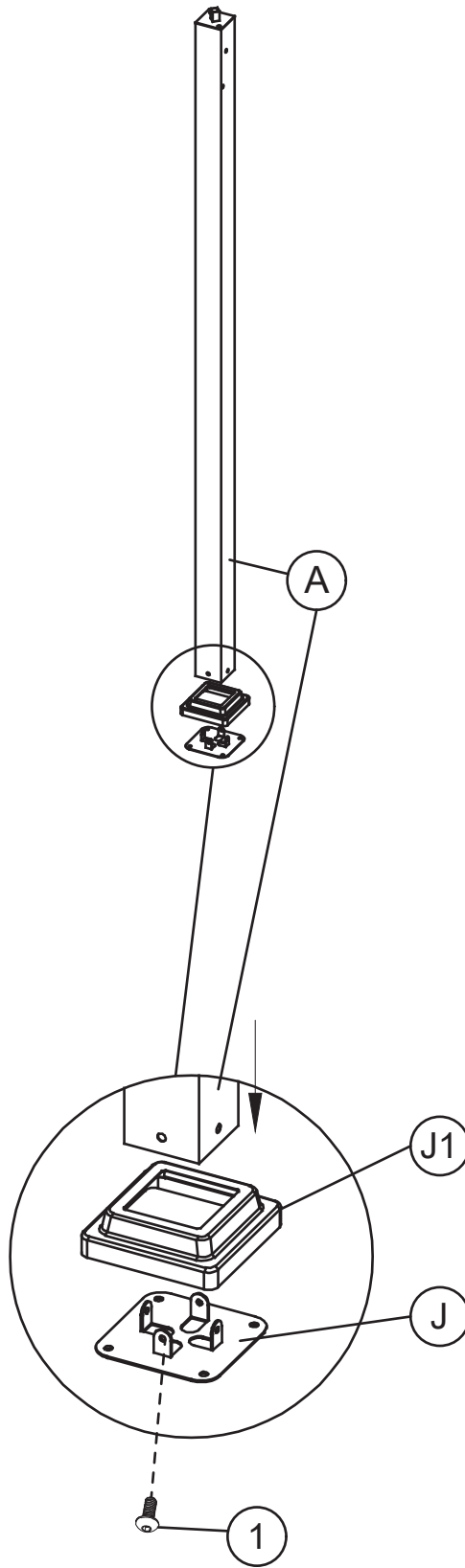

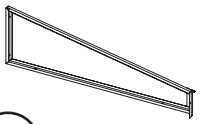

(B1) 4x

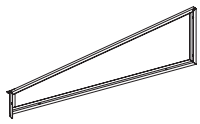

(B2) 4x



M6x15

(1) 24x



M6x35

(2) 8x

<2>

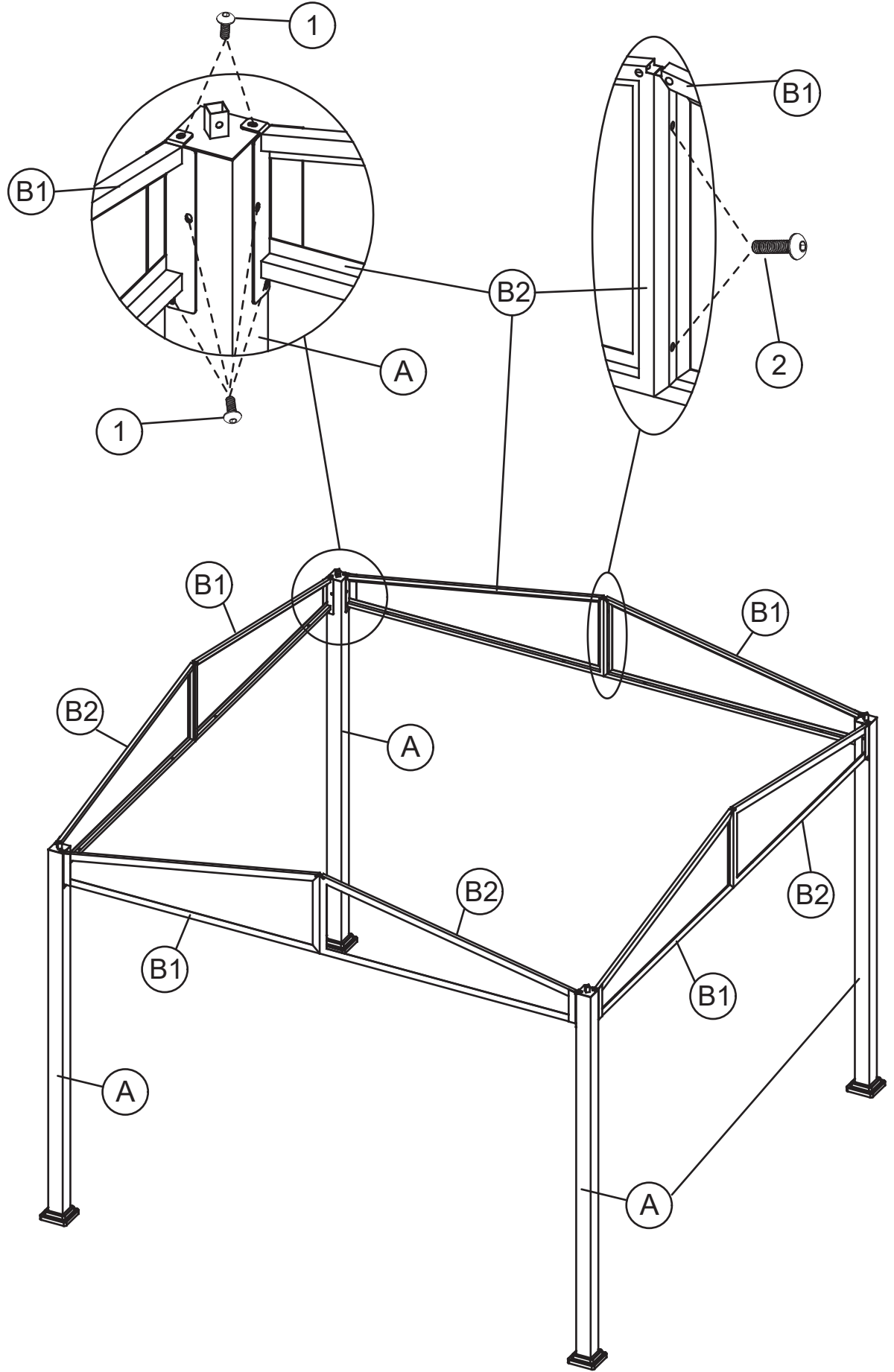

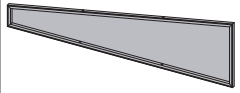

(C1) 4x

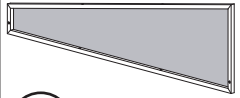

(C2) 4x



M6x35

(2) 32x

<3>

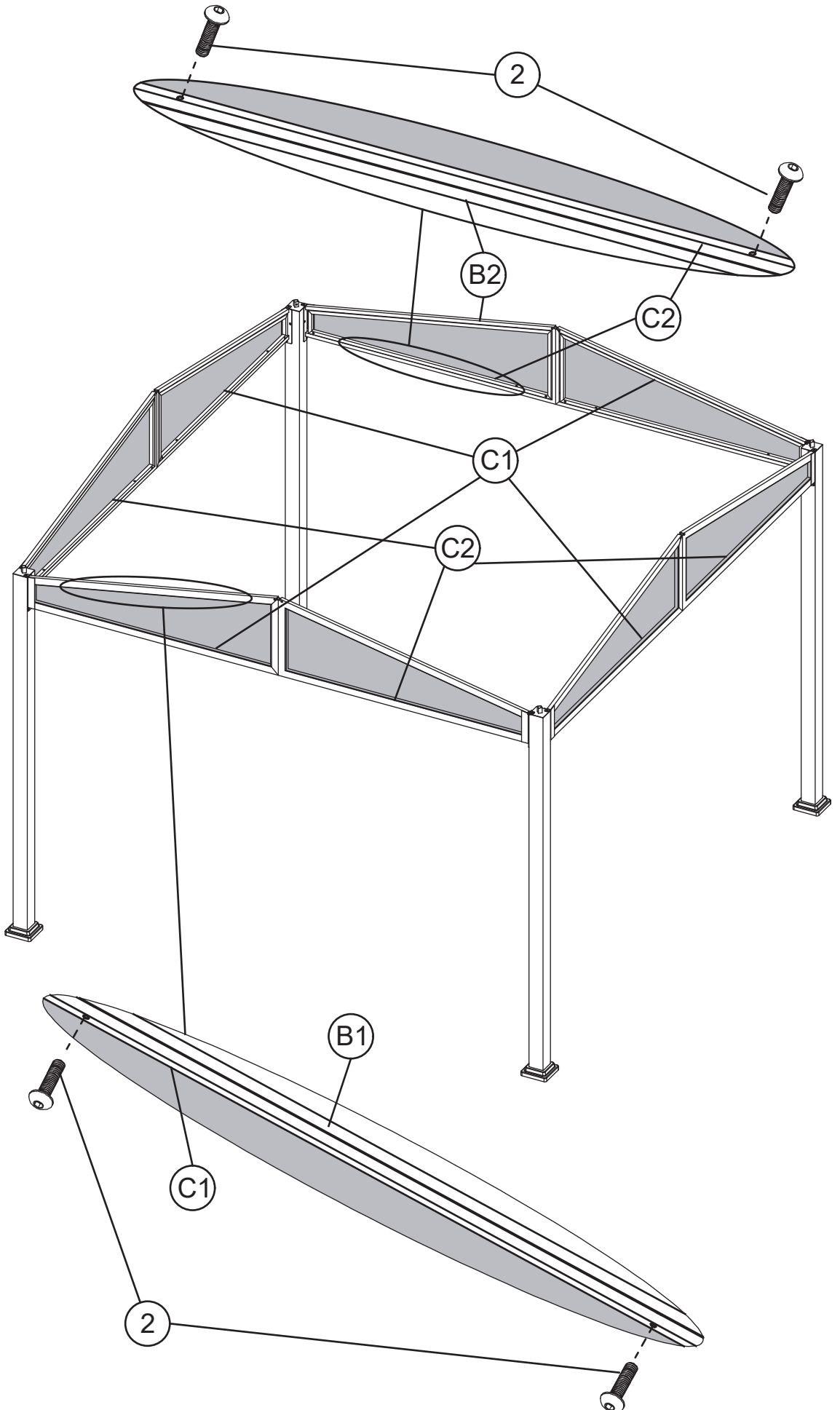

5



(D) 8x

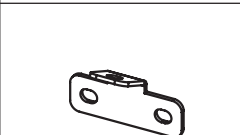

(E) 4x

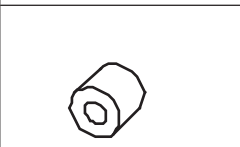

(F) 16x

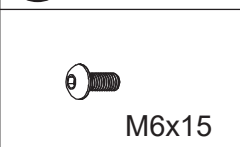

(1) 8x
M6x15



(3) 16x
M6x25

<4>

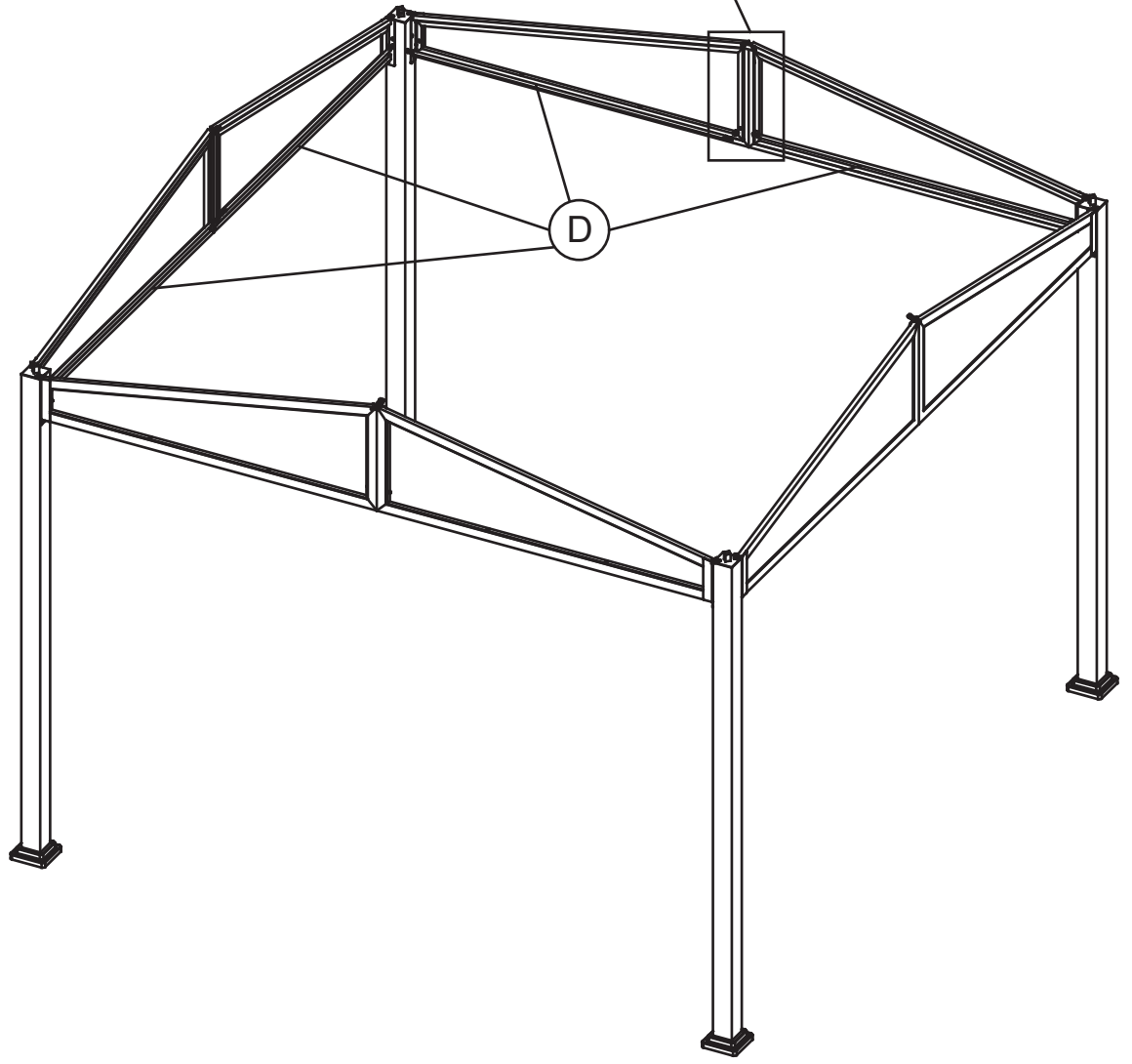
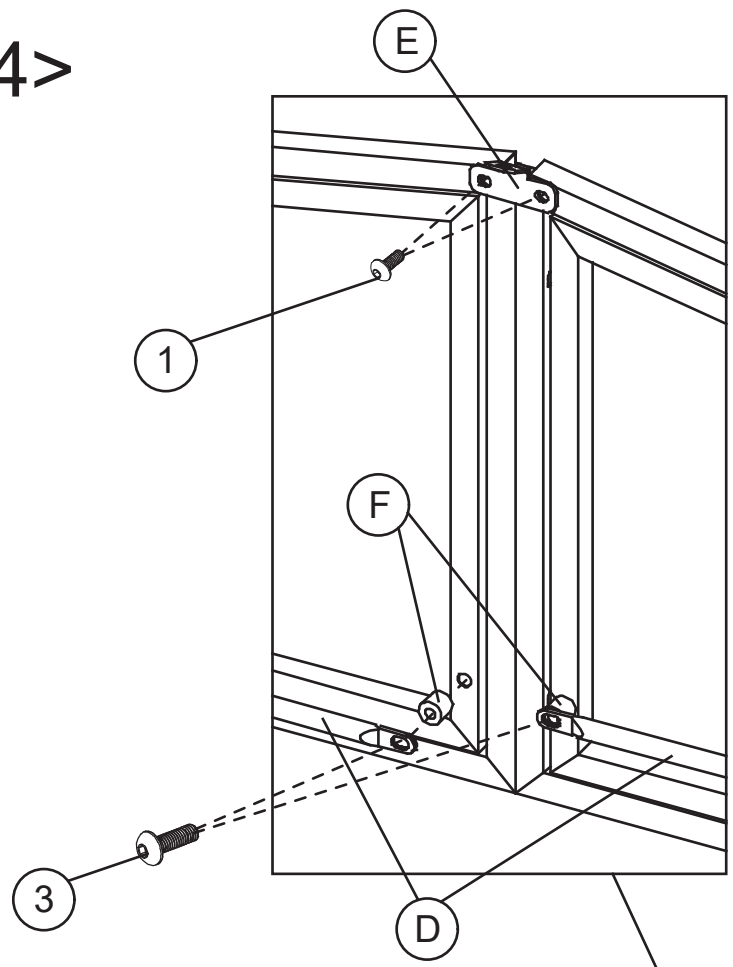

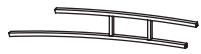

(H1) 4x



(H2) 4x



(K) 1x



(I) 1x

<5>

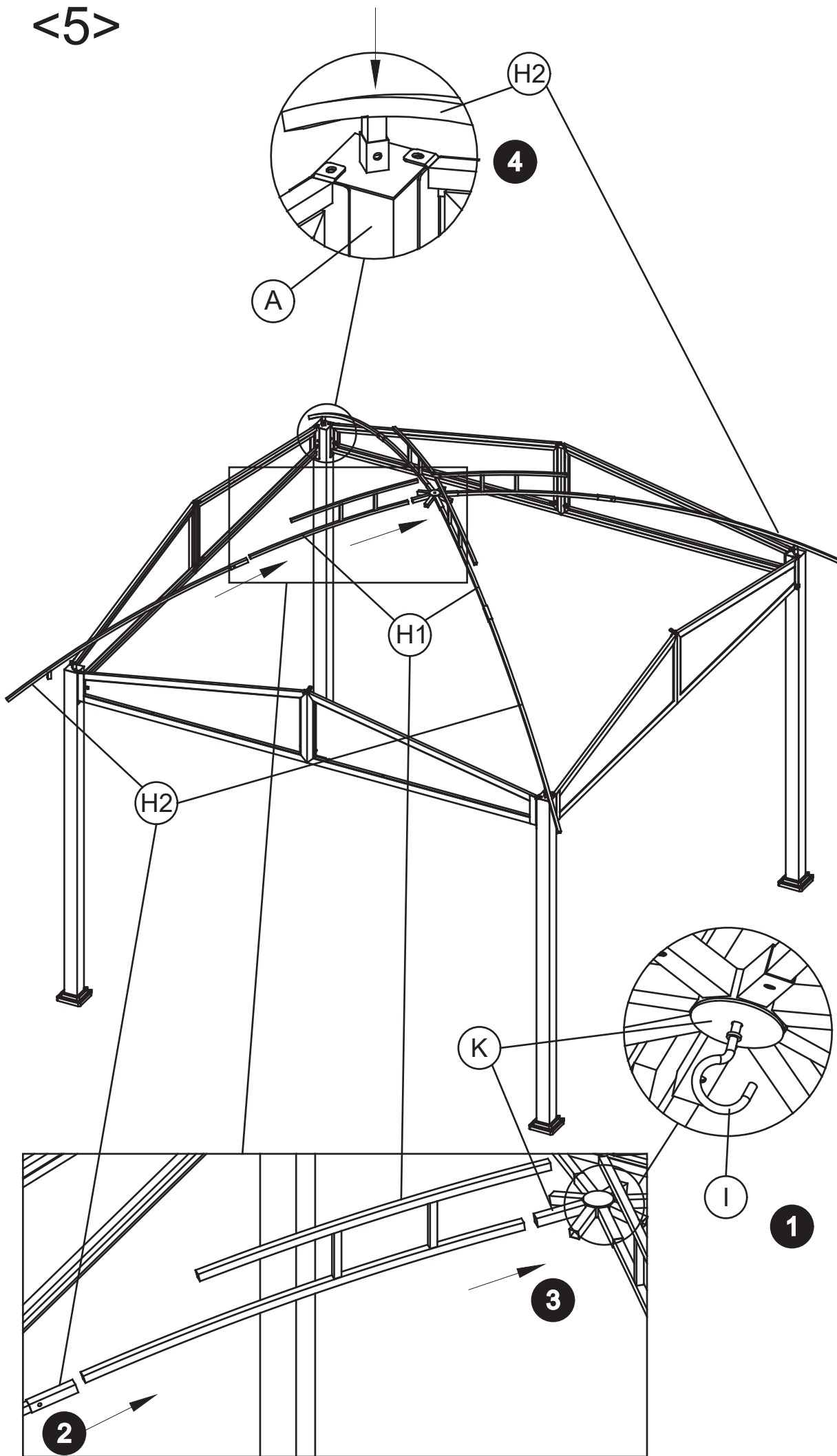

7



(H3) 4x



M6x15

(1) 4x

<6>

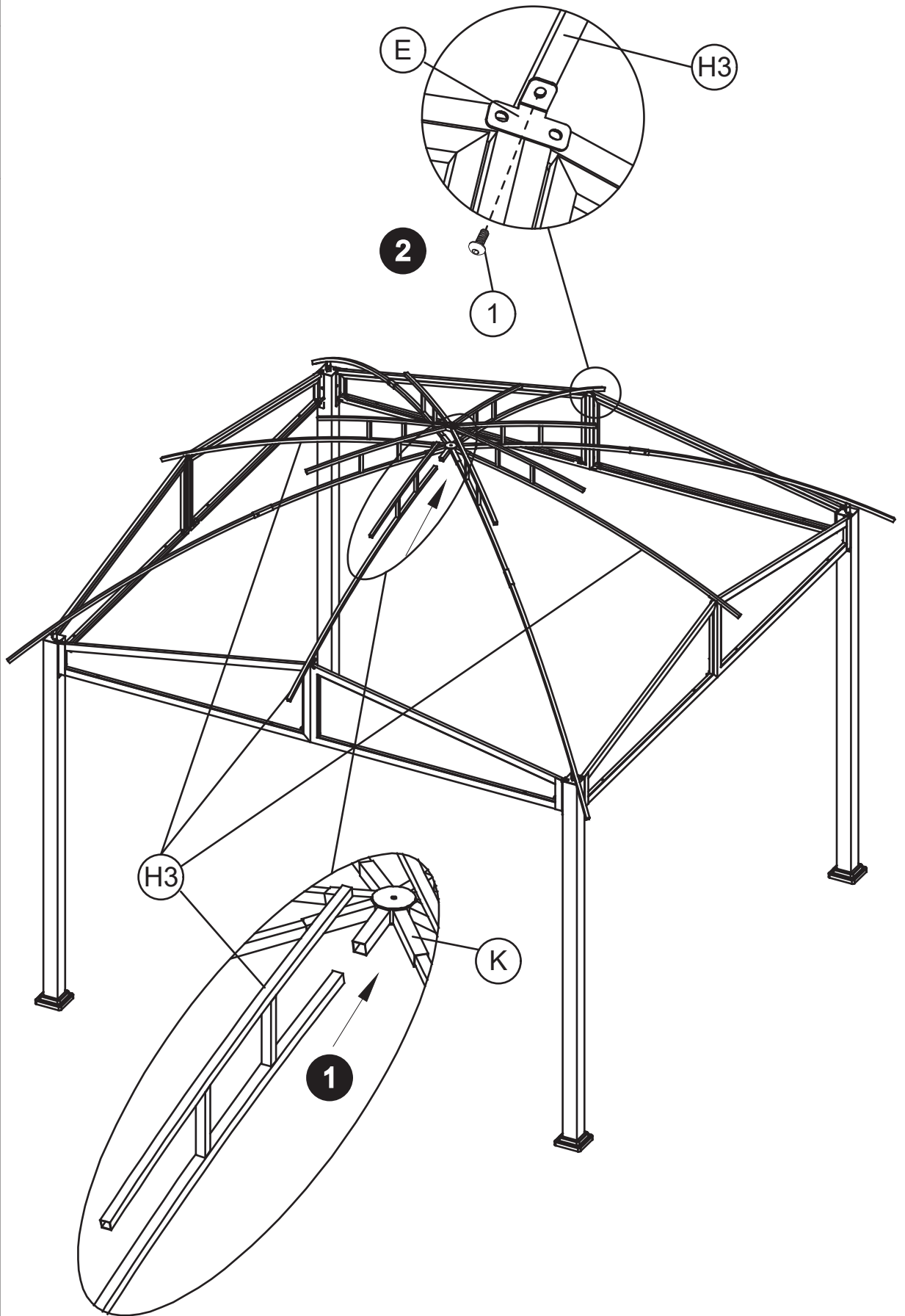



(M1) 1x



(M2) 1x

<7>

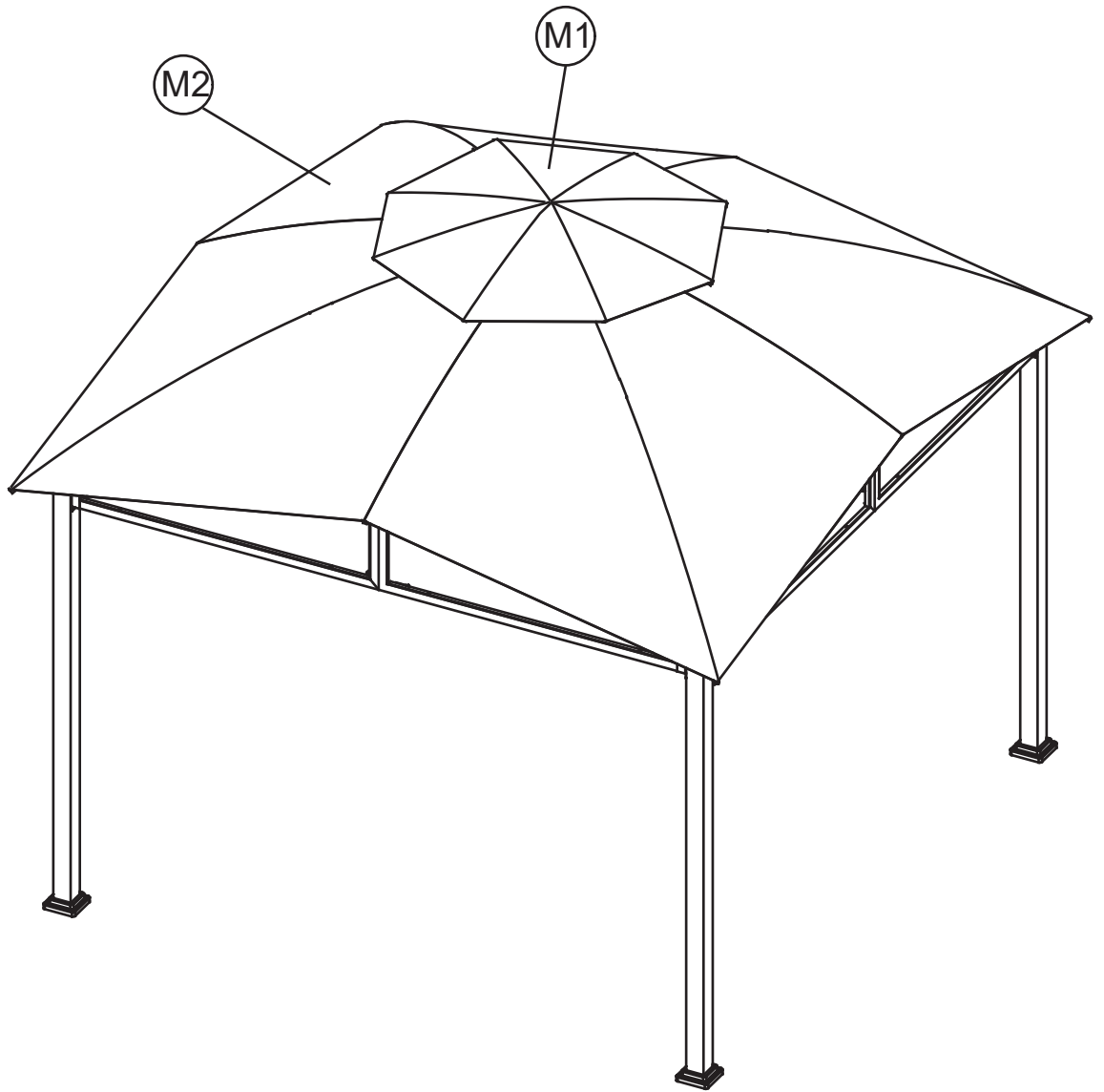

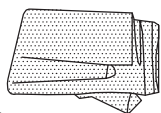

(M3) 1x



(G) 48x

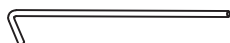

(4) 8x

<8>

