

ASSEMBLY INSTRUCTIONS

Pre-Assembly and parts list

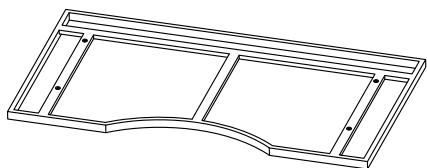

A × 1pc

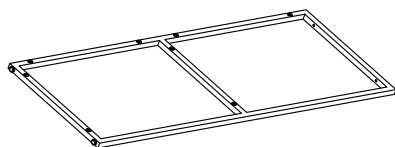

B × 2pcs

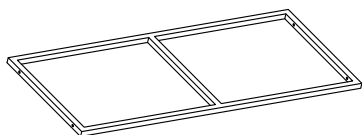

C × 2pcs

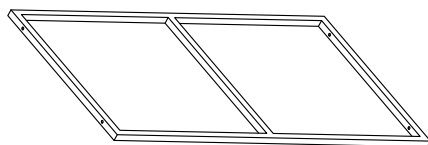

D × 2pcs

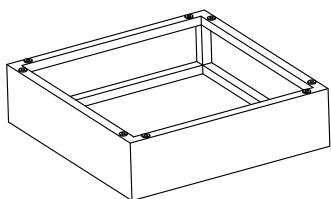

E × 4pcs

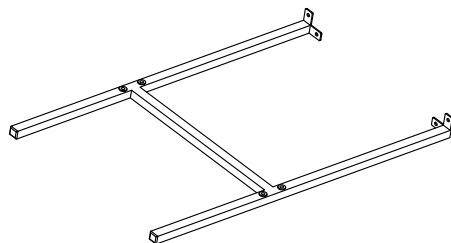

F × 8pcs

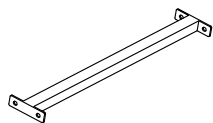

G × 8pcs

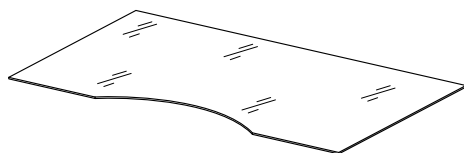





H × 1pc

Pre-Assembly and parts list

HARDWARE INCLUDED



NOTED: Hardware not shown to actual size.

Part	Description	Size	QTY.
I		(M6x30)	20
J		(M6x15)	64
K			84
L			1

Assembly

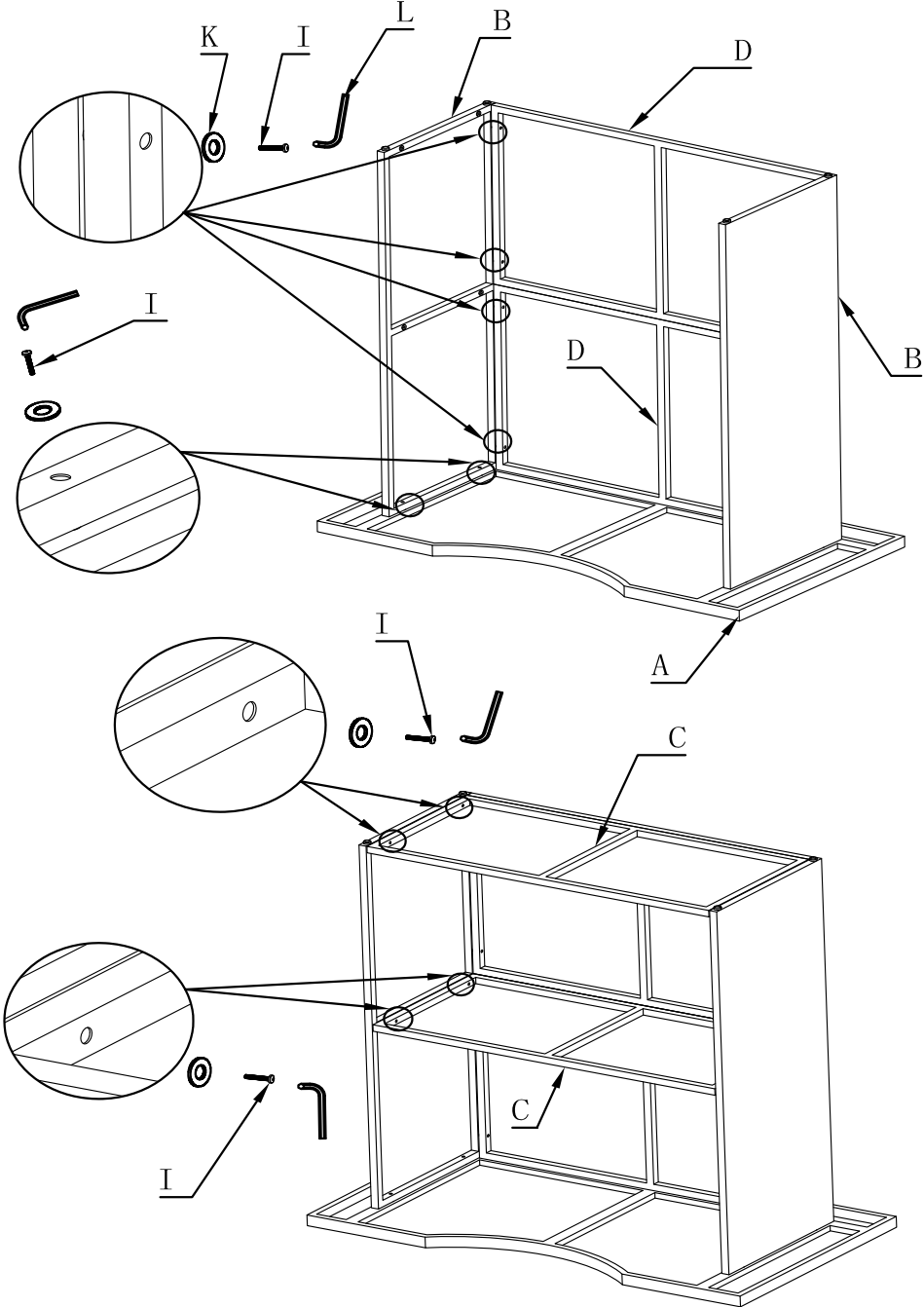

Assembly

