

# EROMMY!

Closer to Life!

—  
**WQSP255TN**

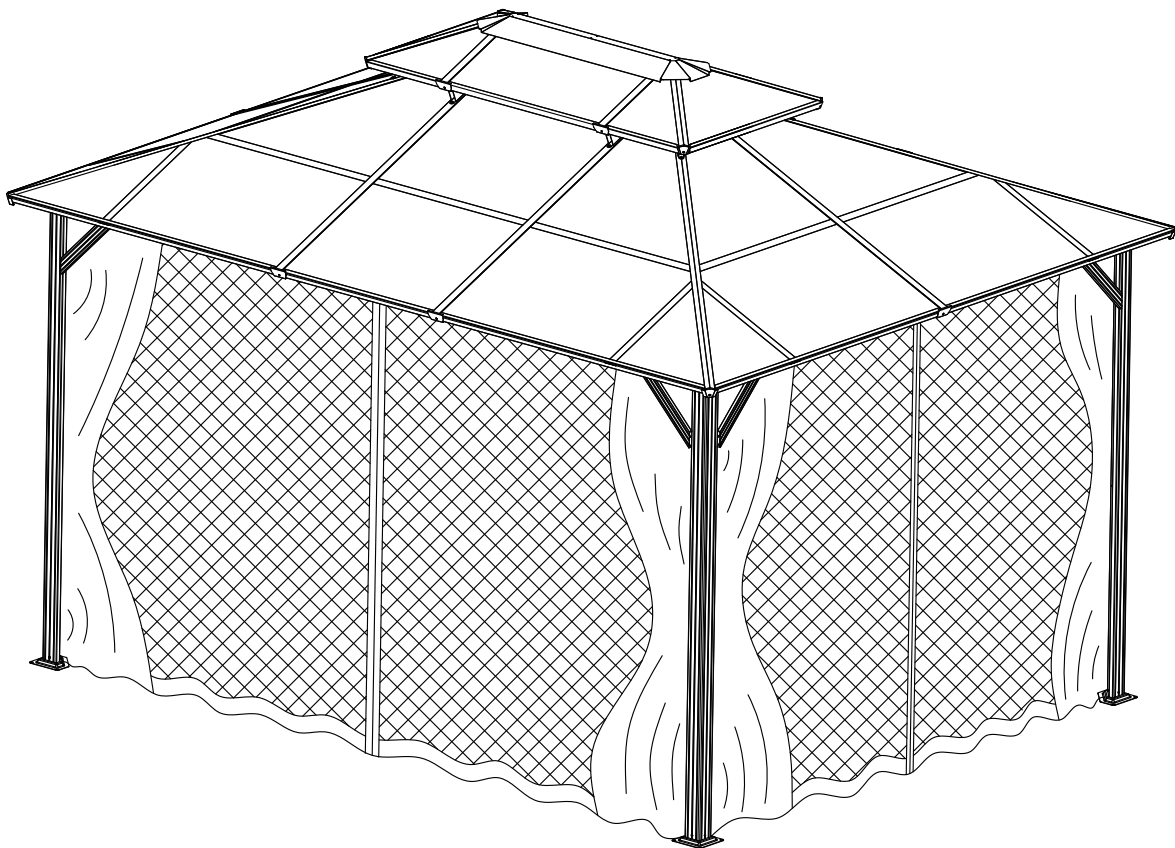

10x12.8ft

# PC ROOF GAZEBO

---

Installation instructions

# EROMMY PRODUCT INSTRUCTION

**i** Remember that the assembly might take ( 5 ) hours and requires ( 4 ) people.

## REMEMBER

EROMMY isn't responsible for replacing parts lost or damaged during assembly. If you have issues, Email: [service@erommy.com](mailto:service@erommy.com) or Tel: **8886766299** instead of returning the unit.

## IMPORTANT

Finalize site preparation and foundation construction before unpacking. Remove all parts from the packaging and check the right count and type of pieces before assembling.

## ! CAUTION

- Consult local authorities to ensure you have the required permits and are aware of any applicable local building regulations.
- It's crucial to review the site preparation information in the manual beforehand to get everything ready.
- Read instructions thoroughly before starting assembly. Follow the steps carefully because the kit contains parts that might be damaged if constructed incorrectly.
- Please handle the kit with caution since some parts have sharp metal edges.
- Avoid working in severe winds or extreme cold and wear gloves, eye protection, and long sleeves during assembly or maintenance.
- When filling it, store heavier items near the bottom. The product isn't intended for children to play in, and don't stand, sit, or store anything on the roof.

## BRAND STORY

Guided by the ideology of “Closer to Life” , EROMMY is committed to bringing you refined and trustworthy products that fit your needs. Our vision is to empower every customer to stay close to nature and ultimately transform their lifestyle.

EROMMY, Closer to Life!



# PACKING LIST

Serial number

## Box A

Part name	C	C1	D1	D4	E	E1	E2
Qty	4	4	4	4	4	4	4
Part name	E3	E4	F2	F3	F4	G	H
Qty	4	2	2	2	2	4	1
Part name	H1	I	J	J1	J2	J3	K
Qty	1	2	4	4	4	4	4
Part name	K1	K2	K3	L	L1	L2	Q
Qty	4	4	2	2	2	2	1
Part name	Q1	Q2	S	T	T1	M	N
Qty	8	2	4	4	1	4	4
Part name	N1	O	O1	O2	O3	P	P1
Qty	4	8	8	4	6	8	10
Part name	P2	R	U				
Qty	3	4	80				

# PACKING LIST













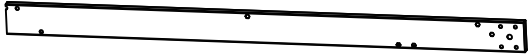
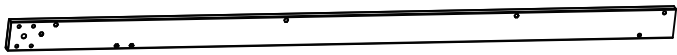
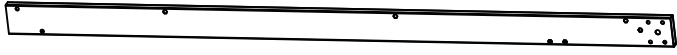

Serial number

## Box B

Part name	A	B	B1	B2	B3	B4	B5
Qty	4	2	2	2	2	2	2
Part name	B6	B7	D	F	F1	D1	D2
Qty	2	2	4	4	4	4	2
Part name	G1						
Qty	2						





# ASSEMBLY

## Instruction

	A x4
	B x2
	B1 x2
	B2 x2
	B3 x2
	B4 x2
	B5 x2
	B6 x2
	B7 x2
	C x4
	C1 x4
	D x4
	D1 x4
	D2 x4
 	D3 x2

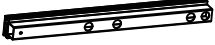
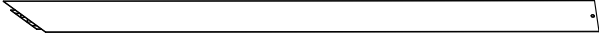
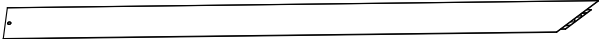
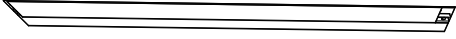
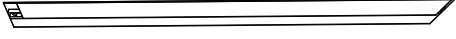
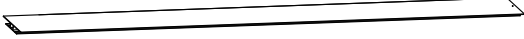
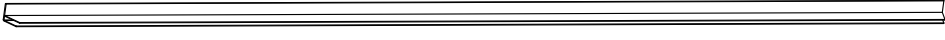
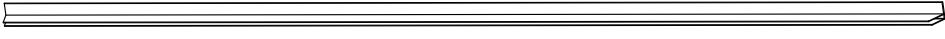
# ASSEMBLY

## Instruction

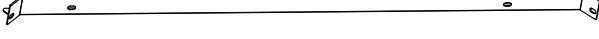
	D4 x4
	E x4
	E1 x4
	E2 x4
	E3 x4
	E4 x2
	F x4
	F1 x4
	F2 x2
	F3 x2
	F4 x2
	G x4
	G1 x2

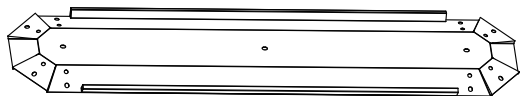
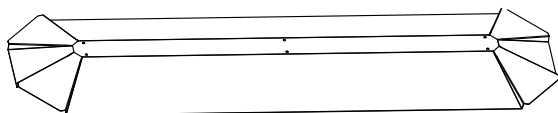
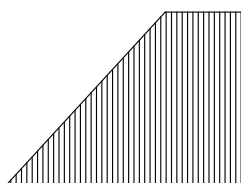
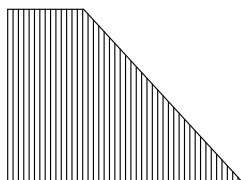
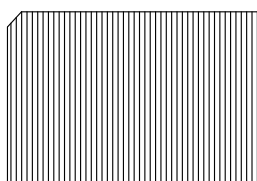
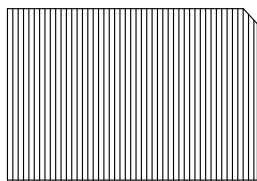
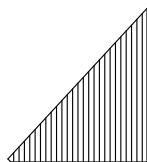
**H** x1**H1** x1**I** x2**J** x4**J1** x4**J2** x4**J3** x4**K** x4

# ASSEMBLY

## Instruction

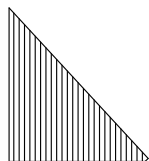

K1 x4

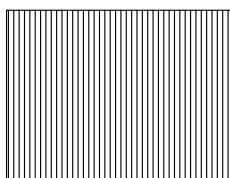

K2 x4

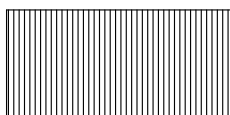

K3 x2

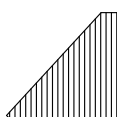

L x2

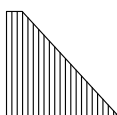

L1 x2

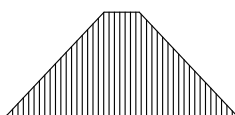

L2 x2



M x4

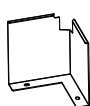











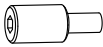

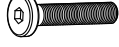
N x4



N1 x4

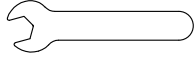

		T1 x1
		U x80
 $\varnothing 11 * \varnothing 6 * 20\text{mm}$		U1 x8
		V x32
 M6 * 15 mm		W x128
 M6 * 20mm		W1 x20
 M6 * 35 mm		X x8
 M4 * 12 mm		X1 x16
 ST4.8* 12 mm		Y x12
 M6		Y2 x3
		Z x12
		Z1 x1
		Z2 x1
		Z3 x1

No.	Qty	Picture	No.	Qty	Picture
A	4		W	12	 M6 * 15 mm
R	4				

### Step1

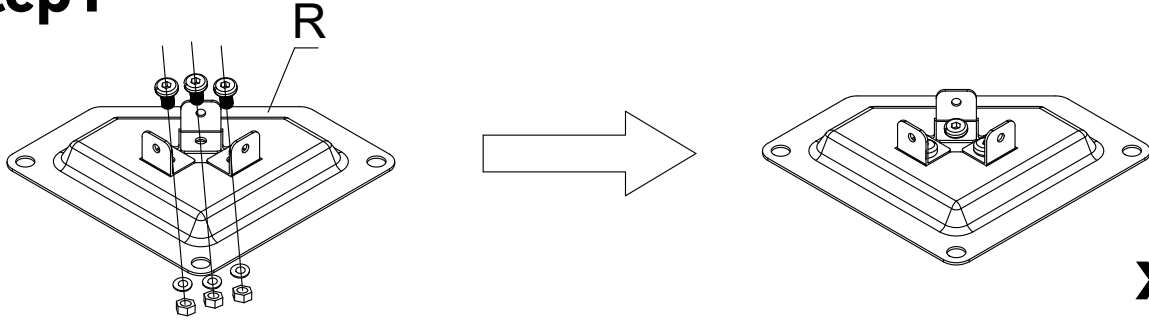

### Step2

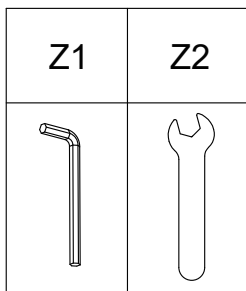
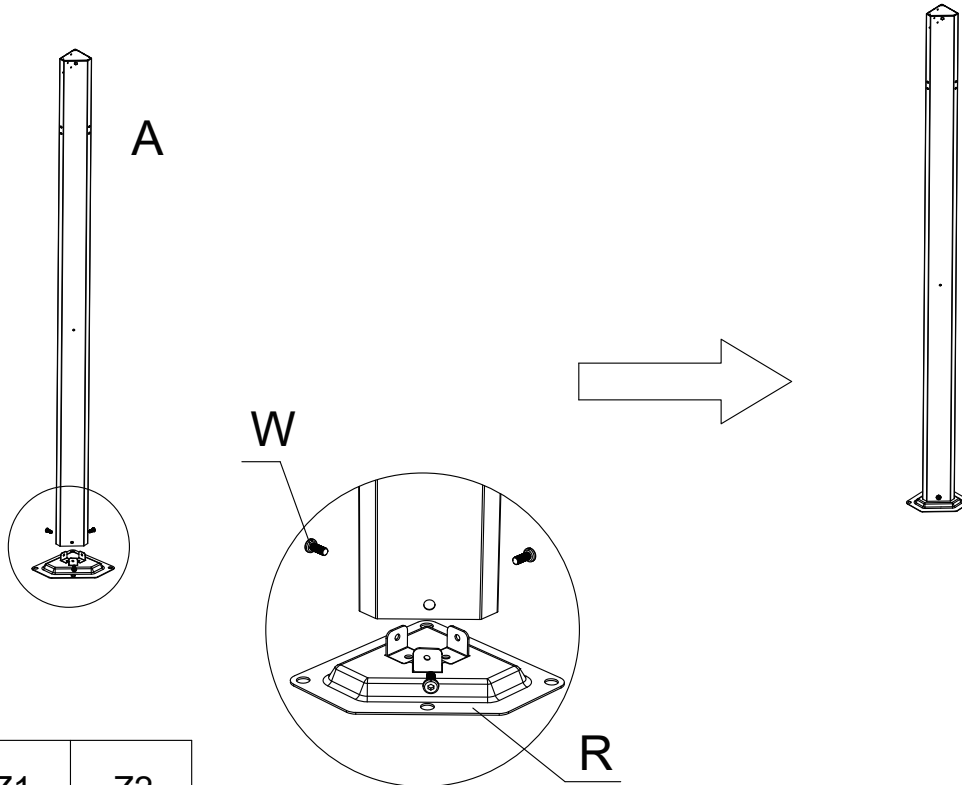

**4pcs**

No.	Qty	Picture	No.	Qty	Picture
B	2		B1	2	
B2	2		B3	2	
B4	2		B5	2	
B6	2		B7	2	
W	16	M6 * 15 mm			

### Step3

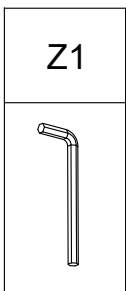
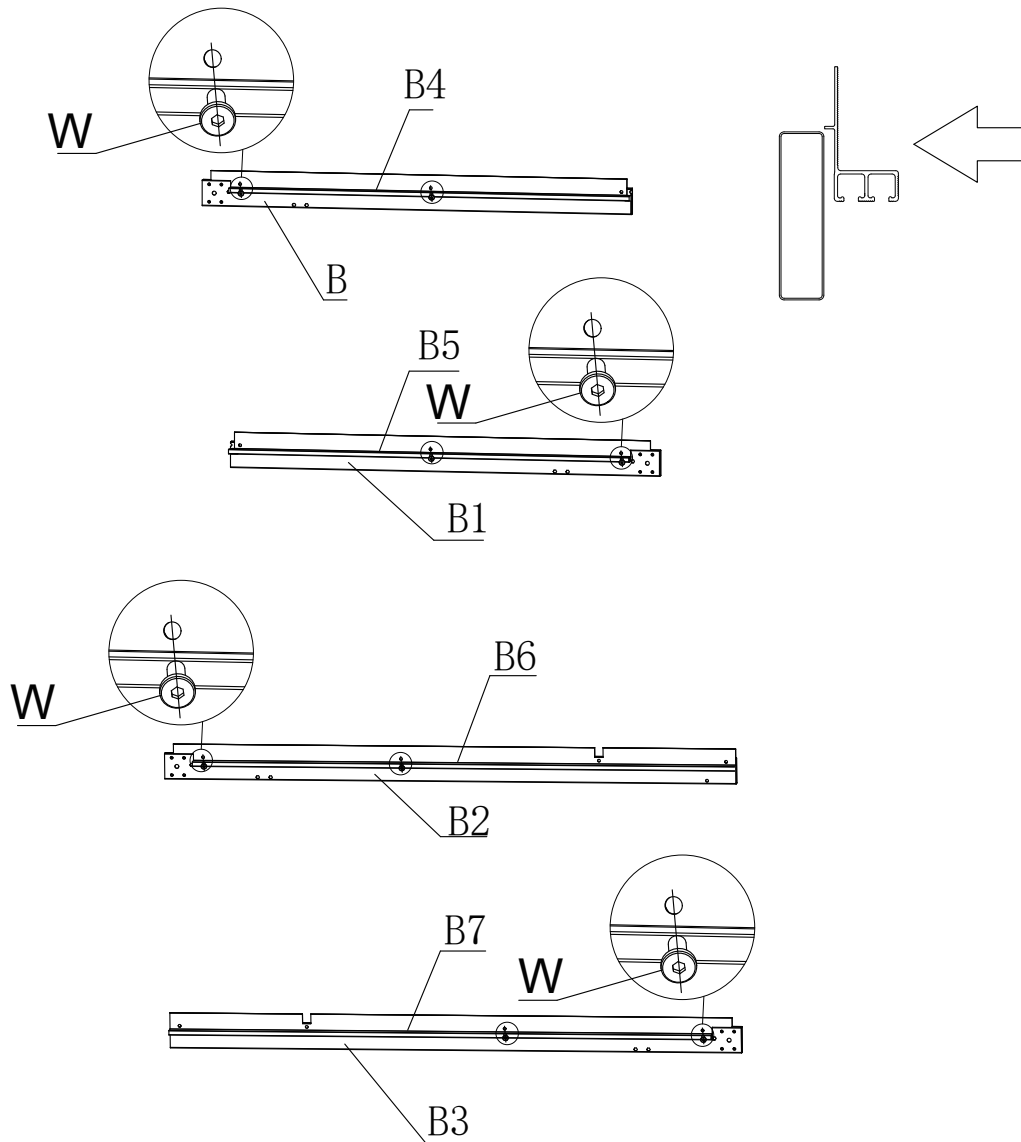

**x2**

No.	Qty	Picture	No.	Qty	Picture
B	2		B1	2	
B2	2		B3	2	
W	40	M6 * 15 mm	M	4	

### Step4

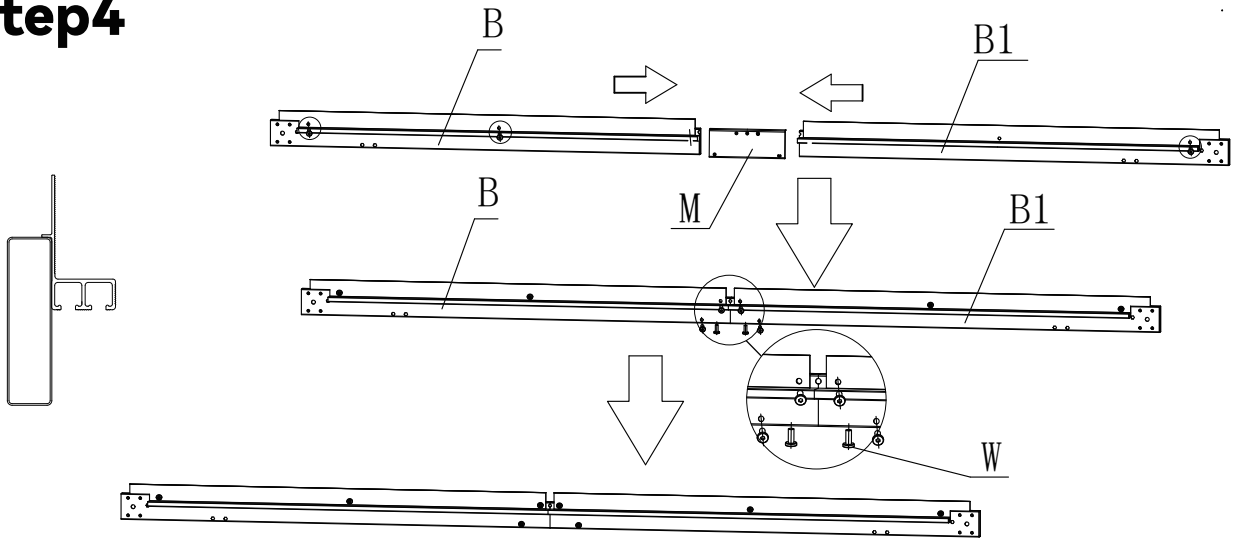

**x2**

### Step5

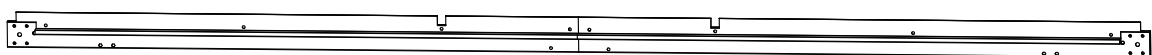
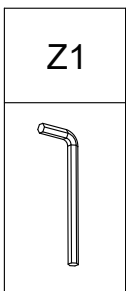
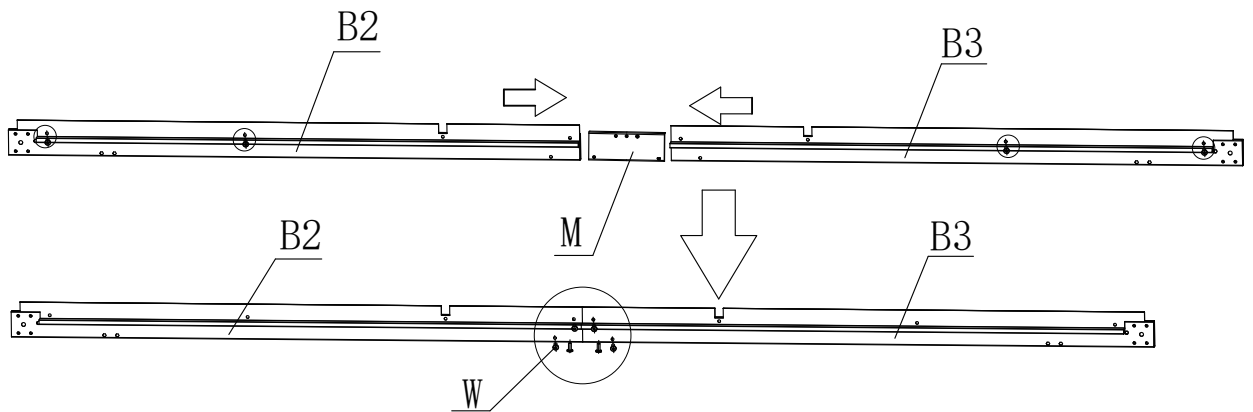

**x2**

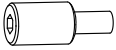
No.	Qty	Picture	No.	Qty	Picture
V	32				

## Step 6

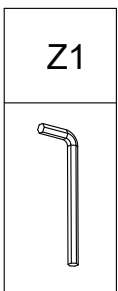
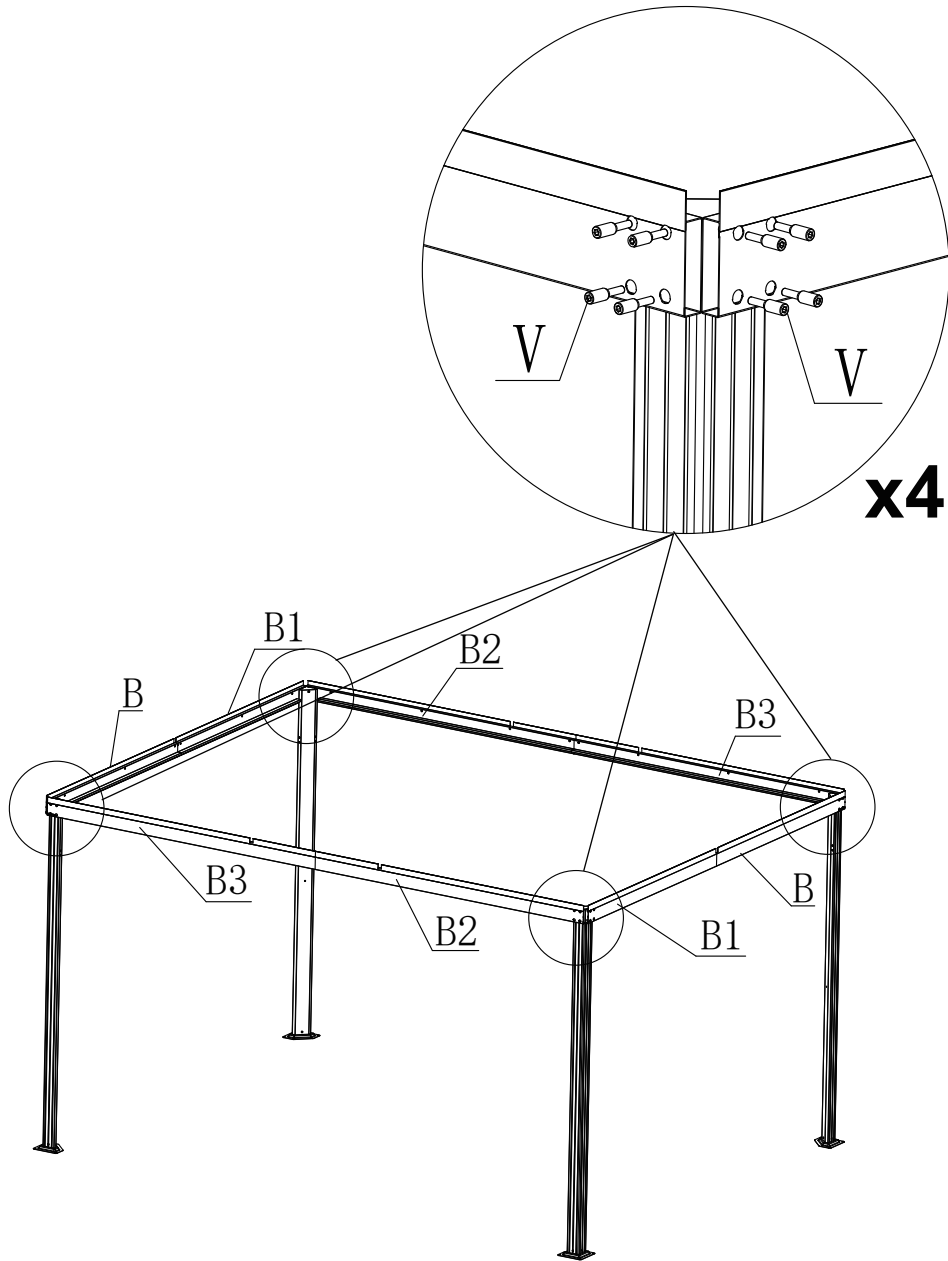

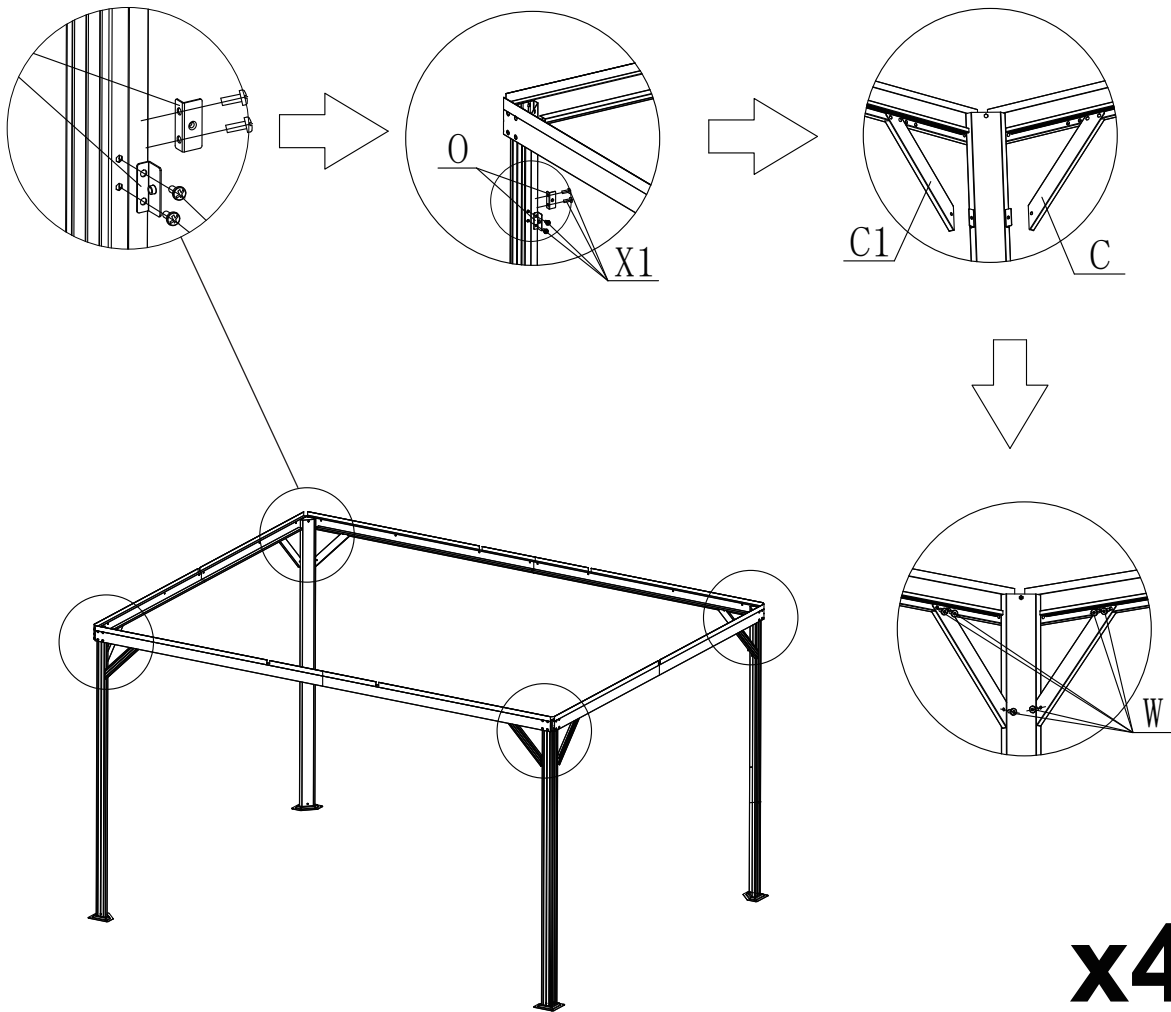

No.	Qty	Picture	No.	Qty	Picture
C	4		W	24	
C1	4		O	8	
			X1	16	

## Step 7





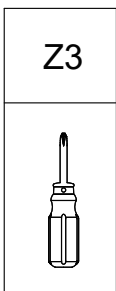
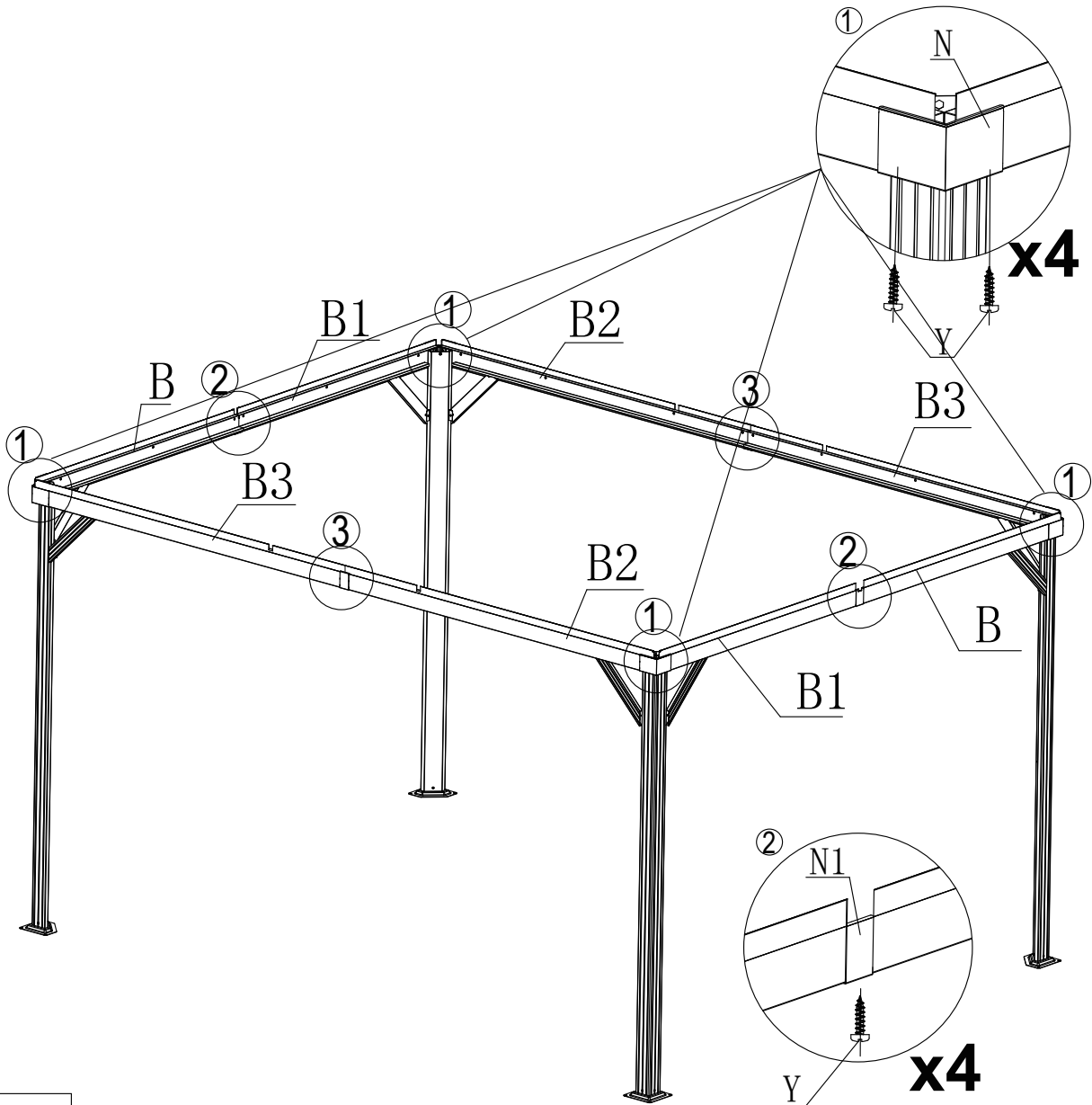

Z1	Z3

No.	Qty	Picture	No.	Qty	Picture
N	4		Y	12	 ST4.8* 12 mm
N1	4				

## Step8



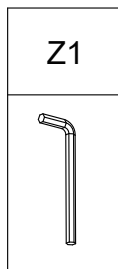
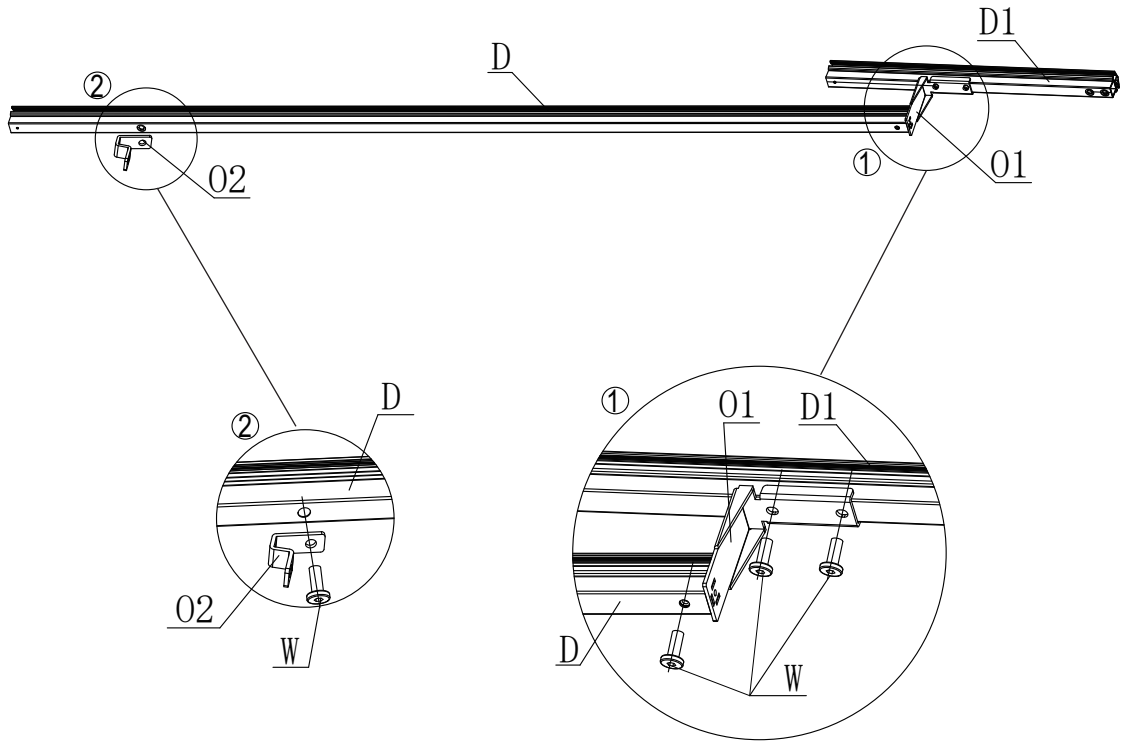

No.	Qty	Picture	No.	Qty	Picture
D	4		W	16	
D1	4		O1	4	
O2	4				

## Step9

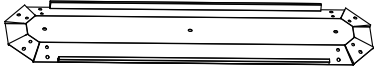

**x4**

No.	Qty	Picture	No.	Qty	Picture
H	1		W	12	 M6 * 15 mm

## Step10

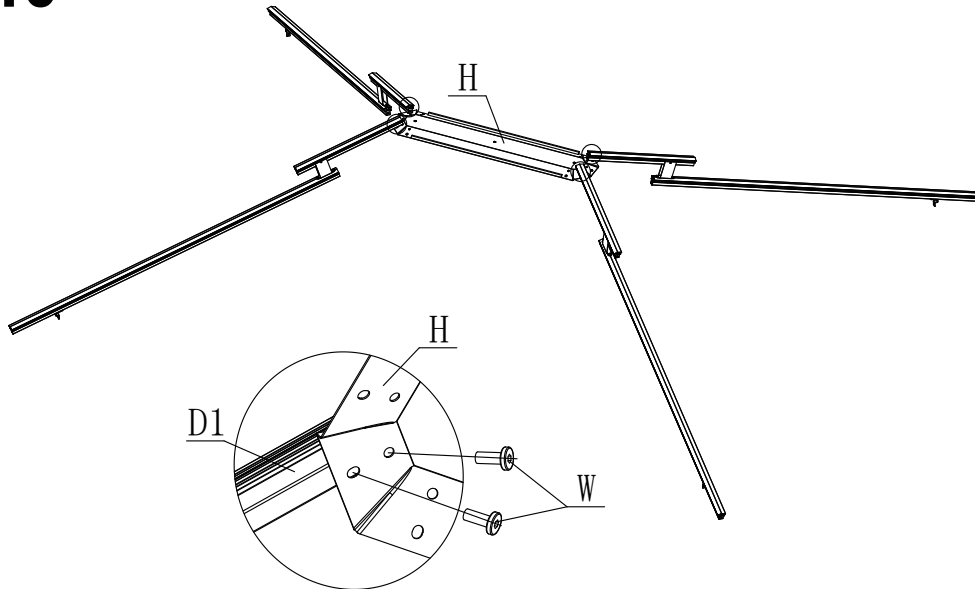



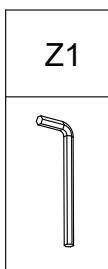
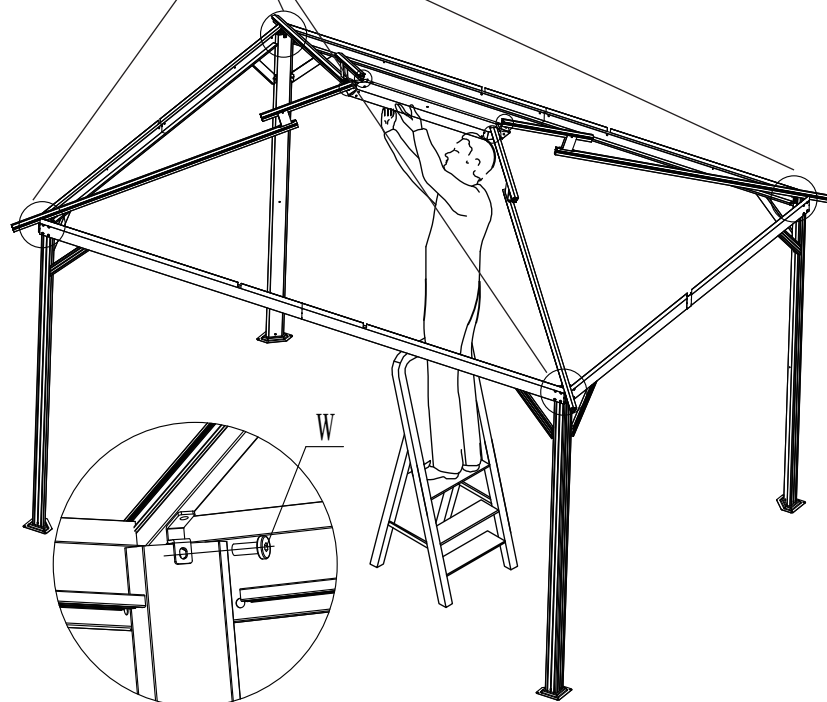

## Step11



Note:

1. Have one person stand on the ladder to lift and hold "H" while others fasten the screws of "V"
2. Do not release "H" until all the "V" screws are fully tightened.

No.	Qty	Picture	No.	Qty	Picture
D2	4		W	16	 M6 * 15 mm
D4	4		O1	4	
O3	4				

## Step12

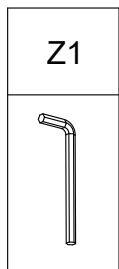

No.

Qty

Picture

W

12

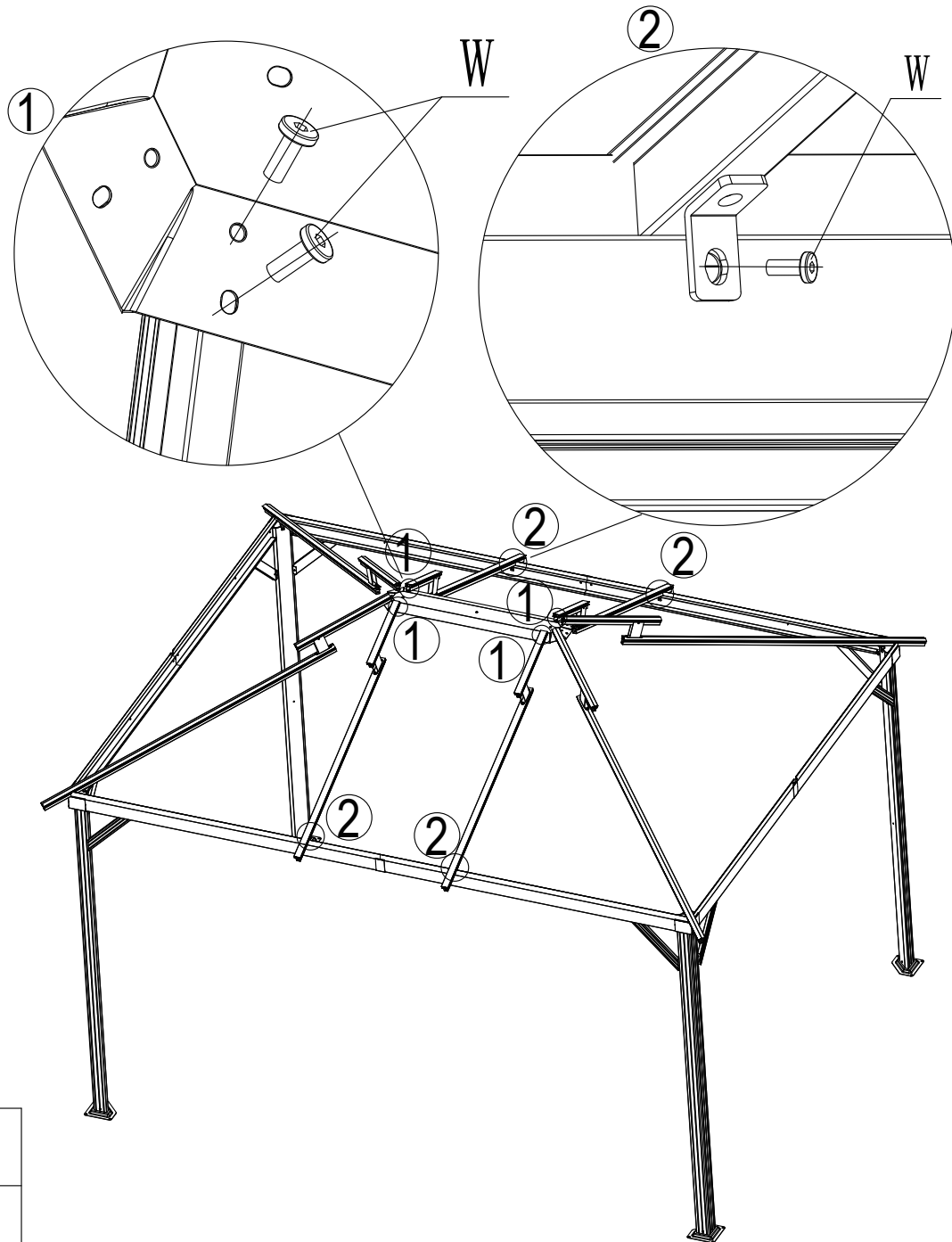

M 15 mm

# Step13







Z1

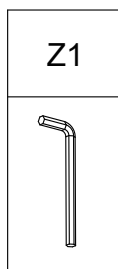
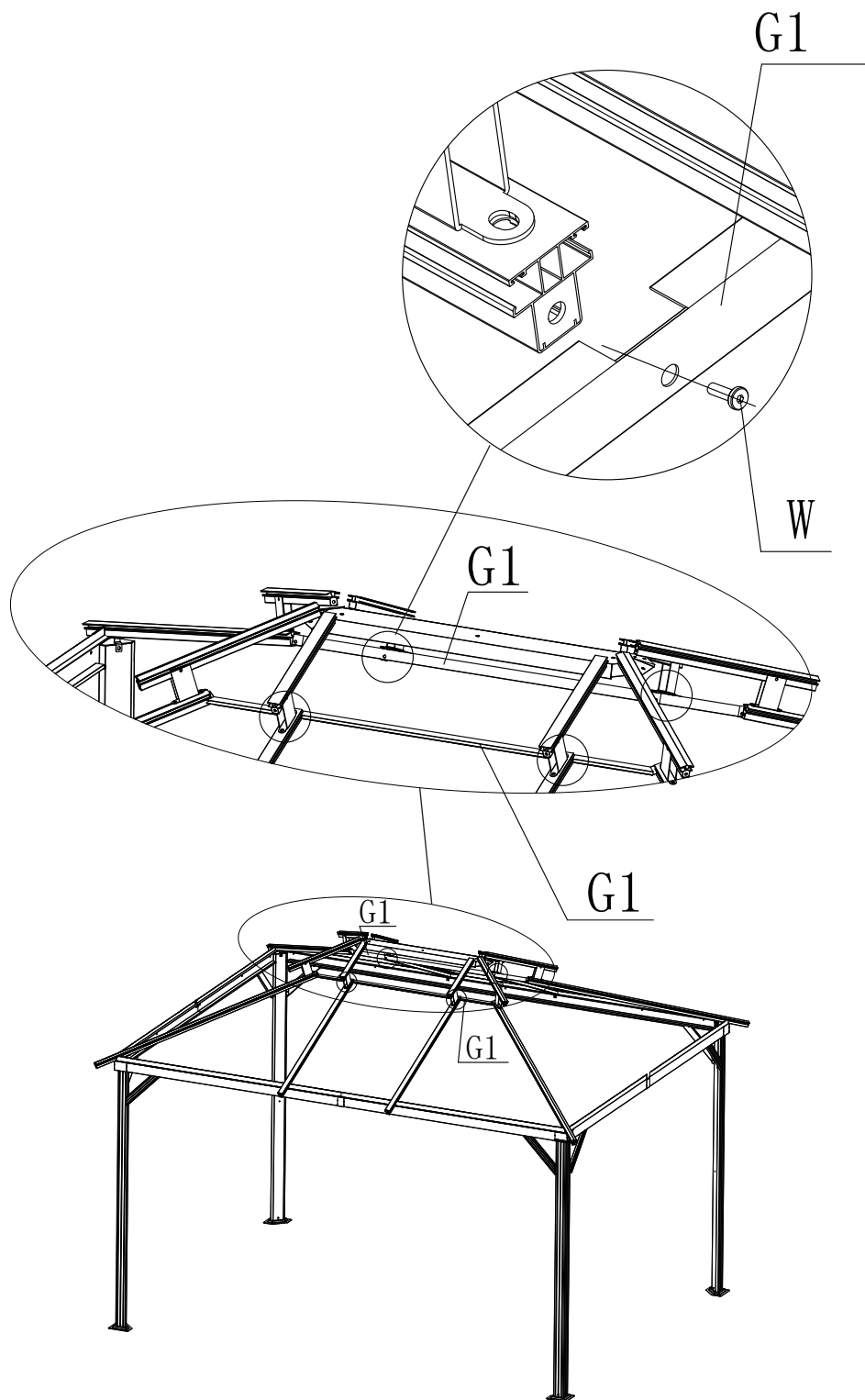

No.	Qty	Picture	No.	Qty	Picture
G1	2		W	4	 M6 * 15 mm

## Step14



No.	Qty	Picture	No.	Qty	Picture
D3	2		W	4	 M6 * 15 mm
I	2		O3	2	

## Step15

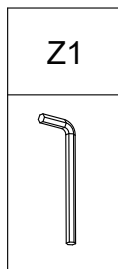
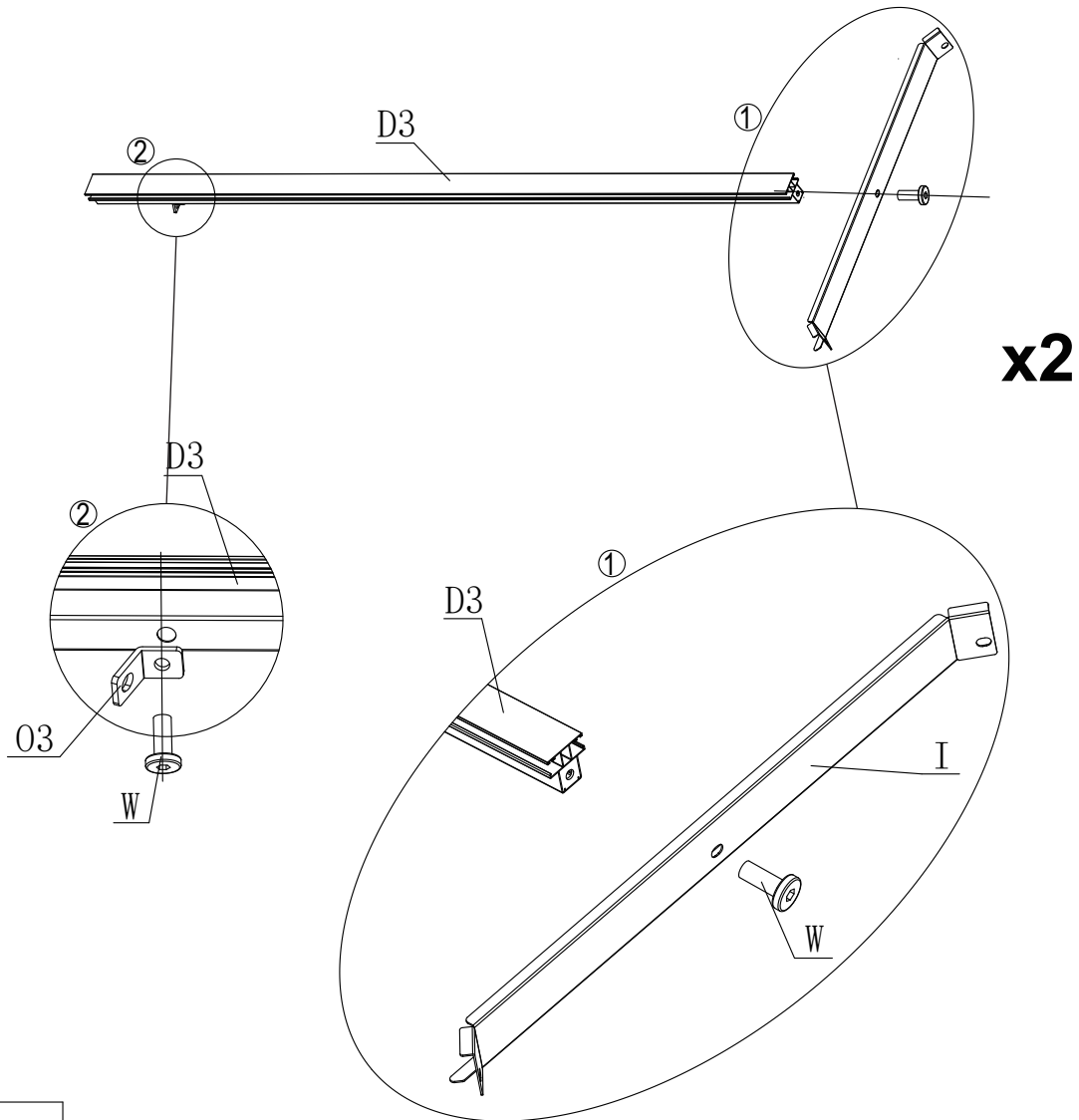

No.

Qty

Picture

W

6

 M6 \* 15 mm

# Step16

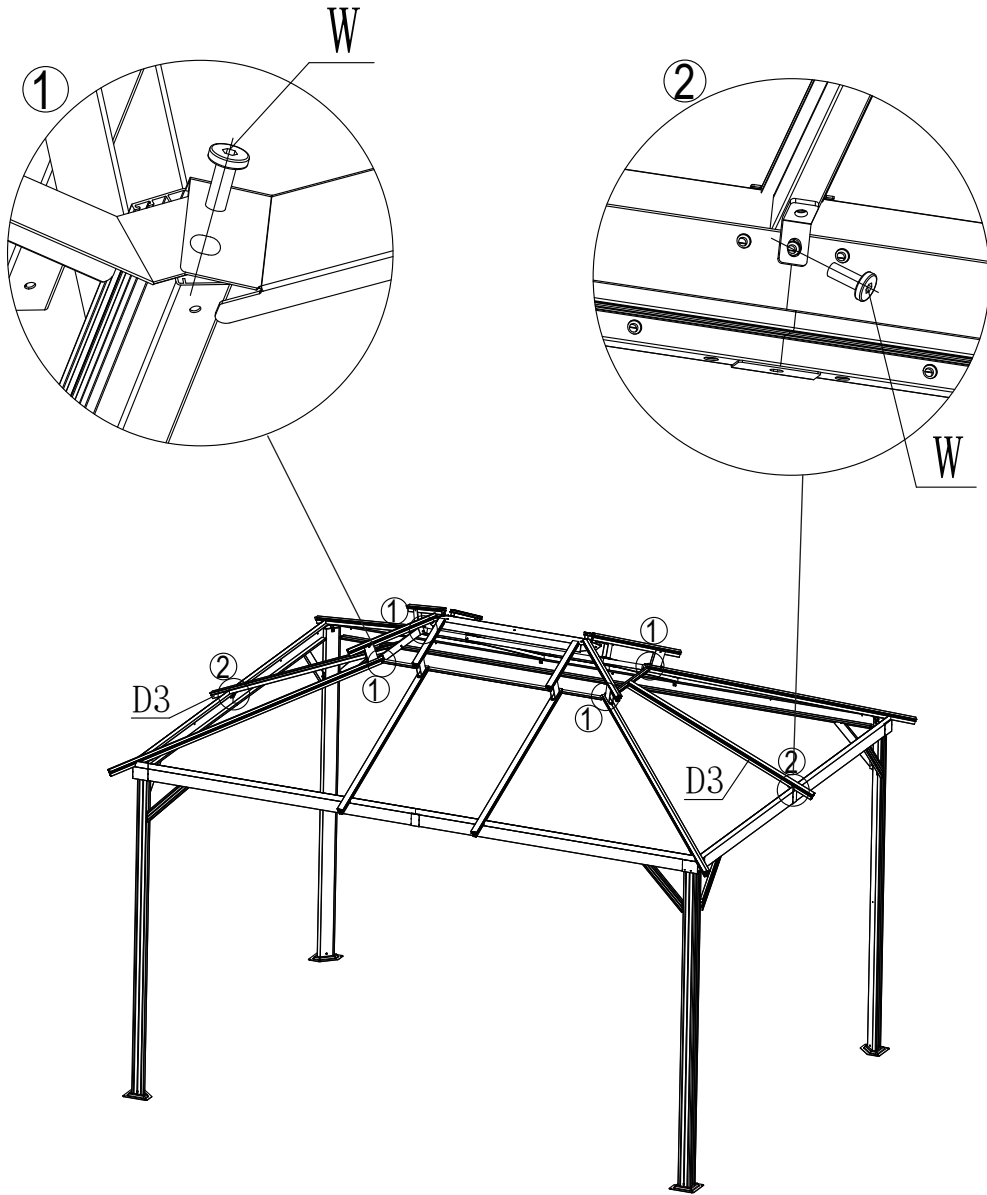





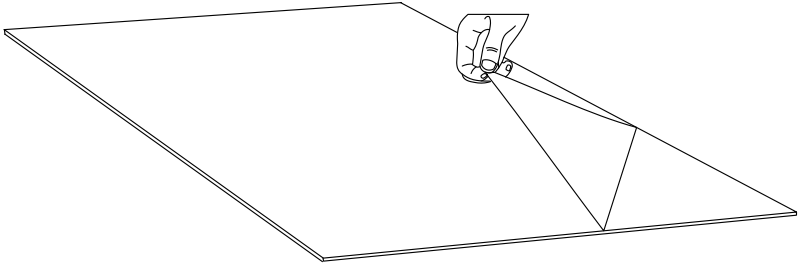
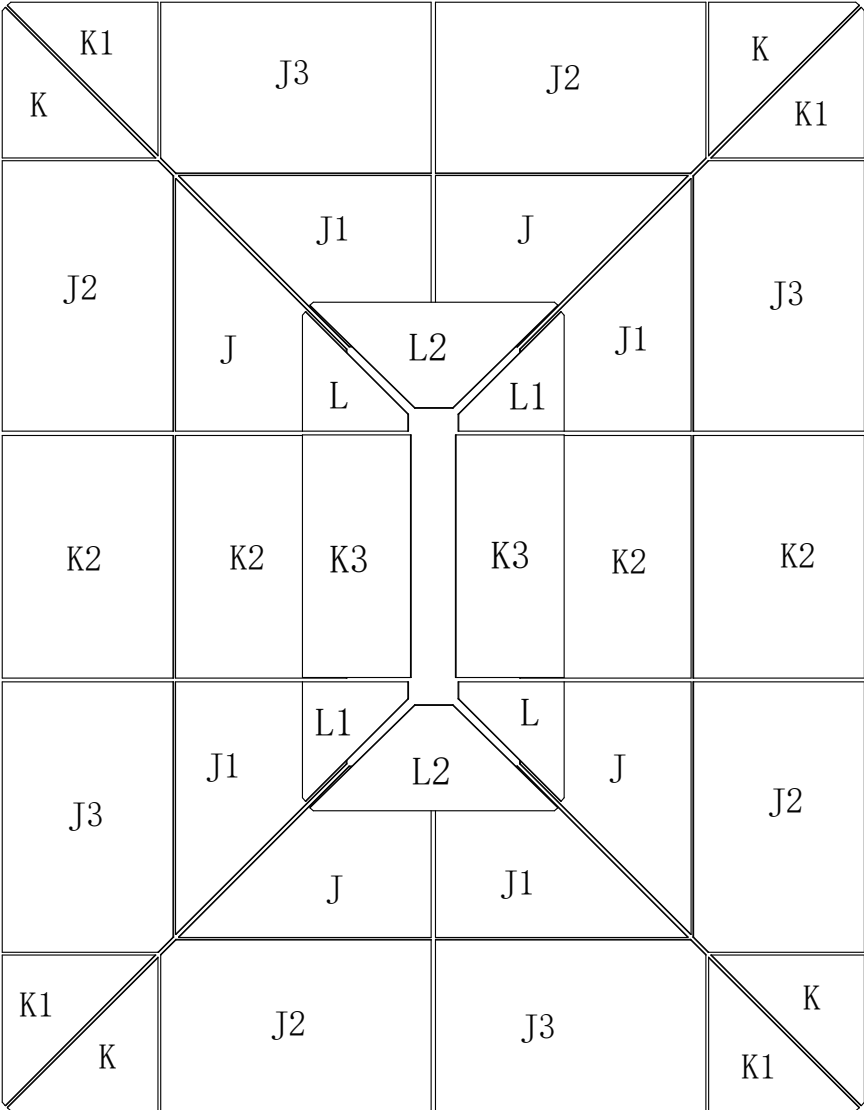

Z1

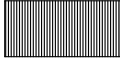

# Step 17





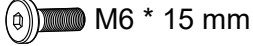

Remove the protective film before installation.

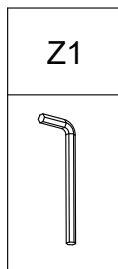
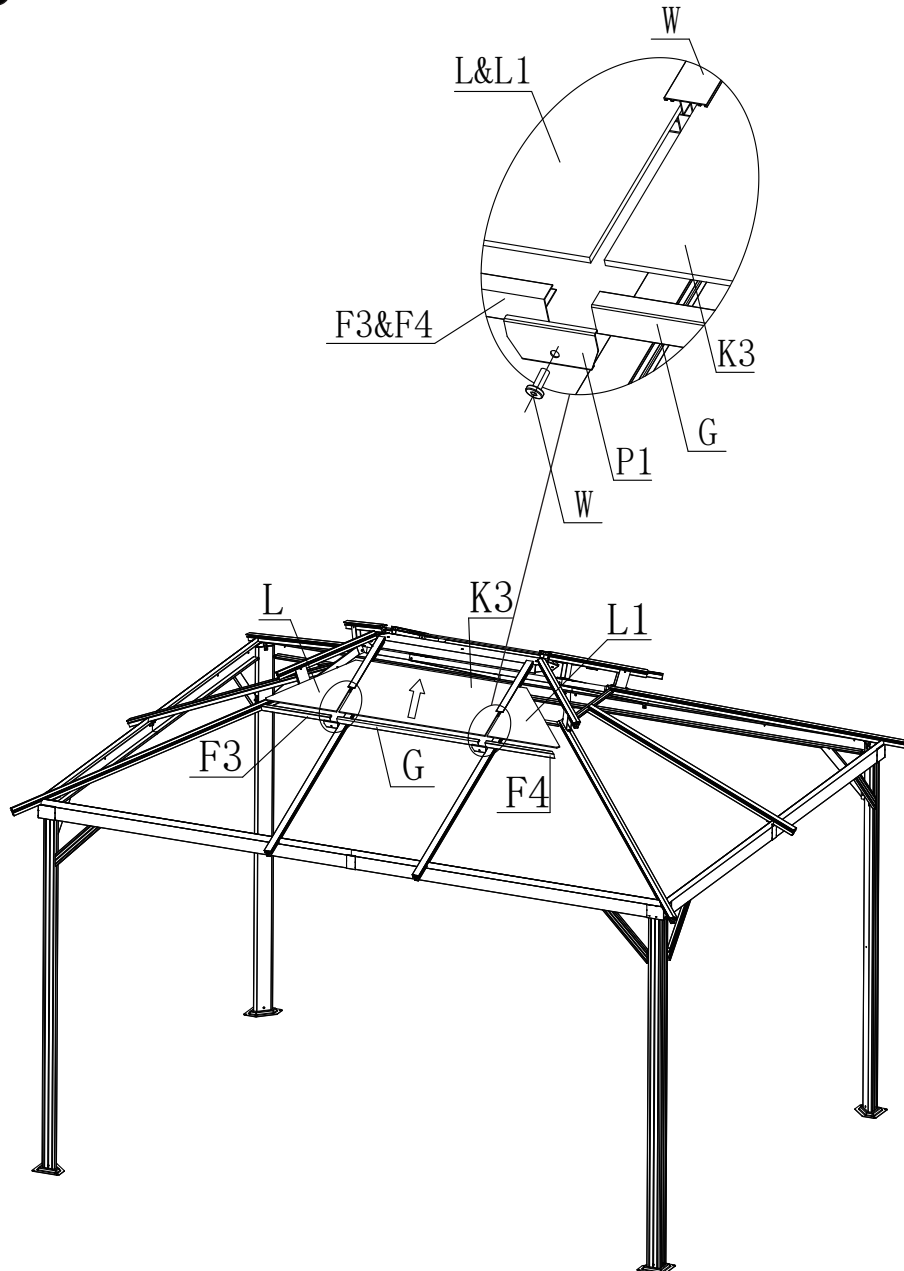
No.	Qty	Picture	No.	Qty	Picture
K3	2		L	2	
L1	2		F3	2	
F4	2		G	2	
P1	4		W	4	 M6 * 15 mm

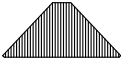
## Step18





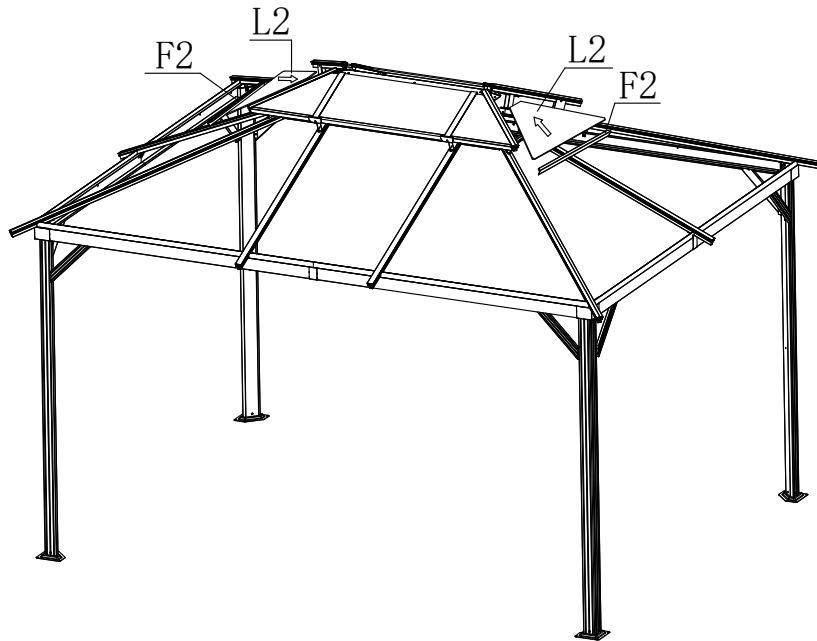

No.	Qty	Picture	No.	Qty	Picture
L2	2		P	4	
F2	2		W	4	 M6 * 15 mm

## Step19

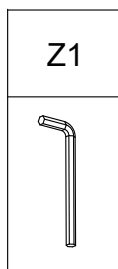
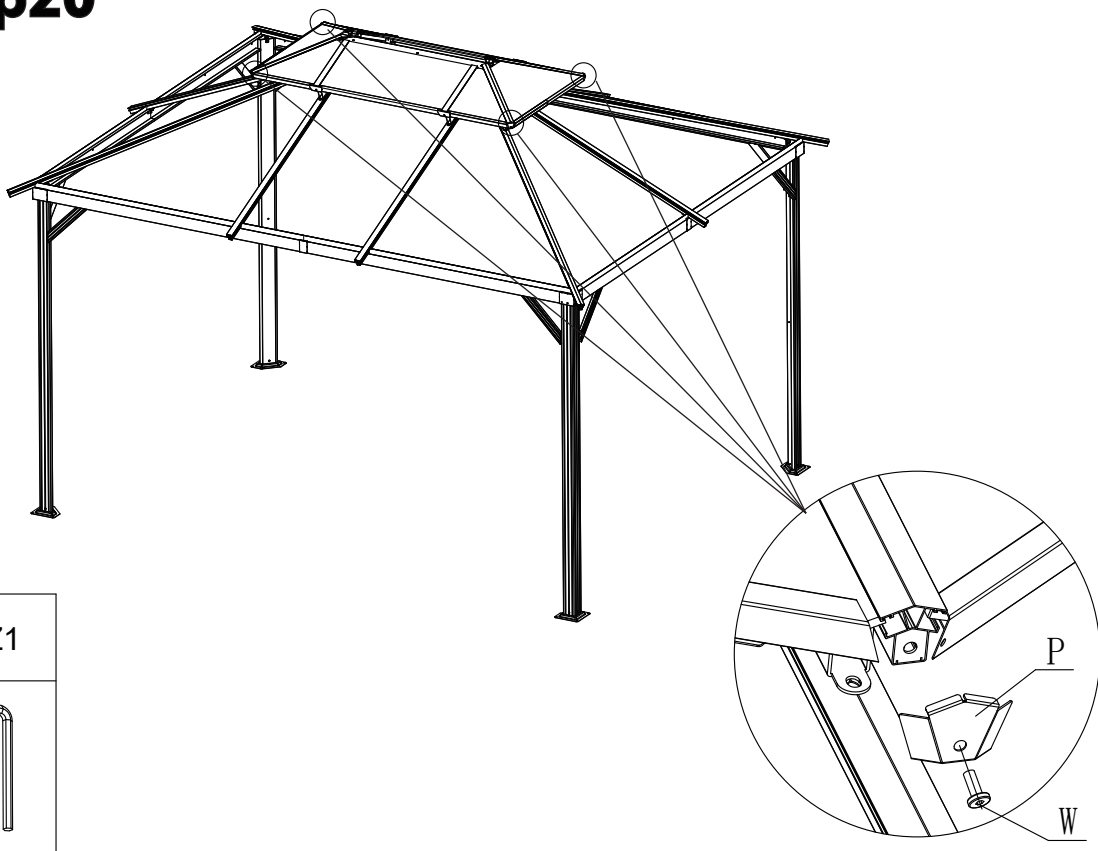

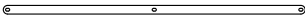

## Step20

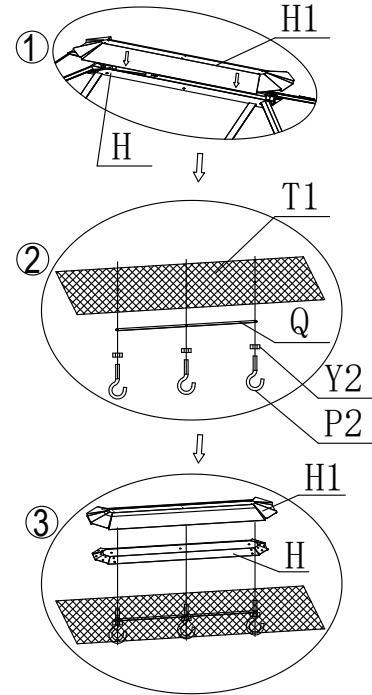
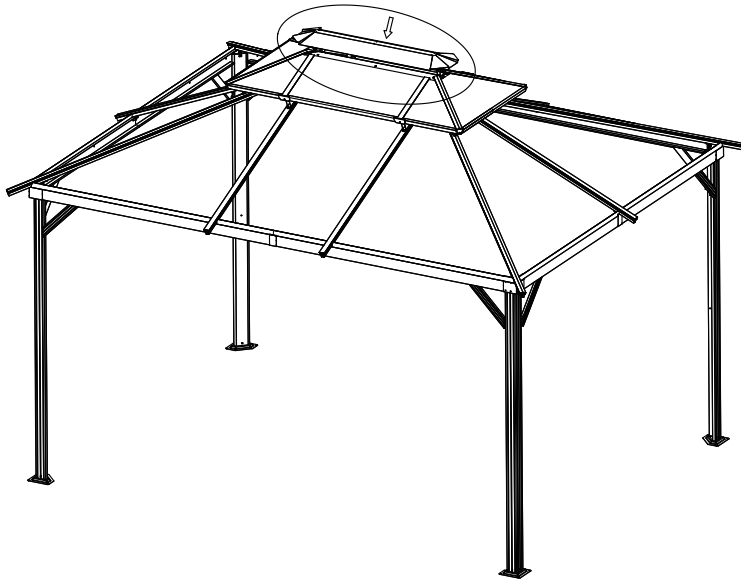

No.	Qty	Picture	No.	Qty	Picture
H1	1		T1	1	
Q	1		P2	3	
Y2	3	 M6			

## Step21



No.	Qty	Picture	No.	Qty	Picture
Q1	8		Q2	2	

## Step22

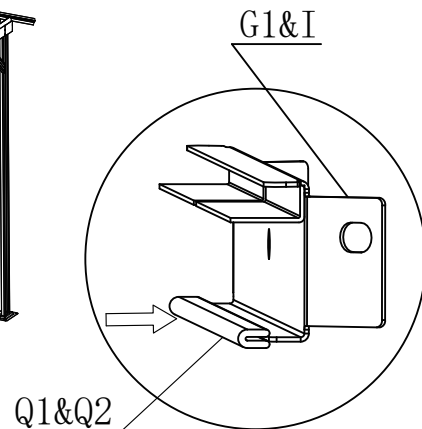
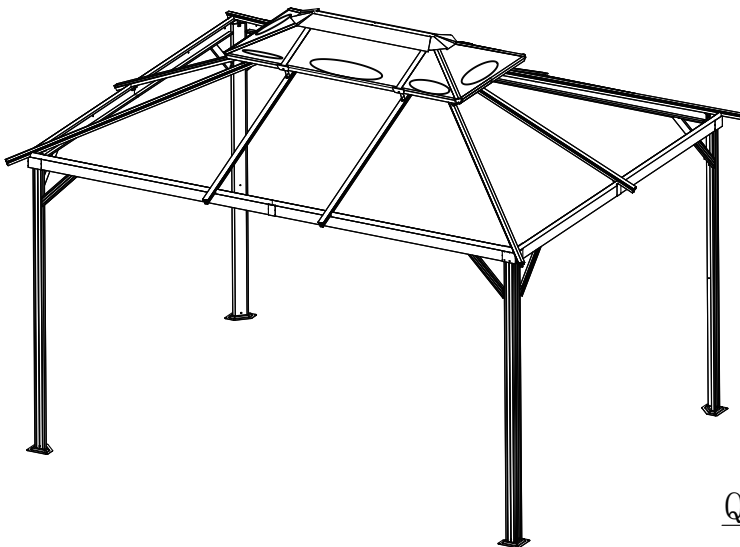

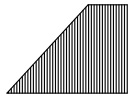
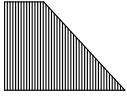
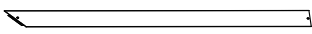
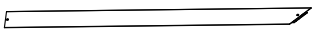
No.	Qty	Picture	No.	Qty	Picture
J	4		J1	4	
E	4		E1	4	

## Step23

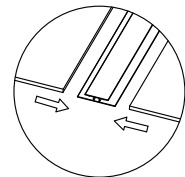
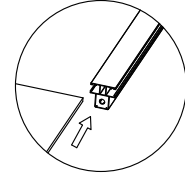
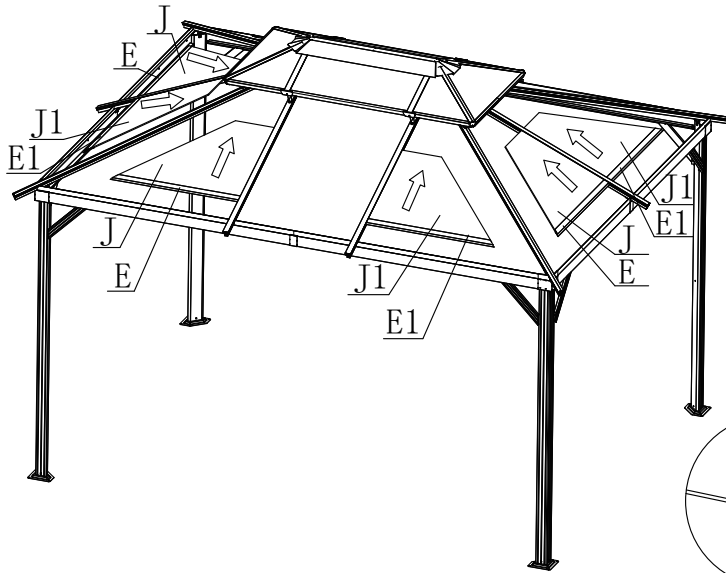

Refer to diagram install the E/E1  
Narrow side top ↑ / Wide side base ↓

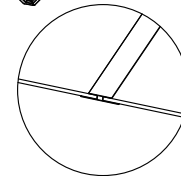

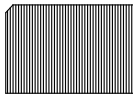
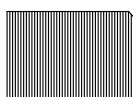

No.	Qty	Picture	No.	Qty	Picture
J2	4		J3	4	

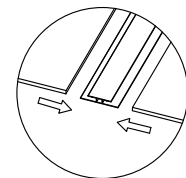
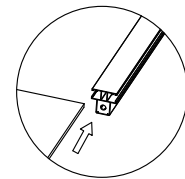
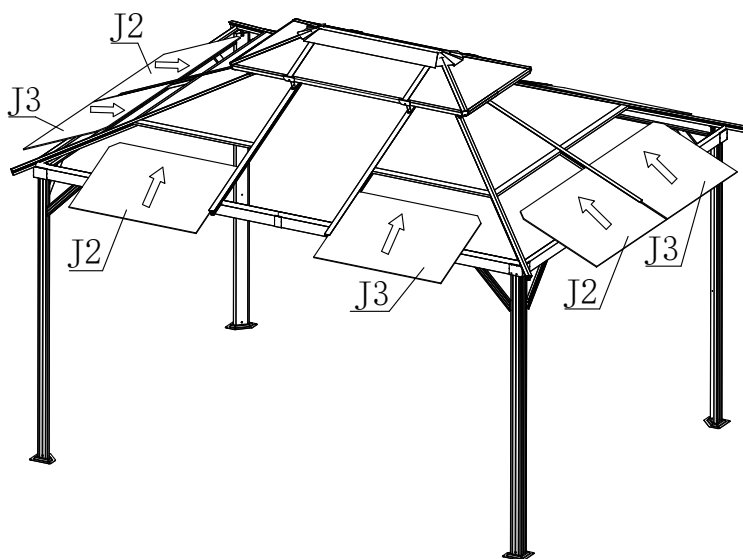
## Step24



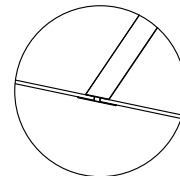

Refer to diagram install the E/E1  
Narrow side top ↑ / Wide side base ↓

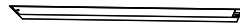
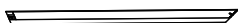

No.	Qty	Picture	No.	Qty	Picture
K	4		K1	4	
E2	4		E3	4	

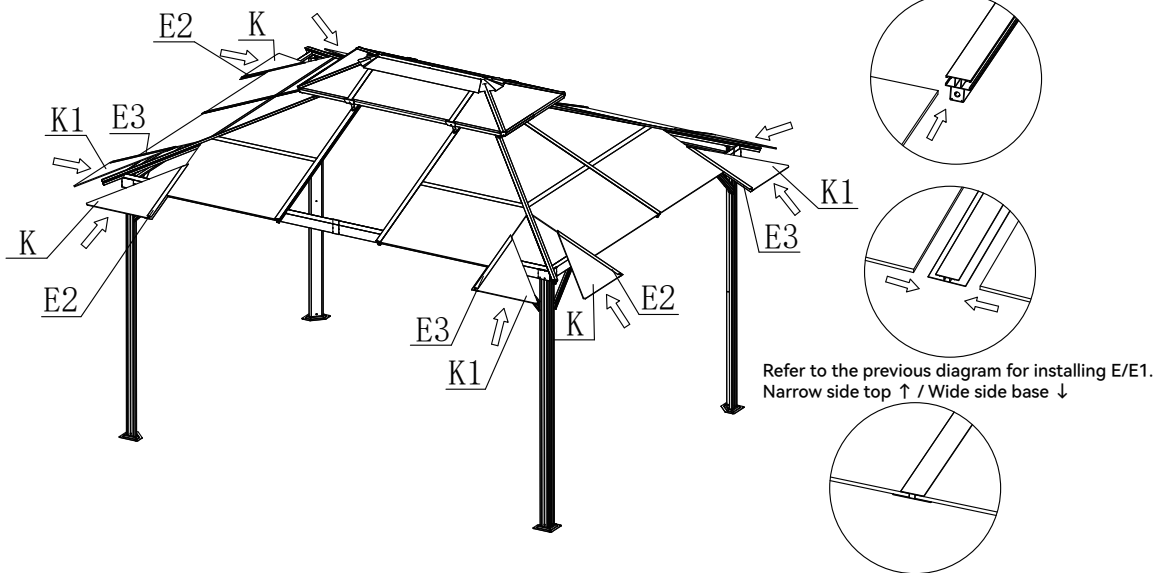

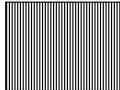
## Step25



No.	Qty	Picture	No.	Qty	Picture
K2	4		E4	2	

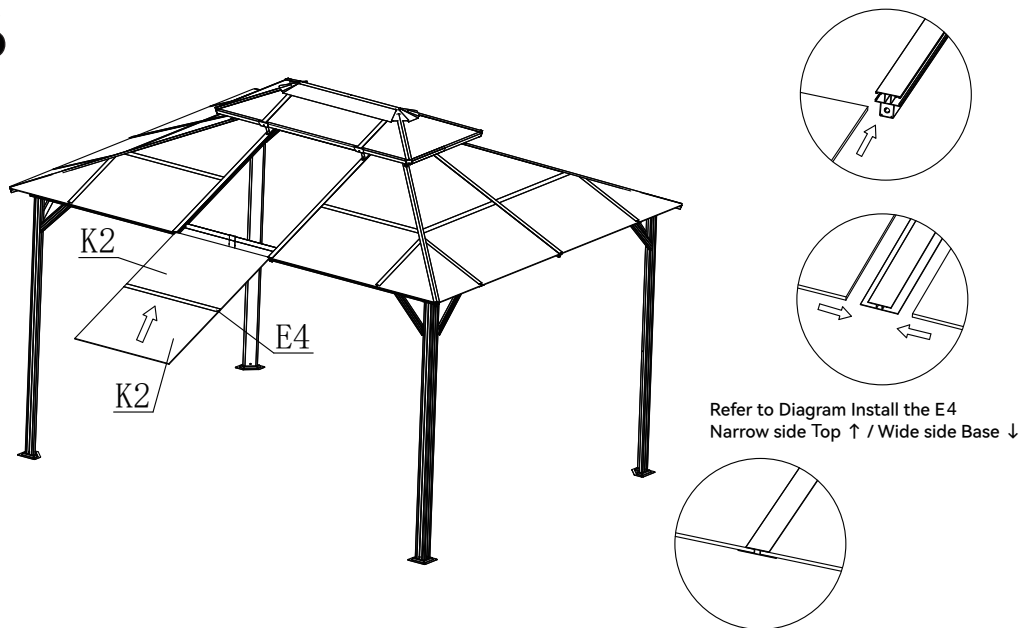

## Step26

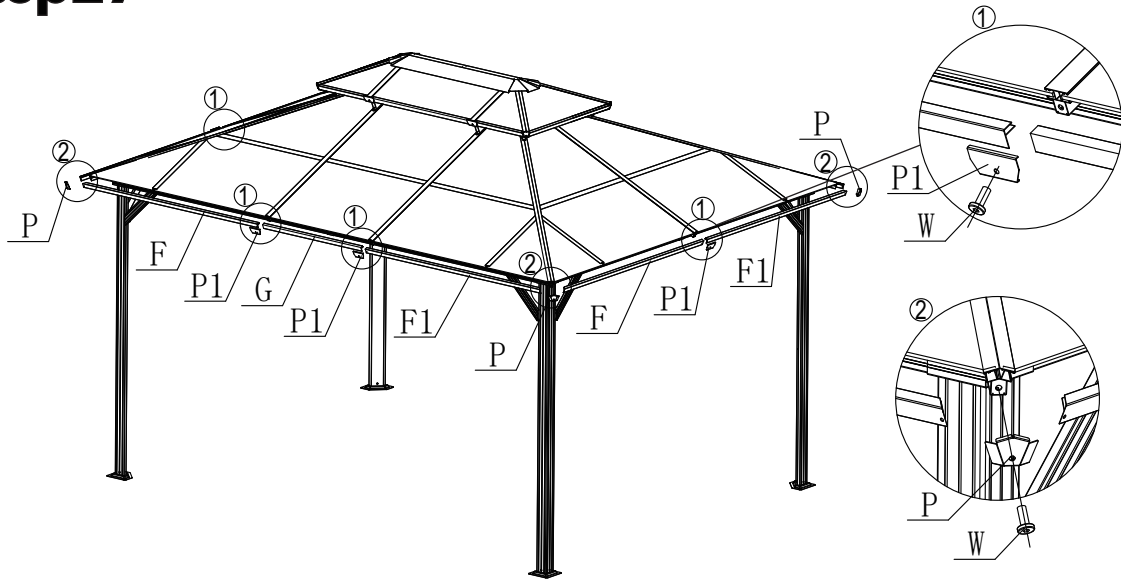

No.	Qty	Picture	No.	Qty	Picture
F	4		P	4	
F1	4		P1	6	
G	2		W	10	 M6 * 15 mm

## Step27



No.	Qty	Picture	No.	Qty	Picture
U	80		U1	8	 Ø11 * Ø 6* 20mm
X	8	 M6 * 35 mm			

## Step28

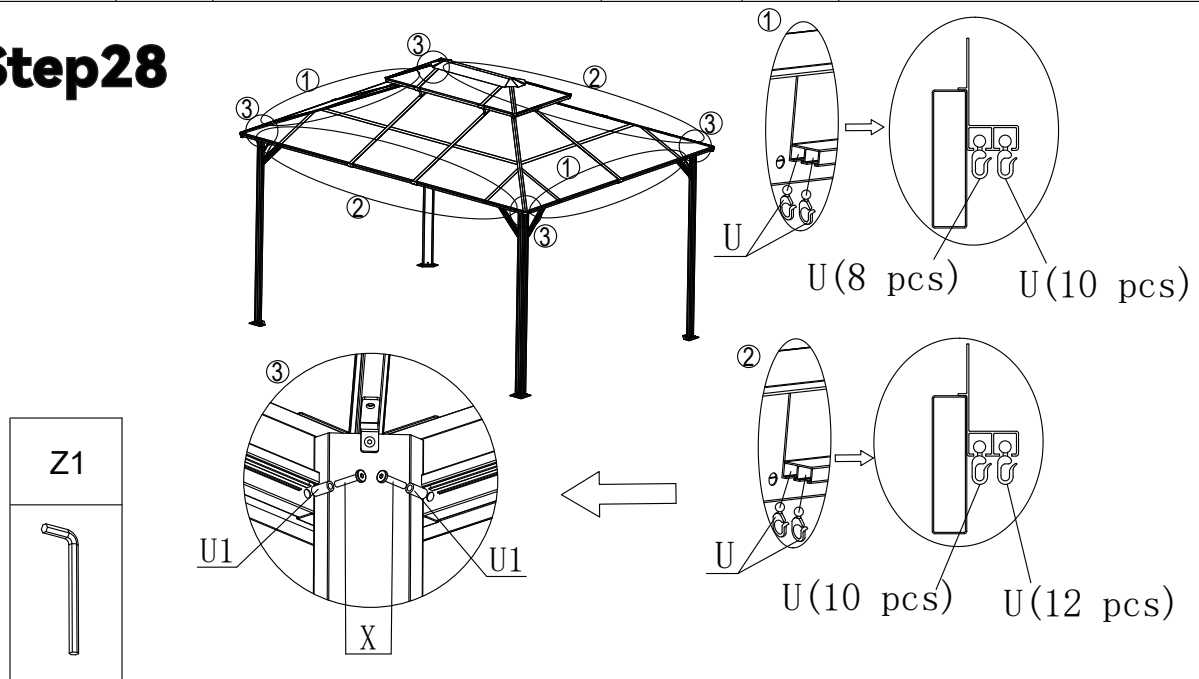

No.	Qty	Picture
S	4	 Curtain

## Step29

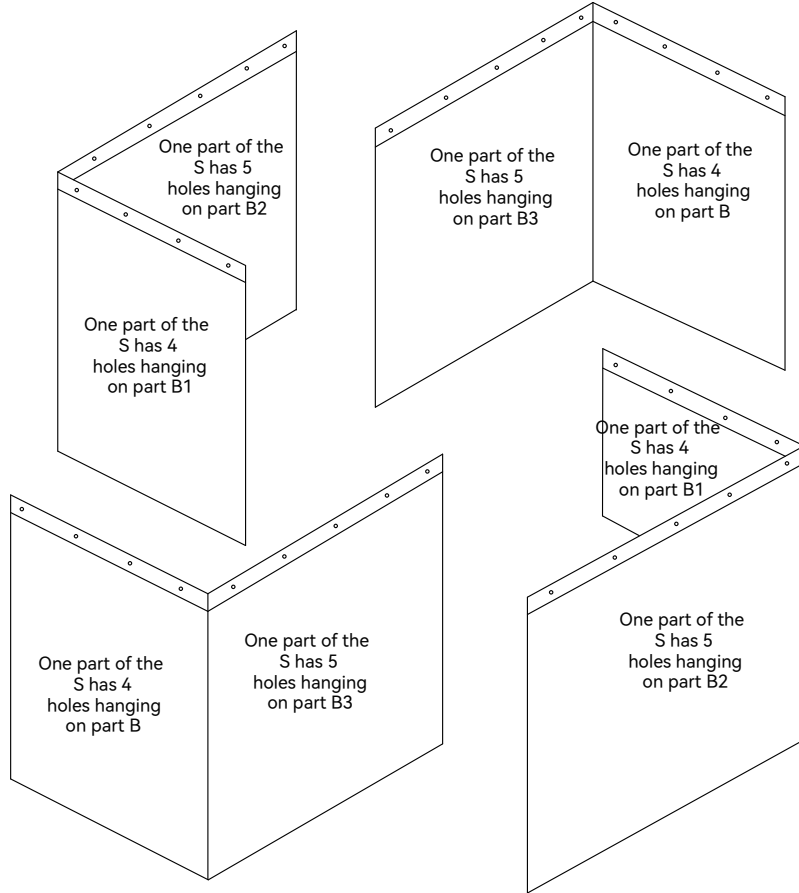

## Step30

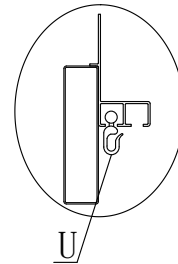
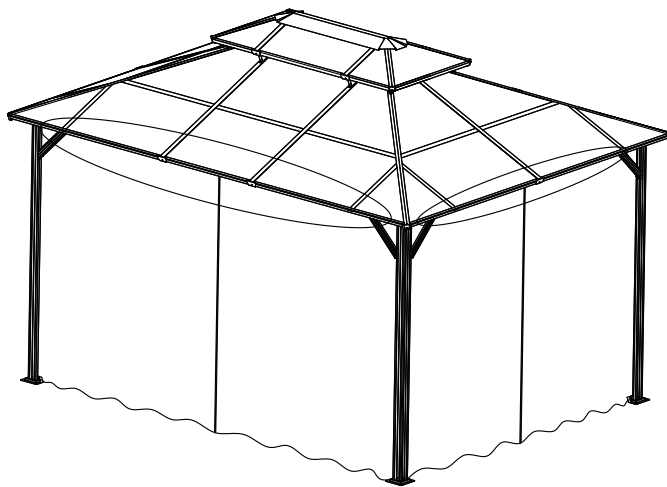

Pay attention to the sidewall curtain's installation position.

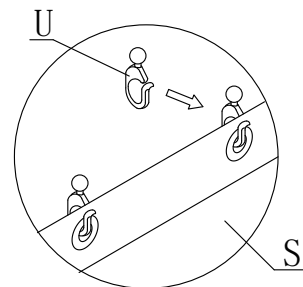

No.

Qty

Picture

T

4



Net

### Step31

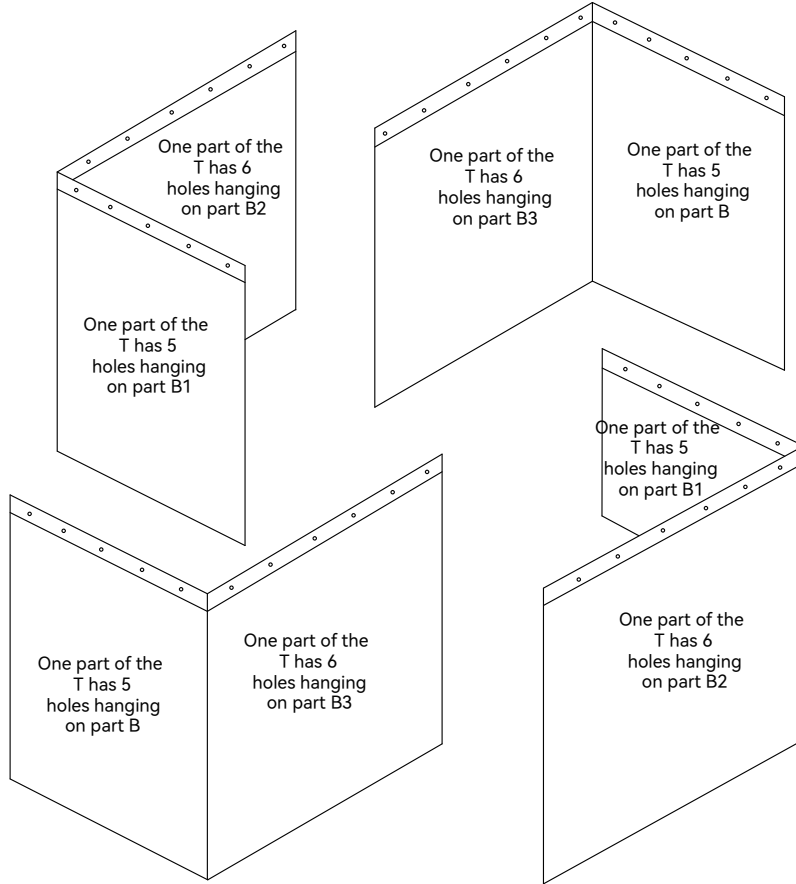

### Step32

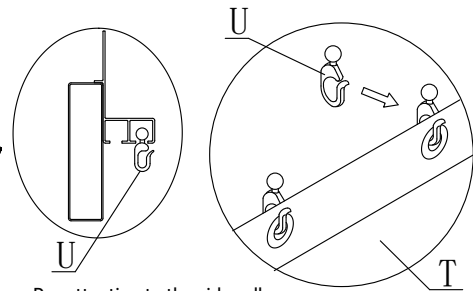
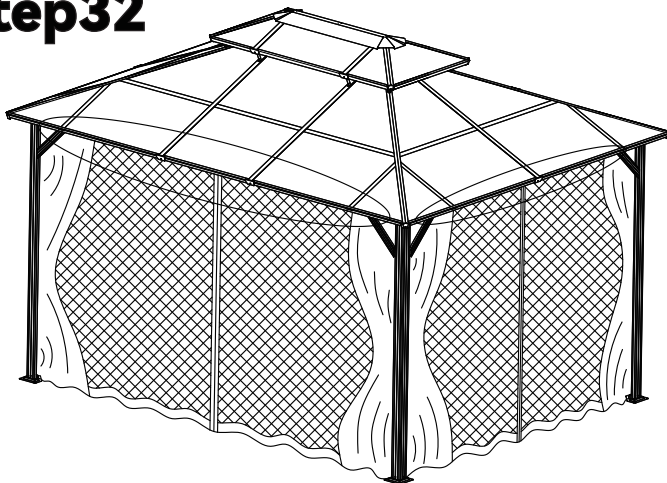

Pay attention to the sidewall netting's installation position.

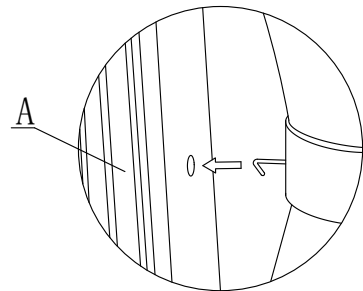

Hang the hook attached to the netting on Part A.

No.	Qty	Picture
Z	12	

## Step33

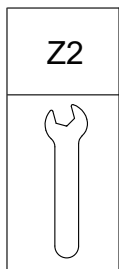
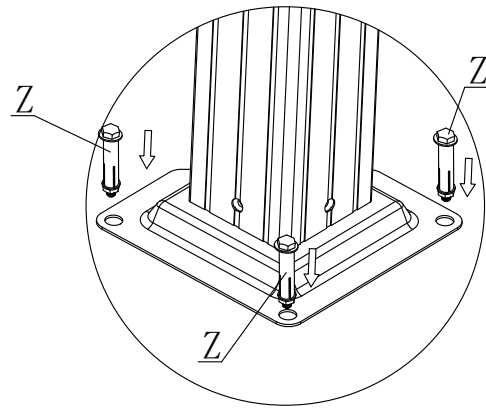
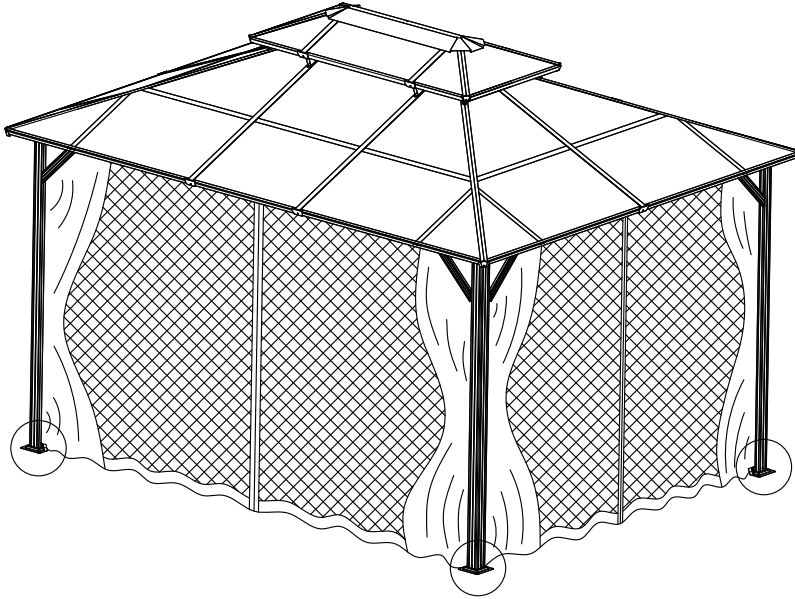

# EROMMY!

Closer to Life!

