

## IMPORTANT SAFETY INSTRUCTIONS

Please read and understand this entire manual before attempting to assemble, install or operate the product.

### WARNING:

Disconnect power by turning off the circuit breaker or by removing the fuse at the fuse box. (All electrical steps should be performed by a qualified person or electrician.)

Ensure wiring and outlet box are compliant with national and local electrical codes, including the NEC. SkyOutlet requires installation on the branch circuit solid 12 or 14 AWG wire.

### CAUTION:

To reduce risk of fire, use Eight (8) E26 **Max 60-watt** incandescent G45 bulbs or CFL/LED equivalent(not included). This fixture is meant for indoor use, **SUITABLE FOR DRY LOCATIONS AND DAMP LOCATIONS.**

### TOOL NEEDED:(NOT PROVIDED)

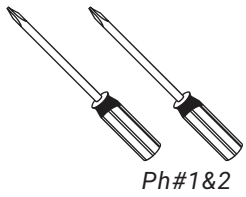

Ph#1&2



Safety Glasses



Step Ladder

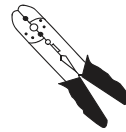

Wire Stripper



Pliers

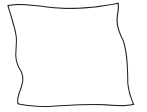

Soft Cloth

## PACKAGE CONTENT

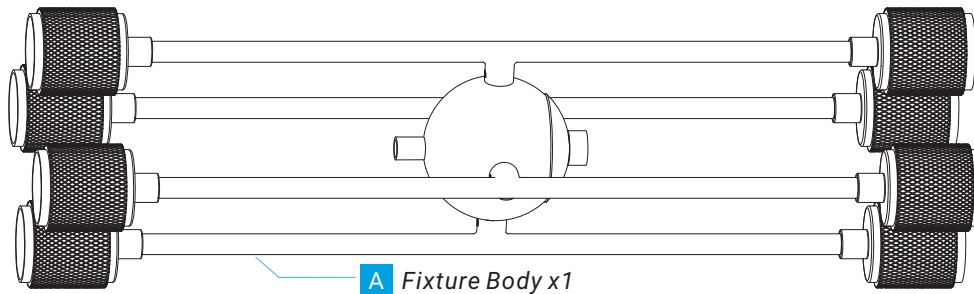

**A** Fixture Body x1



**B** Allen Wrench x1

## MOUNTING HARDWARE

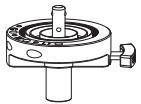

**AA** SkyPlug x1



**BB** SkyOutlet x1  
with 2 rubber washers  
and 2 mounting screws



**CC** Cover Plate x1



**DD** Cap x1  
Use when cleaning &  
painting or when fixture  
is not in use



**EE** 4mm Washer x2  
7mm Washer x2



**FF** Jumper Lead x2  
Optional



**GG** Canopy x1

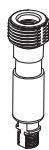

**HH** Swivel x1



**II** Finial Nut x1

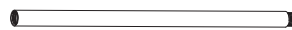

**JJ** 12" Rod x3

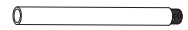

**KK** 6" Rod x1

# Install SkyOutlet

## IMPORTANT:

Disconnect power by turning off the circuit breaker or by removing the fuse at the box. All electrical steps should be performed by a qualified person or electrician.

Scan QR code below for reviewing SkyOutlet installation video.



## 1 Wire SkyOutlet to ceiling junction box.

### A. Strip wire to 9/16"/14mm.

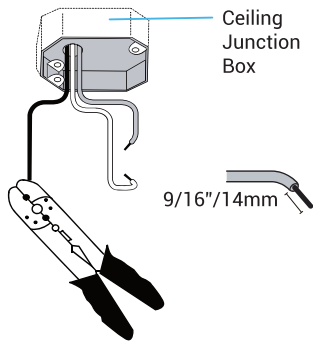

### B. Loosen terminal screws to insert branch circuit wires into the corresponding terminals. Tighten to secure wires. Check to make sure wires are securely inserted into terminals. Set screw torque value at 6.3 lb/in.

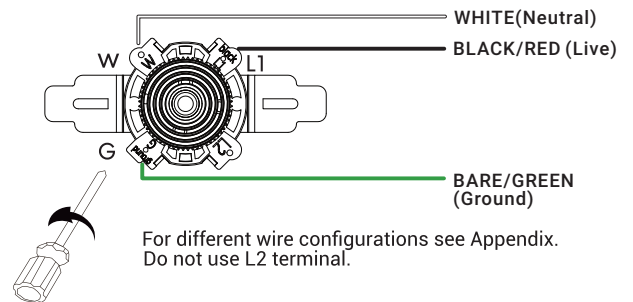

## 2 Secure SkyOutlet to outlet box using 2 screws and washers (included).

For different wire configurations see Appendix.

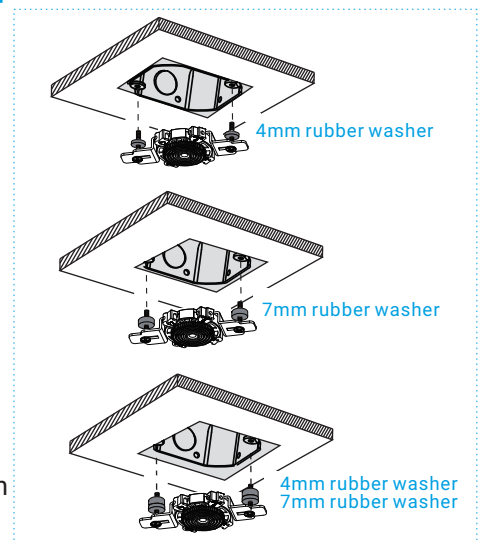
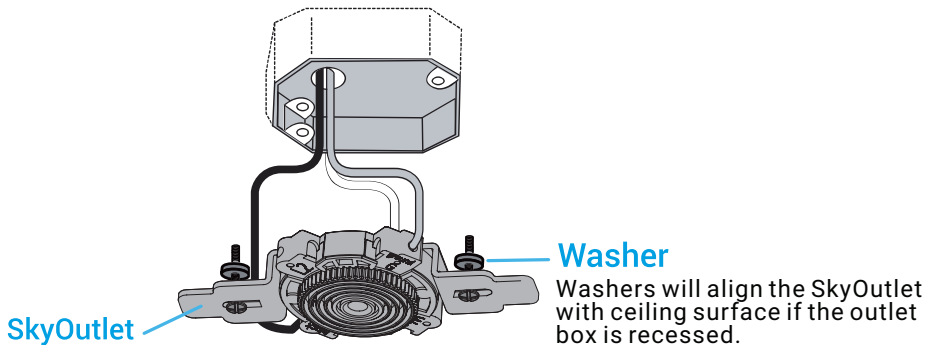

**IMPORTANT:** If your box is flush with ceiling or recessed less than 1.5 mm (0.06"), use 4 mm washer. If recessed between 1.5 mm (0.06") and 3 mm (0.12") use larger 7 mm rubber washer. If recessed more, use combination of both washers.

## 3 Secure cover plate as shown.

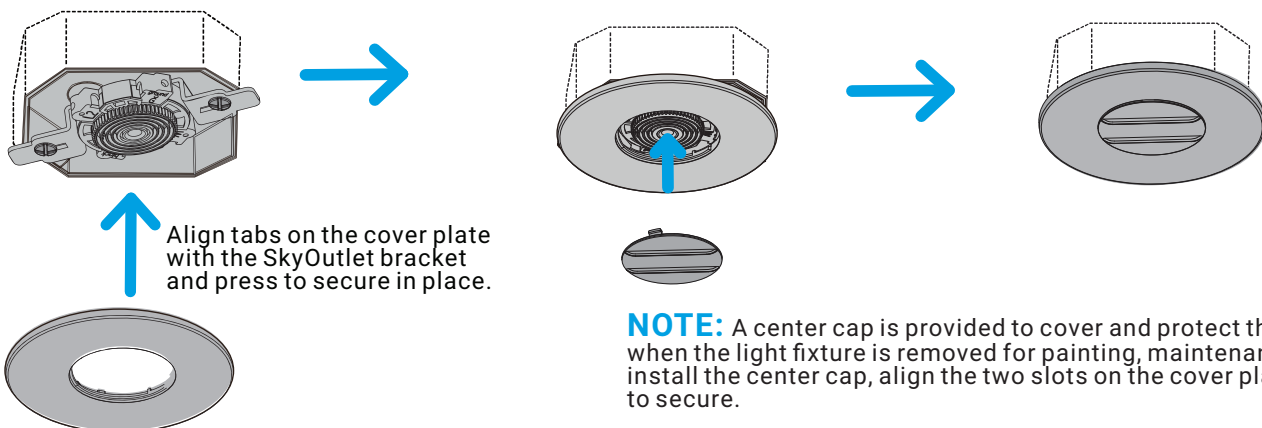

**NOTE:** A center cap is provided to cover and protect the SkyOutlet when the light fixture is removed for painting, maintenance, etc. To install the center cap, align the two slots on the cover plate and turn to secure.

# Assemble Fixture (All steps can be assembled on the floor.)

Scan QR code below for reviewing rod fixture installation video.



## 1 Open the arms.

Open the arms as shown and lock with Allen wrench.

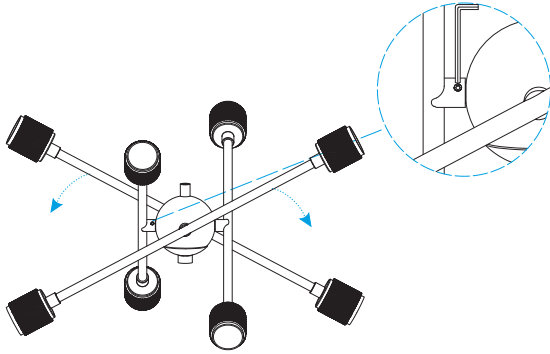

## 2 Install fixture rod.

Determine preferred hanging height of fixture and install rods as needed.

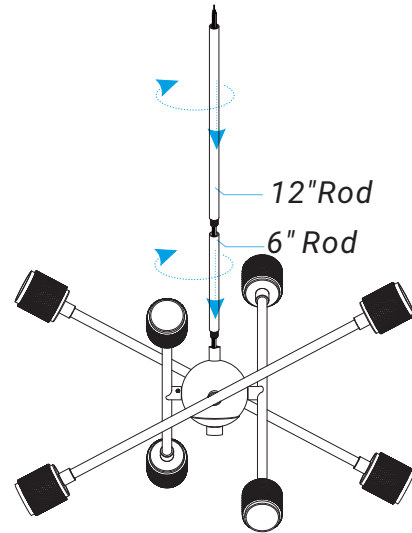

## 3 Install swivel.

Place Finial Nut & Canopy down the rod in the order as shown. Feed fixture wire through Swivel. Install Swivel.

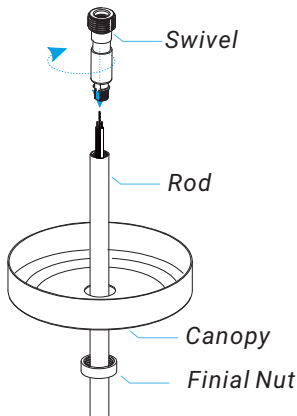

## 4 Install SkyPlug.

Route wires through the U shape opening. Secure and tighten swivel to the SkyPlug as shown.

**CAUTION:**  
To avoid twisting the wires, only turn the upper portion of the swivel, not the SkyPlug.

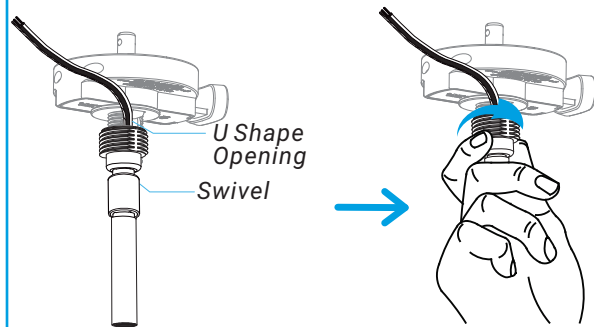

## 5 Wire SkyPlug.

Measure the leads to cut excess wire and strip the leads. Recommended leads length 3", strip length 3/16".

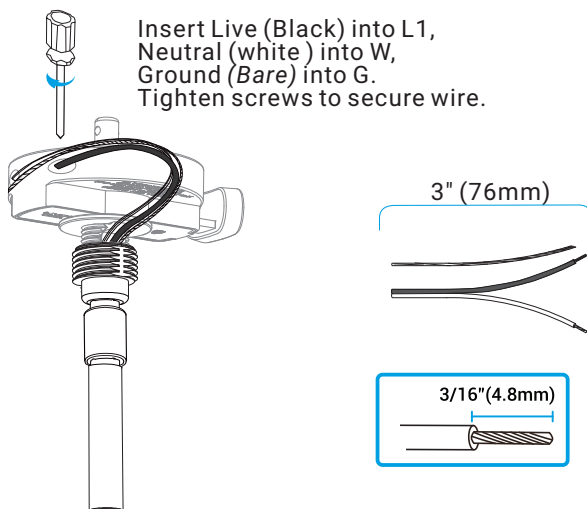

## 6 Install bulbs (not included).

Recommended Bulb Type: E26-G45, Max. 60W

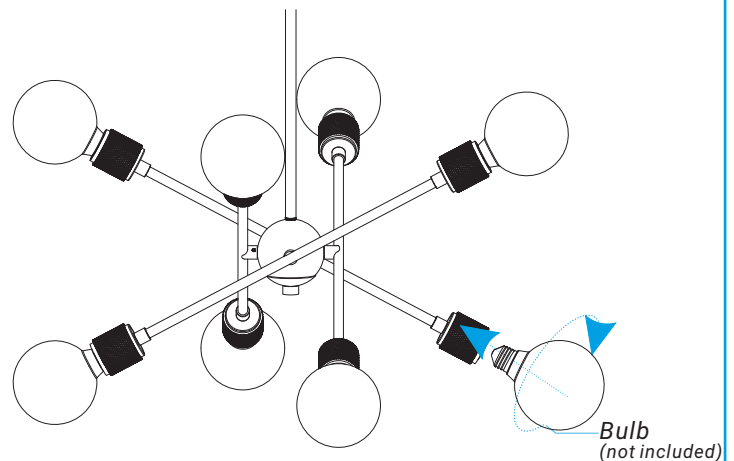

# Connect SkyPlug to SkyOutlet

**1** While supporting fixture, plug into the SkyOutlet.

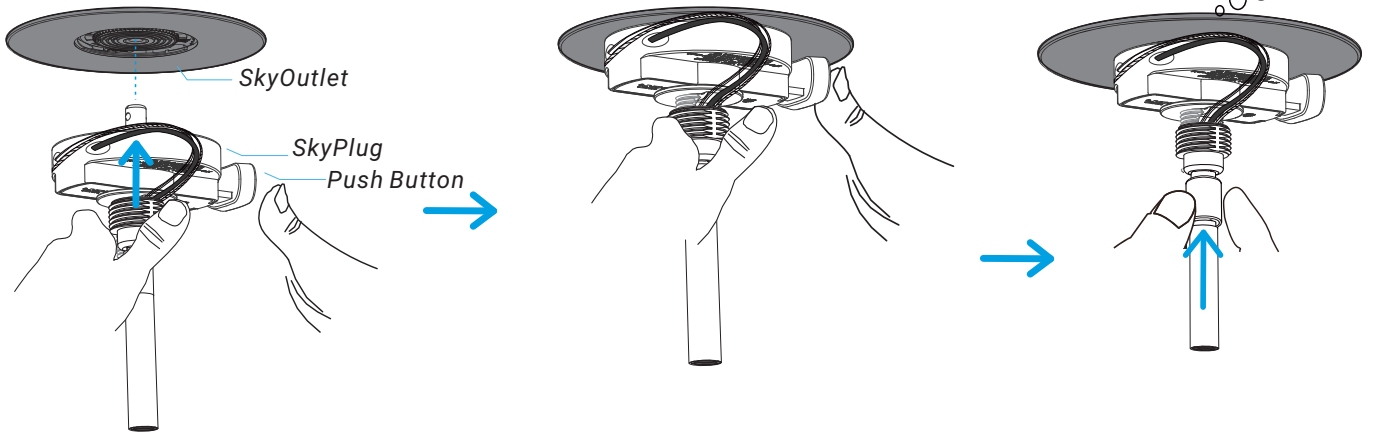

Align with the center hole and press the push button to insert into the SkyOutlet.

Keep button pressed in while inserting SkyPlug into the SkyOutlet.

Once inserted, let go of the push button and push up until you hear the "click" sound.

**2** Once plugged in, slide the Canopy up to the ceiling surface and secure in place with the finial nut.



Your installation is now complete! Restore electricity and save this manual for future reference.

## Removing SkyPlug Fixtures

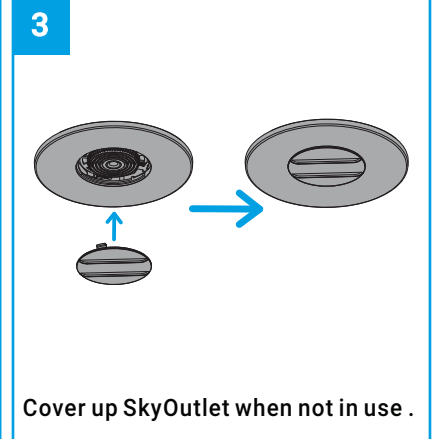
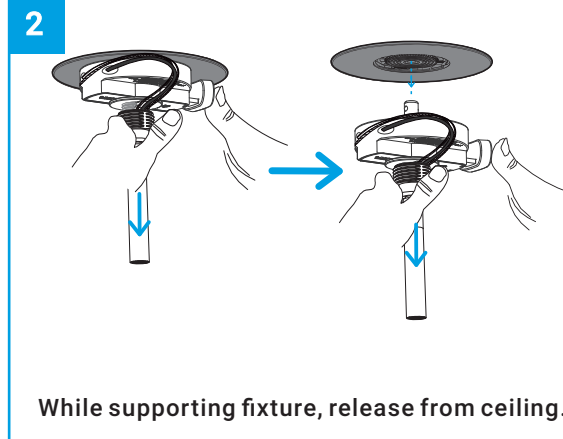
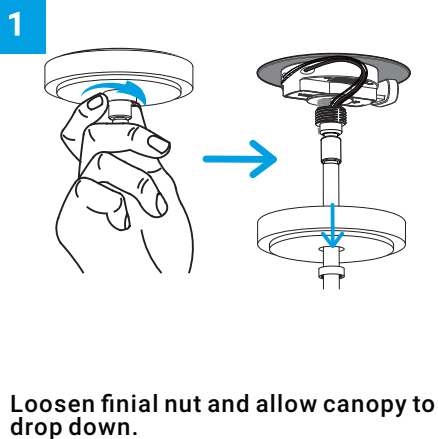

# APPENDIX

## Additional Wiring Diagram

**IMPORTANT:** If you have multiple wires inside your outlet box, you will need to determine which lead is the live or switched lead and insert this lead into L1. If you are not sure how your house is wired, contact 1-866-885-4649 for questions or contact an electrician. When multiple wires are connected together use a solid wire 12 or 14 AWG JUMPER LEAD (included) to insert into the receptacle terminal. **Do not use L2.**

### WIRING DIAGRAM#1:

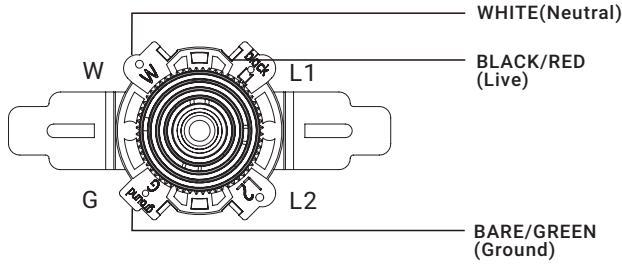

### WIRING DIAGRAM#4:

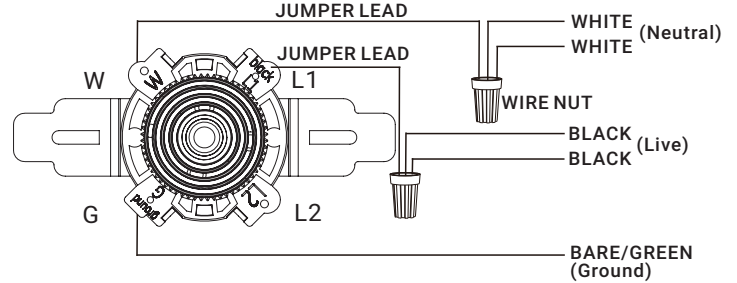

### WIRING DIAGRAM#2:

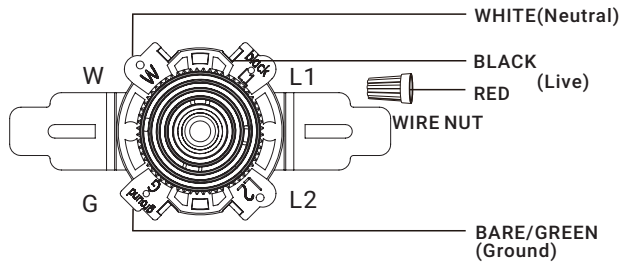

### WIRING DIAGRAM#5:

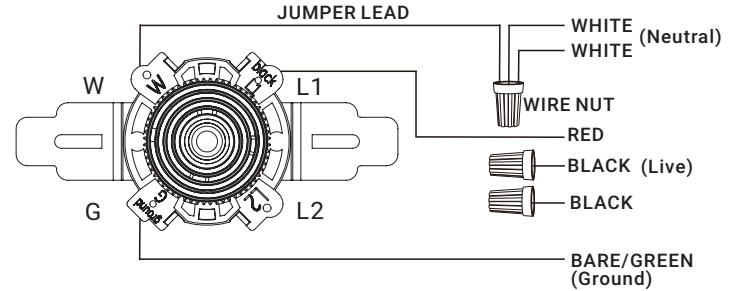

### WIRING DIAGRAM#3:

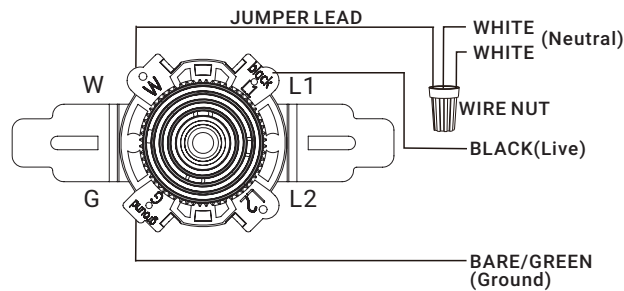

**NOTE:** If you have multiple wires connected together, add **the included JUMPER LEAD** and insert jumper lead into terminal. Only one single wire can be inserted into terminal (See diagram 3-5).

## LIMITED PRODUCT WARRANTY

For warranty info, visit [www.LumLight.com/warranty](http://www.LumLight.com/warranty)