

MODLAND® User's manual

Smart Kitchen Sink



Thank you for your purchase!
If you have any questions after receiving the item—including needing installation guidance (we're happy to provide an installation video upon request)—please do not initiate a return on the store. Contact us first, and we'll assist you promptly.

www.mod-land.com

TEL: +1 657-505-4712

E-mail: info@mod-land.com

Installation & Usage Guidelines

Before Installation

All information is based on the latest product details. The Company reserves the right to modify product features, packaging or types without prior notice. Provide this document to the end user for review before use.

Installation Instructions

1. **Have a professional plumber/installer with relevant experience handle installation.** Consult professionals if unsure to avoid leaks/damage.
2. Do not install alone; seek assistance.
3. Exercise caution to prevent damage to fixtures or personal injury.
4. Ensure proper and secure installation before use.

Important Notes

1. Rinse water supply pipes thoroughly to remove impurities.
2. Mount faucet on new wash basins before installation.
3. Shower pressure: 0.1–0.5MPA. Install a pressure reducing valve if exceeding 0.5MPA.
4. Shower max temp: 60°C. Keep the shower arm tube away from heaters to avoid damage/injury.

Instructions for Use

1. Hand wheel: Turn left for cold→mixed→hot water; turn right to close.
2. Left button controls water outlet mode.
3. **Close the hand wheel (2.5MPA pressure resistance) after each use.** The Company is not liable for losses from non-compliance.

Product Dimensions

30x19x10

(Unit: inch)

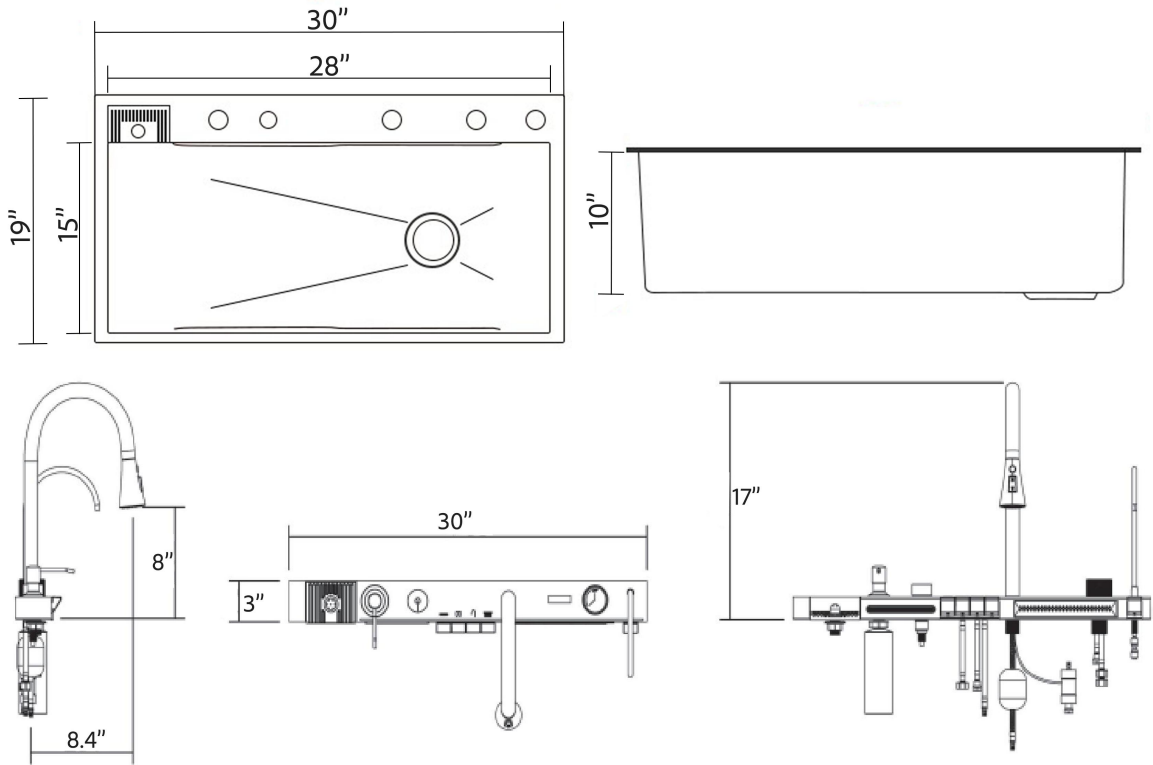





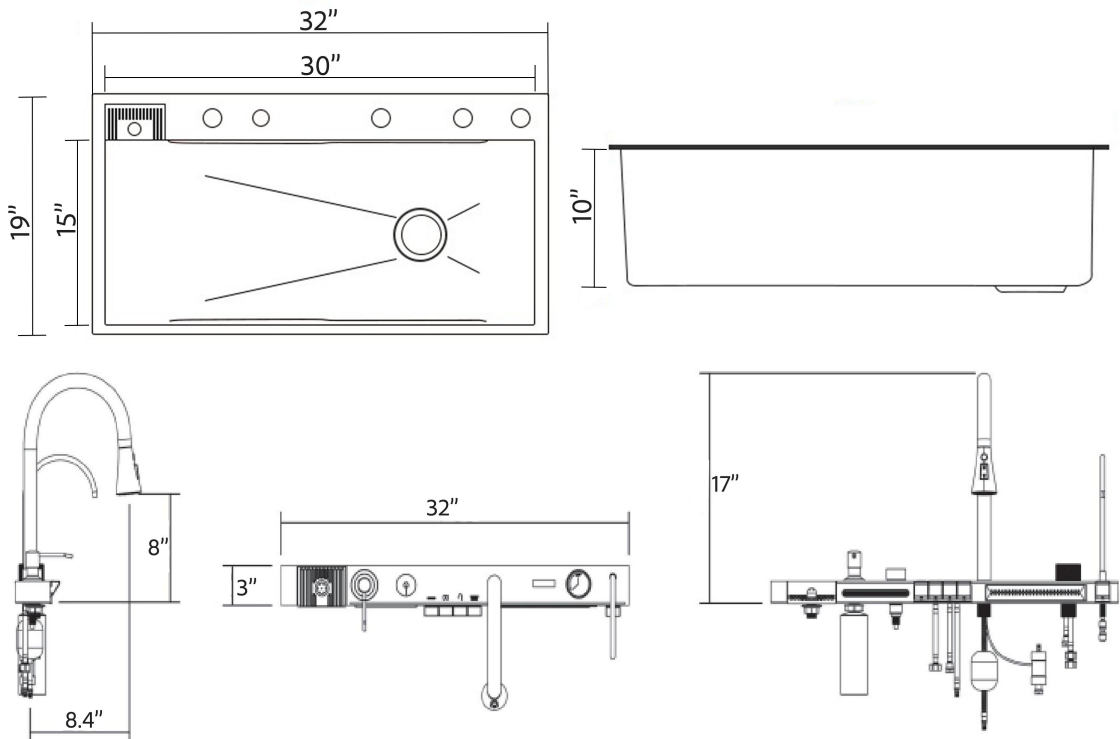

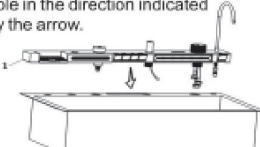
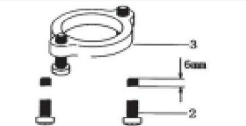
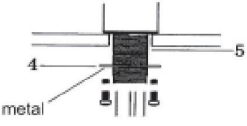
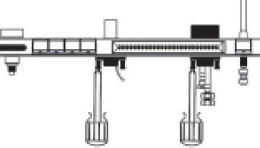
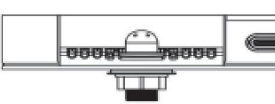
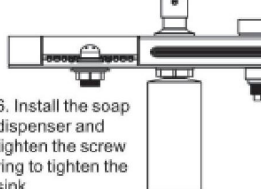
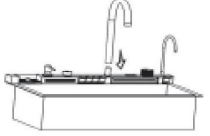

32x19x10

(Unit: inch)

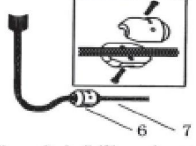
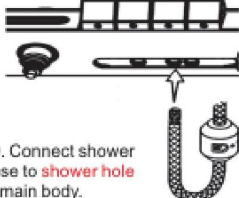
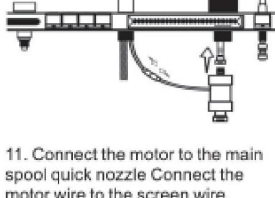
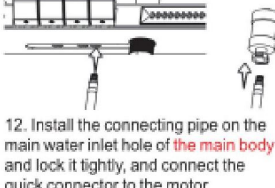
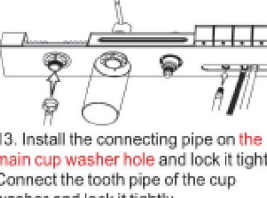
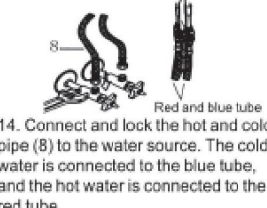
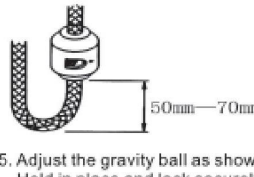
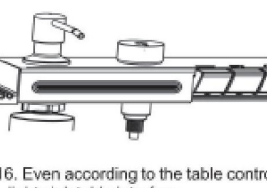
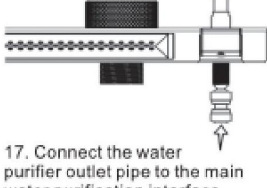

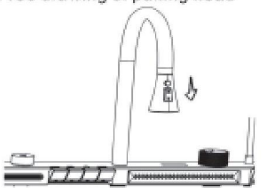
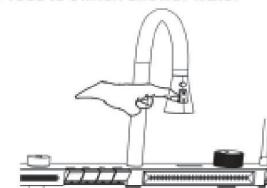



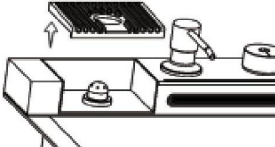







Installation Procedure

Pull the kitchen pot faucet

<p>1. Insert the main body of the faucet (1) into the water slot hole in the direction indicated by the arrow.</p> 	<p>2. Screw the screw into the mounting ring (2) and (3) until the screw is 6mm above the mounting ring.</p> 	<p>3. Install the gasket (4) on the dental tube (5) and screw the mounting ring to the dental tube.</p> 
<p>4. Adjust and tighten the screws for the mounting ring.</p> 	<p>5. Install the cup washer and tighten the screw ring to tighten the sink.</p> 	<p>6. Install the soap dispenser and tighten the screw ring to tighten the sink.</p> 
<p>7. Insert the elbow tightly into the main joint of the faucet and check whether the elbow rotates smoothly.</p> 	<p>8. The drawing pipe is connected to the shower through the bend to check whether the drawing is smooth.</p> 	<p>9. Install gravity ball (6) on shower hose (7) without locking gravity ball first.</p> 
<p>10. Connect shower hose to shower hole of main body.</p> 	<p>11. Connect the motor to the main spool quick nozzle. Connect the motor wire to the screen wire.</p> 	<p>12. Install the connecting pipe on the main water inlet hole of the main body and lock it tightly, and connect the quick connector to the motor.</p> 
<p>13. Install the connecting pipe on the main cup washer hole and lock it tightly. Connect the tooth pipe of the cup washer and lock it tightly.</p> 	<p>14. Connect and lock the hot and cold pipe (8) to the water source. The cold water is connected to the blue tube, and the hot water is connected to the red tube.</p> 	<p>15. Adjust the gravity ball as shown. Hold in place and lock securely.</p> 
<p>16. Even according to the table control light sink table interface.</p> 	<p>17. Connect the water purifier outlet pipe to the main water purification interface.</p> 	<p>18. Turn on hot and cold water and tap switch, let water flow out for about two minutes.</p> 
<p>Free drawing of pulling head</p> 	<p>Press to switch shower water</p> 	<p>Press to switch shower water</p> 
<p>Faucet maintenance: 1. Turn on the faucet and rub the nozzle to clean up impurities.</p> 	<p>2. When impurities reduce the flow, remove the sprinkler head bubbler, clean the bubbler, and reinstall it.</p> 	<p>Cup washer Silicone pad removable for cleaning</p> 

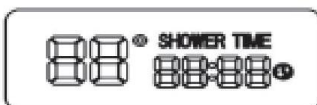
Use Guideline

 <p>Hand wheel switch, turn to the left for constant temperature cold water - mixed water - hot water: turn to the right to close the water main switch. (Always turn it off after each use)</p>	  <p>Rain water key Cannot be used as main switch</p>	  <p>Pull head water button Cannot be used as main switch</p>
  <p>Cup washer water button Cannot be used as main switch</p>	  <p>Waterfall water key Cannot be used as main switch</p>	  <p>Clean water outlet button Cannot be used as main switch</p>
 <p>The digital screen displays the water temperatureEffluent time.</p>	 <p>Console switch knob</p>	 <p>Soap dispenser press key</p>

Installation Completion Check

Ensure all joints are tightly sealed and the hand wheel is in the closed position. Turn on the main water supply and drainage systems, then inspect for leaks—repair any leaking connections promptly.

Cleaning Instructions

For coated surfaces: Clean with neutral soapy water and dry thoroughly using a clean, soft cloth.

Do not use: Ammonia, detergent powder, toilet cleaner, or other harsh chemicals (these may damage the coating).

Avoid: Abrasive cleaning tools or cleaners on faucets and accessories.

MODLAND®



Thank you for your purchase!
If you have any questions after receiving the item—including needing installation guidance (we're happy to provide an installation video upon request)—please do not initiate a return on the store. Contact us first, and we'll assist you promptly.

www.mod-land.com

TEL: +1 657-505-4712

E-mail: info@mod-land.com