

# Installation and Operation Manual

## Integrated Smart Toilet EUT3868

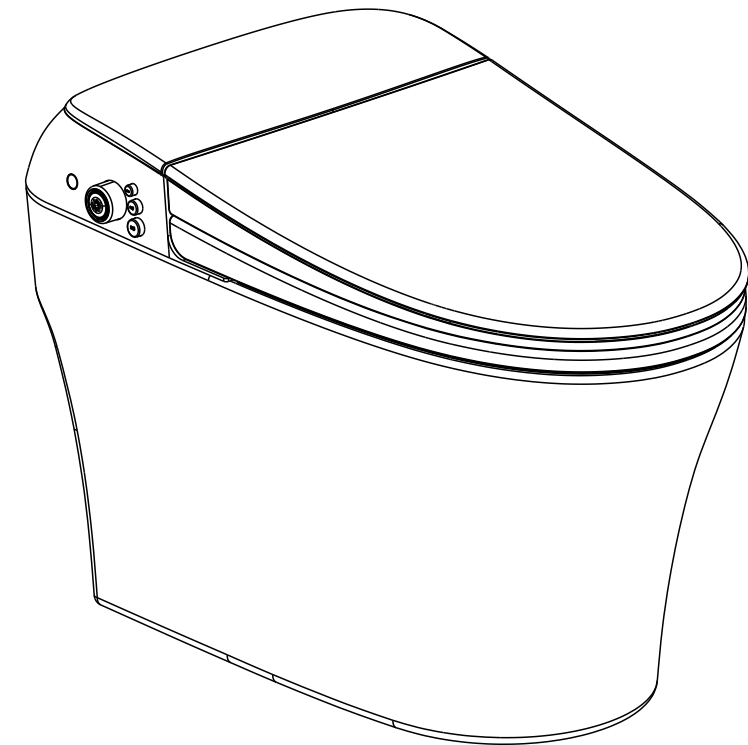

Before using

Operation instructions

Cleaning and maintenance

Fault diagnosis and maintenance

Installation instruction

- Please read this instruction carefully for the proper use of this product. This manual is accompanied by a guarantee, please keep it properly.

# Table of contents

## Before using

- Safety instructions ..... 3
- Precautions for use ..... 7
- Correct operation instruction ..... 8
- Function introduction ..... 9
- Component name of each part ..... 10
- Preparations and precautions ..... 12

## Operation instructions

- Operation instructions ..... 14
- Temperature adjustment method ..... 15
- Adjustment and usage of each function ..... 16
- Flushing method ..... 18

## Cleaning method

- Cleaning method ..... 20
- Daily cleaning method ..... 20
- Other cleaning methods ..... 22

## Fault diagnosis and maintenance

- Fault diagnosis and maintenance ..... 23
- Service/maintenance instruction ..... 27
- Technical data ..... 28
- Guarantee ..... 29

## Installation instruction

- Installation instruction ..... 30
  - The contents of this manual include but are not limited to product materials, processes, functional characteristics, etc., which may be different from physical products due to production process improvements or product updates. Please refer to the latest version of the manual.
  - We reserve all the rights for the final explanation.





# Safety instructions

This product is of Class I. For your safety, please observe the following precautions that is closely related to the user's body and property safety. Please read it carefully and strictly observe it.

**! Instructions for buyers** The full-function remote controller is configured on this machine. Some functions of the full-function remote controller may not be available on this machine. It depends on the model you bought.

※ To avoid the danger caused by arbitrarily resetting the fuse, this product has the fuse closed; Do not use fuses that do not meet the product specifications.

※ The meaning of the diagram is as follows.

 <b>Warning</b>	It means that if the products was handled improperly, the users will dead or be injured seriously.
 <b>Note</b>	It means that if the products was handled improperly, the users will be injured seriously or subject to material damage.
 <b>Disassemble prohibited</b>	It means prohibition. The left diagram indicates "Disassemble prohibited"
 <b>Required</b>	It means that it must be observed. The left diagram indicates "strictly abide by"

 **Disassemble prohibited** Never disassemble or repair or modify by yourself. (May cause fire or electric shock.)

 **Note**

1. This product belongs to electronic products, please do not install the product in a splashed or humid place. Please install exhaust fan and other exhaust equipment to ensure unobstructed air flow when it was installed in the bathroom with bathtub and water closet. (Otherwise, it may cause a fire or electric shock.)
2. The power plug should be kept at least 1 meter away from the bathtub. (Otherwise, it may cause a fire or electric shock)
3. Please use AC110V-120V (50/60Hz) for the power supply (otherwise, fire or electric shock may occur.)
4. Grounding wires are equipped with this product. The power plug must be correctly inserted into the socket and grounded.
5. Please use glass glue to seal the contact parts of the power supply and the plug to prevent the penetration of water or moisture when the product is installed in the bathroom with bathtub and water closet. (Otherwise, it may cause a fire or electric shock.)

※Please ask the installation company for treatment when waterproof devices are not installed.

 **No sprinkling** Do not spray water on the main body or power supply. (May cause fire or electric shock.)

 Prohibition

Malfunctioning products is forbidden to use.  
Under the following circumstances, please unplug the power supply and close the water valve to stop supplying water.

- Fault refers to:
- The main body or water pipe leaks water
  - The product is cracked or damaged
  - There is abnormal noise or peculiar smell
  - The product smokes
  - The product is abnormally hot

 Prohibition

Fault products is forbidden to use, otherwise it may cause fire or electric shock and even indoor water seepage.

Water except tap water and potable water is forbidden to use, Otherwise it may cause skin inflammation.

Do not use loose or shaking power outlets, otherwise it may cause a fire or electric shock  
Power supply or socket beyond specifications is forbidden to use, and only AC110V-120V is used.  
The multi-socket socket is easy to exceed specifications, which may cause heat generation and fire.



Exert excessive force on the power plug or damage is forbidden.  
Arbitrary modification or assembly is prohibited.  
It is forbidden to twist or pull the power cord forcibly.  
It is forbidden to place heavy objects on it.

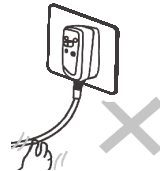

The warm seat may cause low-temperature burns.  
Please turn off the temperature switch of seat when sitting in the seat for a long time.  
Please help close the seat and adjust the temperature when the following people use the warm air drying function of the warm seat:

 Required

Children, the elderly and other users who cannot adjust the appropriate temperature by themselves,  
People who cannot react according to their own consciousness,  
Those who may fall asleep after sitting in a seat, such as people who take sleep pills, drink too much, are overtired, etc.

 Ground

Confirm whether the power supply is grounded?  
Electric leakage and electric shock and other accidents may occur if the power supply is not grounded.  
Please apply to the nearby electrical installation company for grounding work.

 Note

**! IMPORTANT SAFEGUARDS**

When using electrical products, especially when children are present, basic safety precautions should . .

※ always be followed, including the following:

**! READ ALL INSTRUCTIONS BEFORE USING**

 Danger

To reduce the risk of electrocution:

1. Always unplug this product immediately after using.  
Exception: Battery chargers while recharging batteries and permanently connected products such as toilet seat assemblies.
2. Do not use while bathing
3. Do not place or store product where it can fall or be pulled into a tub or sink.
4. Do not place in or drop into water or other liquid.
5. Do not reach for a product that has fallen into water. Unplug immediately.

 Warning

To reduce the risk of burns, electrocution, fire, or injury to persons.

1. A product should never be left unattended when plugged in.  
Exception: Contact lens disinfectors, toilet seat assemblies, and similar products.
2. Close supervision is necessary when this product is used by, on, or near children or invalids.
3. Use this product only for its intended use as described in this manual. Do not use attachments not recommended by the manufacturer.
4. Never operate this product if it has a damaged cord or plug, if it is not working properly, if it has been dropped or damaged, or dropped into water. Return the product to a service center for examination and repair.
5. Keep the cord away from heated surfaces.
6. Never block the air openings of the product or place it on a soft surface, such as a bed or couch, where the air openings may be blocked. Keep the air openings free of lint, hair, and the like.
7. Never use while sleeping or drowsy.  
Exception: Alternating pressure point pad control units and the like.
8. Never drop or insert any object into any opening or hose.
9. Do not use outdoors or operate where aerosol (spray) products are being used or where oxygen is being administered.  
Exception: Oxygen therapy equipment.
10. Connect this product to a properly grounded outlet only. See Grounding Instructions.  
Exception: A cord-connected product that is not provided with a means for grounding or a product intended for permanent connection.
11. Unplug this product before filling. Fill (reservoir) with water only unless otherwise specified by manufacturer. Do not overfill (or specify filling instructions).  
Exception: The instructions for a product with a separable water reservoir need only include "fill reservoir with water only unless otherwise specified by manufacturer."

## ! Note

### ! Note

Persons with physical, perceptual or intellectual disabilities or lack of experience and/or knowledge cannot use this product. The above people can use this product under the condition of receiving supervision or guidance on safe use from their safety principal. For children, the elderly, people with physical and intellectual disabilities or lack of experience and common sense, they must be accompanied by a guardian before use. Do not let children play with appliances, so as not to cause personal or appliance injury.

### ! Required

Do not place flammable material such as fireworks nearby. Otherwise, it may lead to fire. It is forbidden to throw lighted cigarettes and other burning substances into the water closet in case of a fire!

### Prohibit the touch with wet hands

It is forbidden to plug or unplug the power supply with wet hands. Otherwise, it may cause a fire or electric shock.

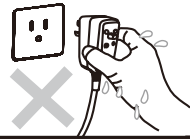

### Prohibition

It is forbidden to tread on the seat, the seat coverlid and main body, and heavy objects is forbidden placed on them. -Otherwise, the product may be damaged. -Otherwise, the product may be damaged and indoor water seepage will occur. It is forbidden to put your fingers or sundries at the warm air outlet.

It is forbidden to touch the warm air outlet with hands or cover it with clothes. -Otherwise, it may cause burns or fire.

Do not bend or flatten the connecting water pipe. -Otherwise, it may lead to water leakage. -Otherwise, the water pressure will be reduced or no water will come out.

Use kitchen detergent to clean. Accurately tighten the connecting water pipe. -Otherwise, it may cause indoor water seepage.

It is forbidden to split the water pipe when the inlet valve is opened. -Otherwise, the water will be splashed.

It is forbidden to throw any sundries except excrement and toilet paper in the water closet. -Otherwise, it may cause the water closet to be blocked or the sewage will leak out to room. It is strictly forbidden to discard combs, toothbrushes and other items in the toilet.

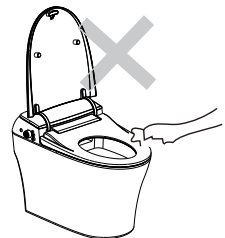

### ! Required

Tighten the filter screen when installing it. - If it is tightened loosely, leakage may occur. Close the inlet valve to stop supplying water when the product leaks water.

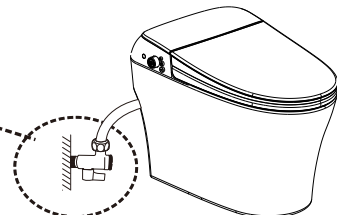
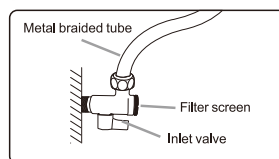

The indoor temperature of toilet should be kept at not lower than 41°F. If the water freezes, the drain pipe or main body will be damaged, resulting in water leakage or fault.

## Precautions for use

Please observe the following:

Please wipe the main body, seat and the seat coverlid with soft cloth.



Please do not install in a place directly exposed to light. -It may cause discoloration, damage and remote control failure of the product.

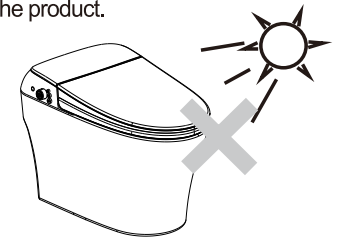

Avoid splashing urine on the main body or sprinkler. -It may cause fault.



It is forbidden to block the contact seat sensing part and remote control sensing part. -It may cause contact seat sensing failure and remote control failure.

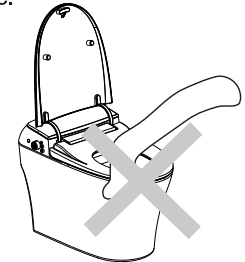

Please disconnect the power supply when not in use for a long time.

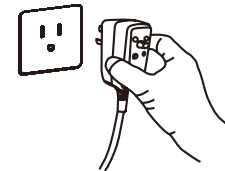

Please turn off the main power supply during thunderstorms. -Failure to shut down may lead to lightning strike, life injury or equipment fault.



Radios and other products are used at a certain distance from this product. -It may interfere with use of the radio and make noise.

Please do not rely your upper body on the seat coverlid when using it. -It may cause defects or damage to the seat coverlid.

### WEEE Guidelines

Parts of products or commodities are treated as wastes, please separate and dispose of them separately. In order to prevent garbage from harming the environment and human body, it is recommended to separate and classify resources for recycling and reuse. Consumers should contact the point of sale or local government agency where the product was purchased to confirm how to recycle it in the environment. Product users should contact the supplier to confirm purchase conditions. This product should be treated separately from other industrial waste.



# Correct operation instruction

# Function introduction

● **Use the power saving function**  
 When it is in the power-saving state, the seat temperature is maintained at about 82°F. When a person is seated during this state, the state will be automatically released and the normal temperature control state is performed.

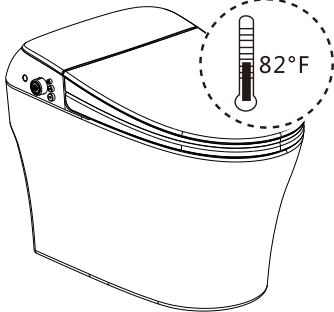

● **Automatic standby**  
 Under no operation, no seat temperature, no seat state, the machine automatically enters standby mode after 3 min: The display and knob lights goes out.

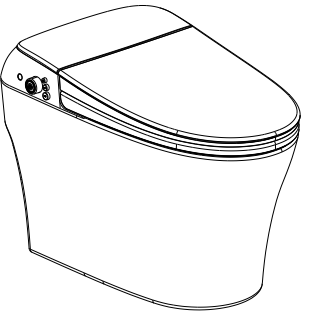

● **Please close the cover of the seat**  
 Close the cover to prevent hot air from the surface of the seat. To save electricity.

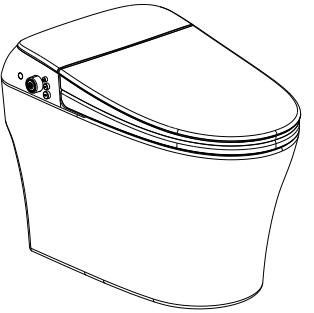

**Operation instructions of foot sensation function**  
 Foot sensation description: The foot sensor senses that there is an object obstructing the sensing area in case of unseat without operation, and the buzzer beeps once, perform a flushing action.

**! Required**  
 Please use tap water for water supply, and do not use other water sources that do not meet hygiene standards.  
 -It can cause inflammation of the cleaning area or equipment fault.

Differentiation	Function	Detailed functions
Basic functions	Hip cleaning/Rear wash	Function of cleaning anus
	Cleaning for lady	Special for lady
	Strong relaxing bowelenema	Cleaning function specially set for constipation patients
	Warm air drying	Dry your hips with warm air
	Adjust water pressure	Adjust the water output and pressure function
	Cleaning position adjustment	Function of adjusting the cleaning position
	Mobile cleaning	Multi-directional cleaning function of moving nozzle back and forth
Convenient function	Adjustable water temperature	Adjust water temperature
	Adjustable seat temperature	Adjust the temperature of the seat
	Adjustable air temperature	Adjust the warm air temperature
	Remote control function	All functions can be easily operated with a remote control
	State manifest	Mark the working state of the smart toilet
	Foot sensor flushing	Use the foot to block the foot sensor to perform flushing and other actions(optional)
Quick function	Automatic flushing	Automatic flushing after people leave the seat
	Remote flushing	Remote flushing with remote control
	Power saving	Power saving function during non-use
Comfortable function	Bubble wash	Bubbles are added to the cleaning water to make it softer and more comfortable
	Warm seat	Temperature-adjustable seat to make people feel warmer
	Slowly descending seat coverlid	Adopt damping device to make the flip of the seat coverlid and seat smoothly with low noise
	Soft light illumination	The LED low-light illuminating urinal makes it feel more warm when it is used
	Deodorization	Keep the air in the toilet fresh
Security function	Anti-overheating	Install a temperature safety device to prevent overheating of water and wind from hurting people
	Prevention against electric leakage	Set up leakage protection device to prevent accidents
Auxiliary function	Emergency button	Buttons to use when the remote control fails
	Manually flush	Use manual flush in case of power failure
	Self-inspection	Self-sensing and reminding when the product is abnormal
Cleaning function	Nozzle cleaning	Self-sensing and reminding when the product is abnormal
	Cleaning nozzle button	Buttons to clean nozzles
	Anti-fouling treatment	Anti-fouling treatment is carried out inside the toilet

Before using

# Structure name of each part

# Remote control screen and knob

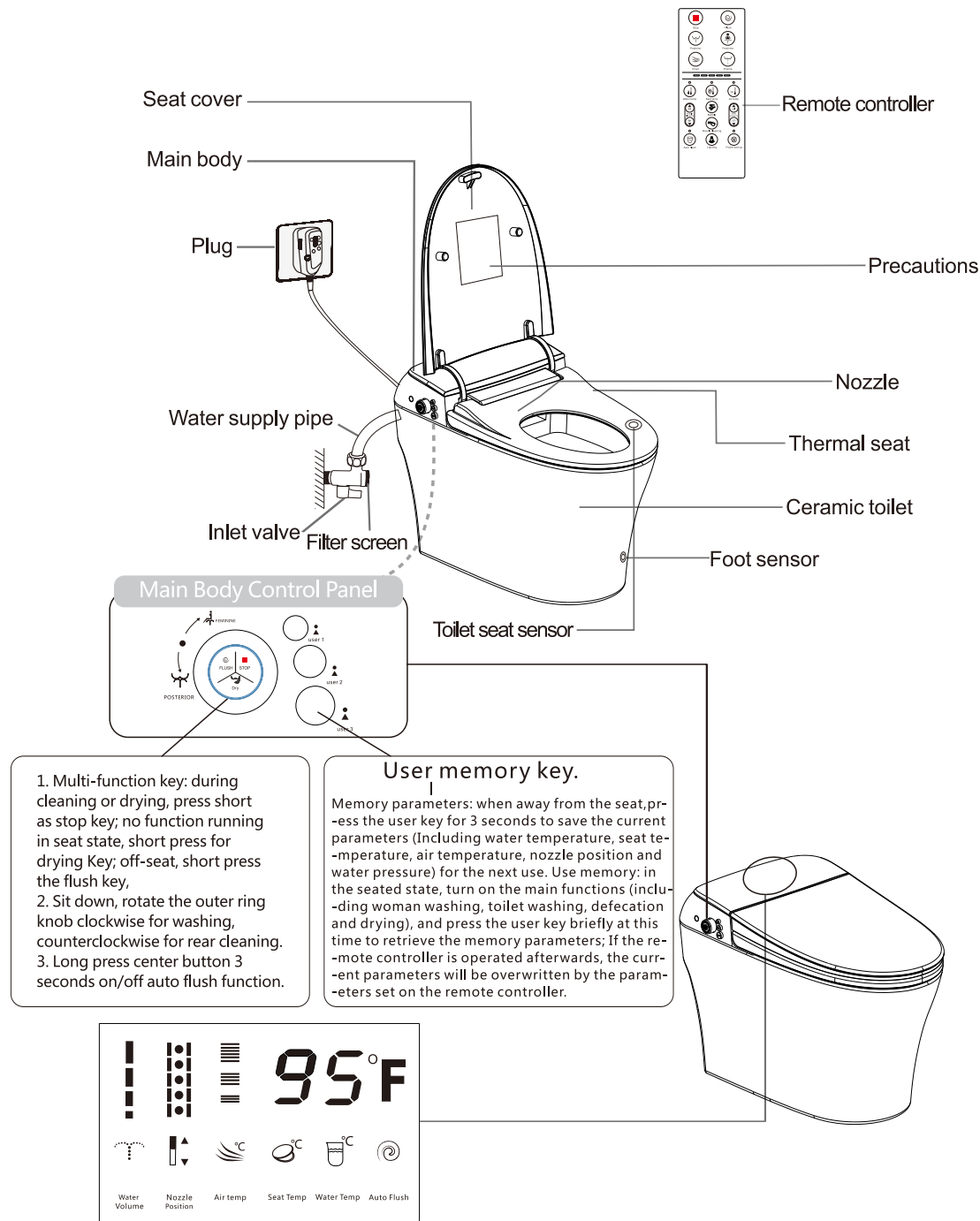

## Automatic flip models. Manual flip models.

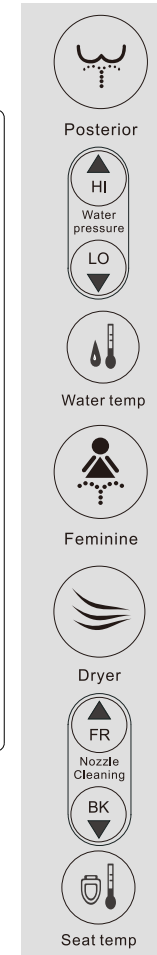
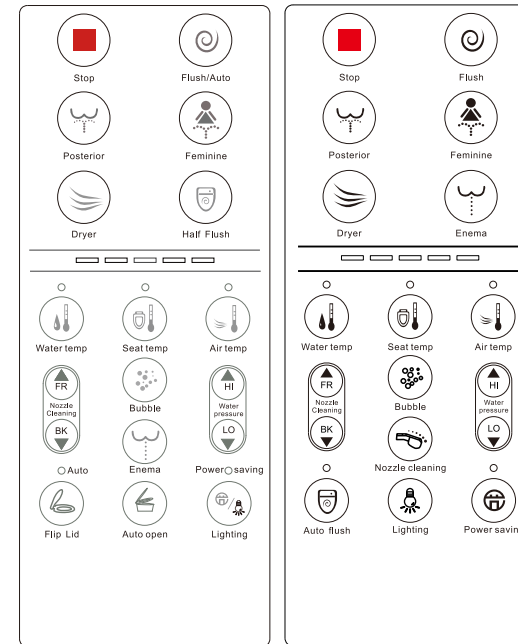

Use when cleaning buttocks  
- Press this button again during cleaning, the nozzle will switch between moving and fixed mode.

Adjustment of water pressure, which is divided into 1 ~ 5 levels.

Adjustment of water temperature, there are 4 levels to choose from.  
-(Room temperature when the indicator lamp is off)

Used by women when cleaning  
-Press this button again during cleaning, the nozzle will switch between moving and fixed mode.

Start the warm air drying function.  
-Dry the water droplets with toilet paper before starting the drying function. It will become dry faster and more comfortable.

There are 5 levels for adjusting the nozzle position during mobile cleaning.

Press this button to adjust the temperature of seat, there are 4 levels for you to choose from.  
-(Room temperature when the indicator lamp is off)

Note: Different models have different remote controls.

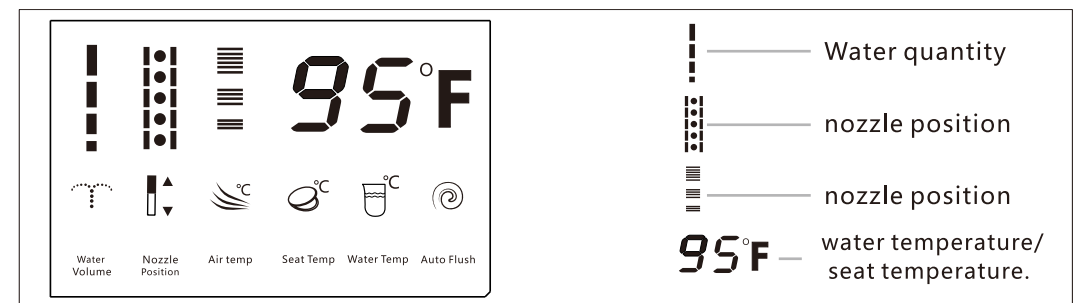

Display failure prompt: (some models have no display).

Alarm status	The display screen	Alarm status	The display screen
Fault of water temperature sensor alarm	E1	Low seat temperature alarm	E6
Fault of the seat temperature sensor alarm	E2	No water alarm	E7
High water temperature alarm	E3	Fan failure	E8
High seat temperature alarm	E4	Multiple faults	EE
Low water temperature alarm	E5		

Before using

## Preparation and confirmation before use

### Preparation

#### 1 Installation of battery

##### Advice

- ① Remove the remote control from the hanger.
  - Hold both ends of the remote control and push up.
- ② Open the battery cover on the back of the remote control.
- ③ Install two AAA batteries in accordance with the battery positive and negative icon
- ④ Close the battery cover.

##### About batteries

- Please observe the following items to prevent the battery from breaking or oozing liquid.
    - Use two batteries of the same type.
    - Take out the battery when not in use for a long time
    - Rechargeable batteries should not be used
- After replacing the battery, the current settings (temperature, power saving, automatic flushing) may be cancelled, please reset it.

#### 2 Ensure that the power plug is plugged appropriately.

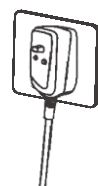

##### Advice

Please unplug the power cord when replacing the battery or repairing the product

## Preparation and confirmation before use

#### 3 Open the inlet valve

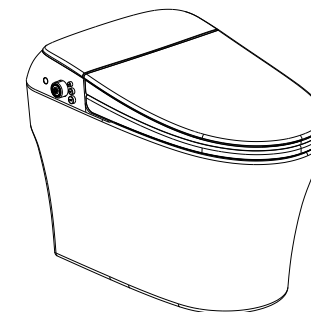
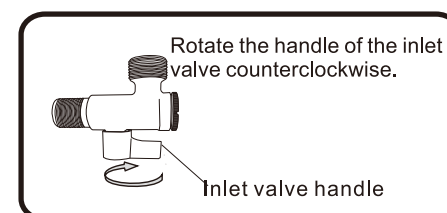

### Precautions

#### 4 Confirm the body display panel

- Is the main body display panel on after power-on self-test?

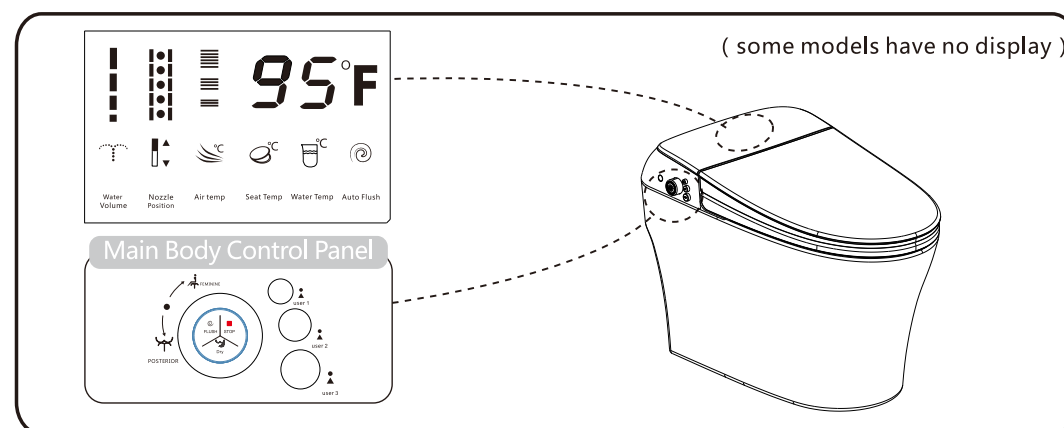

# Operation instructions

# Operation instructions

## 1 Plug

-When the human body does not touch the sensing part of the seat sensor sticker, the sensing may fail. Please refer to the sensing part of the seat sensor sticker on page 9.

## 2 Press the flush button at the top of the remote control

-Used for the first use of the newly installed product.  
-A water seal is created by sitting on the stool.

## 3



Posterior







Feminine



Enema

Correct usage of relaxing bowelenema function.

Press the button of hip cleaningrear wash  or relaxing bowelenema  or female cleaninglady wash 

Select  button

Adjust the nozzle position to the center of the anus.  
-Press the button of strong/weak pressure to adjust the water pressure.  
-After pouring water into the intestines, the abdomen is forced out.  
Please forcefully drain the dirt to avoid water remained in the intestines.

-The selected function can be used for 90 s. Default is mobile cleaning (relaxing bowelenema is fixed)

## 4



### Press the stop button

Stop

Hip cleaning, female cleaning, relaxing bowelRear wash, lady wash, enema and other functions will be stopped.

## 5



### Press the dry button

Dryer

- You can use the selected function for 3 min.

## 6



### Press the stop button

Stop

## 7 Flush



Flush



Half Flush





Flush/Auto

**Advice** Try to lean against the back of the water closet and close to the seat when seated. Proper cleaning location can reduce the possibility of splashing water

## ◆ A quick way ◆

**Quick cleaning 1 Mobile cleaning**  
Move the nozzle back and forth to clean all corners.

1.  Select the function button to be used.
2. Press  button.  
-Mobile cleaning.
3. Press  again  
-Stop mobile cleaning.

## Temperature adjustment method

- Temperature of seat and water can be adjusted by remote controller. Please set the appropriate temperature.

- 1 Take out the remote controller
- 2 Adjust the temperature

Seat temperature, water temperature and wind temperature can be adjusted by pressing the corresponding function buttons continuously to adjust the four states. Please press the corresponding button to the remote controller interface without this function display if you want to adjust to normal temperature. The function interface of the remote control will change with the press of the button. Please set the appropriate temperature.

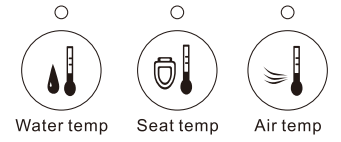

Adjust water temperature

→

Temperature status    Low                      Medium                      High

Adjust the temperature of the seat

→

Temperature status    Low                      Medium                      High

Adjust the warm air temperature

→

Temperature status    Low                      Medium                      High

- When the seat is touched, the seat temperature originally set to gear 2 and 3 will automatically drop to gear 1, and the original setting to "normal temperature" or gear 1 will remain unchanged.

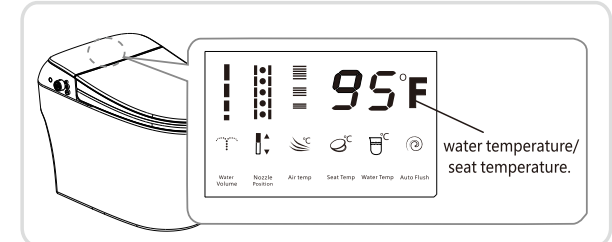









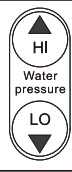

### Cleaning rate test

1. For the central point: First set the spray gun in level 5 and press the hip cleaningrear wash (stop moving), and then aim the spray point at the center of sandpaper.
2. During the test, press the hip cleaningrear wash (moving status), and set the spray gun in level 1, level 2, level 3, level 4 and level 5 respectively to clean each for 1 min.





# Adjustment and usage of each function

## • Automatic flip models.

<p><b>Adjust the water pressure (water potential)</b></p> <p>The water pressure can be adjusted in 5 levels with this button. Please set the appropriate water pressure for the water pressure display light will change with pressing the button.</p>	
<p><b>Adjust nozzle position</b></p> <p>Press this button for hip cleaning/rear wash or female cleaning to adjust the nozzle to the best position.</p>	
<p><b>Clean the nozzle</b></p> <p>When no one is sitting, long press the button, and the nozzle will automatically extend and stop. Clean the nozzle with toothbrushes or other appliances. Sit or press the stop button to stop cleaning.</p>	 <p>Posterior</p>
<p><b>Power saving function</b></p> <p>Long press this button until the power saving indicator lamp on the remote control lights up. The power saving function will ensure that the seat ring temperature is kept in 82°F. To cancel the power saving mode, long press this button until the power saving indicator lamp is off. If the product is used, the power saving mode will be canceled. (In the power saving state, the temperature of the seat may be lower than the set temperature.)</p>	<p>Power saving</p>  <p>Lighting</p>
<p><b>Soft light illumination.</b></p> <p>Press this function key to open the soft light illumination, which creates a warm atmosphere for users.</p>	<p>Power saving</p>  <p>Lighting</p>
<p><b>One button to clean</b></p> <p>In seating mode, press the "Washing" "FemaleLady" button on the side to turn on the--button washing function; The cleaning time is 90 seconds, the flushing function is automatically executed after the cleaning, and the drying function is automatically executed for 3 minutes after 1 second</p>	
<p><b>A flipping cover/flipping seat</b></p> <p>Press the  button to open the seat coverlid.</p> <p>Press the  button for a long time to turn on/off the automatic flip function. (When the  automatic flip function is turned on, the cover is automatically opened when a person approaches the sensing area, and closed after a person leaves for 90 s.)</p> <p>Press the  button to open the seat.</p>	<p>○ Auto</p>  <p>Flip Lid</p>  <p>Auto open</p>

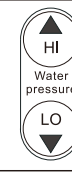
# Adjustment and usage of each function

## • Manual flip models.

<p><b>Adjust the water pressure (water potential)</b></p> <p>The water pressure can be adjusted in 5 levels with this button. Please set the appropriate water pressure for the water pressure display light will change with pressing the button.</p>	
<p><b>Adjust nozzle position</b></p> <p>Press this button for hip cleaning/rear wash or female cleaning to adjust the nozzle to the best position.</p>	
<p><b>Clean the nozzle</b></p> <p>When no one is sitting, press the button, and the nozzle will automatically extend and stop. Clean the nozzle with toothbrushes or other appliances. Sit or press the stop button to stop cleaning.</p>	 <p>Nozzle cleaning</p>
<p><b>Power saving function</b></p> <p>Press this button until the power saving indicator lamp on the remote control lights up. The power saving function will ensure that the seat ring temperature is kept in 82°F. To cancel the power saving mode, press this button until the power saving indicator lamp is off. If the product is used, the power saving mode will be canceled. (In the power saving state, the temperature of the seat may be lower than the set temperature.)</p>	 <p>Power saving</p>
<p><b>Soft light illumination</b></p> <p>Press this function button to open the soft light illumination, which creates a warm atmosphere for users.</p>	 <p>Lighting</p>
<p><b>One button to clean</b></p> <p>In sitting mode, turn the side knob to open the toilet or women's washing, open the one-key cleaning function; Cleaning time 90 seconds, After the cleaning is finished, it automatically performs the flushing function. After 1s, it automatically performs the drying function for 3 min. In sitting mode, turn the side knob to open the toilet or women's washing, open the one-key cleaning function; Cleaning time 90s, After the cleaning is finished, it automatically performs the flushing function. After 1s, it automatically performs the drying function for 3 min.</p>	

# Flushing method

## • Automatic flip models.

Flushing methods include remote control flushing, automatic flushing, and manual flushing.

### Remote control flushing

- Press the remote control button    
Flush/Auto Half Flush

### Set automatic flushing mode

- Press the automatic flushing button on the remote control until the indicator lamp lights up or press the stop button on the side for 3 s, the water closet will flush automatically after drying or users leave the seat.



### Manual flushing method

- Press the remote control button   
Flush

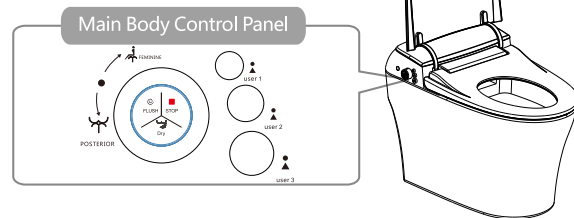

# Flushing method

## • Manual flip models.

Flushing methods include remote control flushing, automatic flushing, and manual flushing.

### Remote control flushing

- Press the remote control button   
Flush

### Set automatic flushing mode

- Press the automatic flushing button on the remote control until the indicator lamp lights up or press the stop button on the side for 3 s, the water closet will flush automatically after drying or users leave the seat.



### Manual flushing method

- When away from the seat, press the knob briefly to flush water.

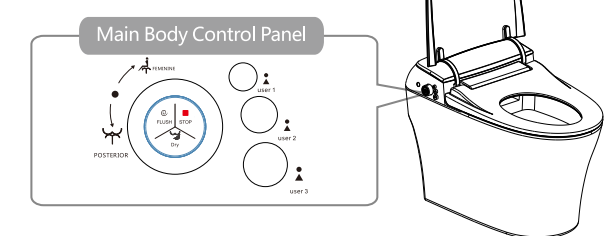

# Cleaning method

## Daily cleaning method

### ◆ Clean the main body, water closet, and the seat coverlid

#### ● Use a wet soft cloth

-Gently wipe with a wet soft cloth.

#### ● When the product gets stained with toilet cleaner

-wipe off the toilet cleaner with a soft cloth, and then wipe the remaining water clean.

#### ● In case of dirty

-wipe it with a soft cloth dipped in diluted kitchen cleaner (neutral).  
-and wipe the remaining water clean at the end.

#### ● Clean the floor of bathroom

-When the floor of bathroom is stained with urination spilling from the bidet seat or sewage falling from the cleaning tools, wipe them off with a wet towel.

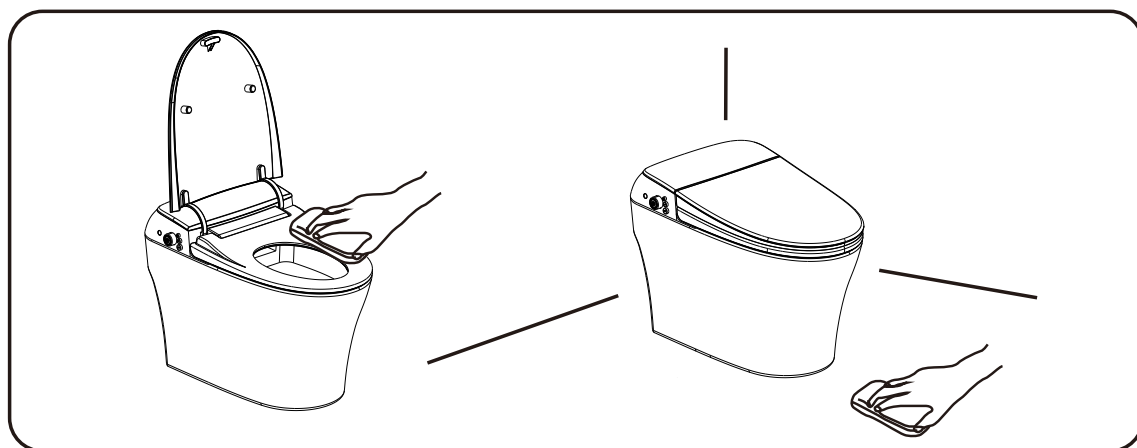

#### Advice

This product is an electronic product. Therefore, please avoid water flowing inside the machine when cleaning.

The seating sensing parts and the inductive head of the remote control should be kept clean. If the sensing parts are dirty, the set functions may operate incorrectly or not operate.

# Cleaning method

## ◆ Clean the nozzle

● Only the nozzle extends out, it does not spray water. So it is easy to clean the nozzle.

### 1 Lead-out nozzle (refer to page 15)

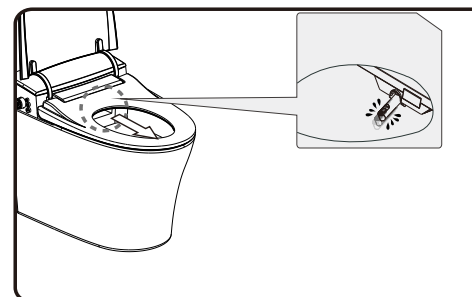

### 2 Cleaning Please clean with a soft brush or toothbrush

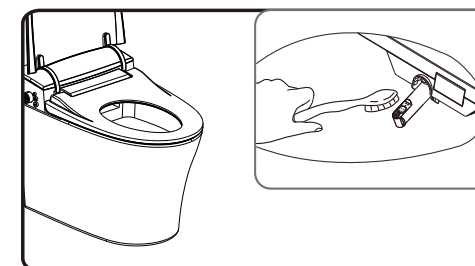

### 3 Cleaning Clean up the dirt on the nozzle.

### 4 Ensure the nozzle homing

Press the "Stop" button again

Nozzle homing

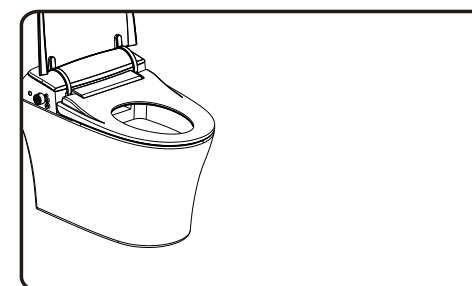
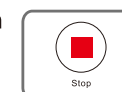

Please do not pull or push the nozzle. Because it may cause damage or fault of the nozzle.

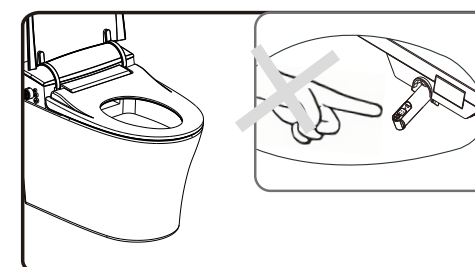

#### Advice

Clean the nozzle  
-Please do not clean with any cleaner but water. Please do not use too much force, which may deform the nozzle.

# Other cleaning methods

## Clean the filter screen

- If the pressure of water column decreases during cleaning, please clean the filter screen.

**1 Please close the water valve to stop water supply.**  
Rotate the handle of the inlet valve clockwise.



**Note**

**Prohibition** When the water valve is not closed, please do not disassemble the filter screen to avoid water spraying out.

**2 Disassemble the filter screen**  
Rotate the filter screen counterclockwise from the nozzle.

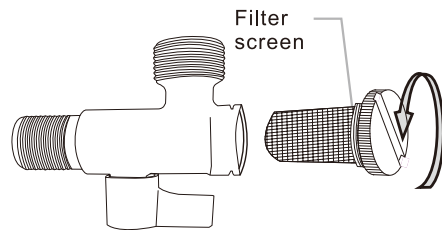

**3 Clean**  
Disassemble the filter screen and clean up the dirt on it.  
-Clean up dust with toothbrushes or other appliances.  
-Clean up dust or impurities inside the water valve with a duster cloth.

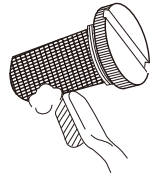

**4 Reinstall the filter screen**  
Rotate the filter screen clockwise to reinstall it.

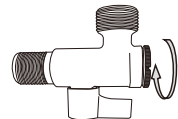

**Note**

**Required** Install the filter screen and tighten it.  
-Loosening will lead to water leakage.

**5 Open the water valve**  
Rotate the handle of the inlet valve counterclockwise to open it.  
-Please check the leakage when supplying water.

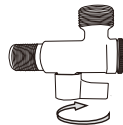

### Advice

Clean the filter screen  
-Please do not clean with any cleaner but water.  
-Do not use too much force when cleaning, which may deform the filter screen.

# Fault diagnosis and maintenance

In case of fault, please read the following notes before taking measures. If the fault cannot be resolved, please contact the purchase outlet, exclusive stores or our customer service center.

※Please unplug the control power cord before maintenance.

**Note**

※When damaged, the power cord should be replaced by the manufacturer, after-sales service center or qualified professionals for fear of safety accidents.

**Required**

※When water leakage occurs, rotate the handle of the inlet valve clockwise first to stop water supply.  
Inlet valve handle

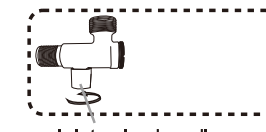

Inlet valve handle

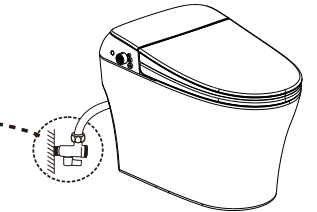



- Please confirm the following items before requesting maintenance

Fault symptom	Judge (cause)	Troubleshooting
<b>Check the power supply</b>		
The function does not work	Is there a power cut? Does the power outlet have electricity? Is the main power on?	Please wait for electricity or turn on the socket power. Please turn on the main power supply.
<b>Hip, female, laxativelady, enema</b>		
No water supply when cleaning	Is there a water cut? Is the water valve closed? Is the sensing part touched?	Waiting for water. Please open the water valve. ⇨ Refer to page 12 Please refer to the sensing part of the seat sensor sticker on page 9.
The pressure of cleaning water decreases.	Is the set pressure of water low? Is the filter screen blocked?	Press the  button on the remote control to increase the water pressure. ⇨ Refer to page 15/16 Clean the filter screen.
The water temperature is relative low.	Is the warm water switch turned off? Or is the set temperature too low?	Press the  button on the remote control to adjust the water temperature. ⇨ Refer to page 14
Stop spraying water after cleaning for 90s.	Factory settings, not faults	Press the   button again. ⇨ Refer to page 13

# Fault diagnosis and maintenance

Fault symptom	Judge (cause)	Troubleshooting
Water supply is cut during cleaning	The human body may not touch the seating sensor.	Please confirm the position of the seat and seating sensor on page 9.
When seating, the nozzle sprinkles water to the inside of the water closet for a few seconds.	After the seating sensor senses, the sensor sprinkles water again to provide warm water. It is not a fault.	
<b>Seating sensor</b>		
The washing or deodorization function turns on when no one is sitting.	Is the seat splashed by water? Or is there a wet towel on it?	Please wipe the water off with a dry towel. Please remove the wet towel
<b>Automatic flushing</b>		
Automatic flushing function cannot be started	Please wipe the water off with a dry towel. Please remove the wet towel.	Please wipe the water off with a dry towel. <small>☞ Refer to page 17/18</small> Please remove the wet towel.
<b>Thermal seat</b>		
The temperature of seat is relative low	Is the seat switch turned off? Or is the set temperature too low?  Is it in a state of power saving?	Press the  button on the remote control to adjust the temperature. <small>☞ Refer to page 14</small> Please wait for 5 min after seating.
<b>Power saving function</b>		
Power saving function does not work	Is the control power cord unplugged? Or is there a power cut?  Dose the battery of the remote control run out?	Dose the battery of the remote control run out? <small>☞ Refer to page 15/16</small>
<b>Remote control</b>		
The remote control is out of control	Dose the battery run out? Is the battery +- direction installed correctly? Is the inductive head of the remote control blocked? Is the inductive head of the remote control dirty with dust or water stain? The human body may not touch the seating sensor.	Replace with new batteries. <small>☞ Refer to page 11</small> Please install the battery correctly. Please remove the occlusion objects. Please clean the dust or water stain. Please confirm the position of the seat and seating sensor on page 9.

# Fault diagnosis and maintenance

Fault symptom	Judge (cause)	Troubleshooting
<b>Remote control flushing</b>		
Remote control flushes out of control.	Is the battery of the remote control exhausted?  Is the sensor head of the remote control dirty by dust or watermark?  Is the sensor head of the remote control blocked?	Replace the battery.  Clean dust or watermark.  Move the obstruction.
<b>Automatic deodorization</b>		
Deodorization function does not work	The human body may not touch the seating sensor.	Please confirm the position of the seat and seating sensor.
The deodorant effect is not good.	Is the deodorant box blocked?	Clean the deodorant box.
<b>Warm air drying</b>		
Warm air temperature is relative low	Is the drying temperature low?	Press the  button on the remote control to adjust the temperature.
Drying stops halfway	Press the  button for about 3 min, the function automatically stops. The change of sitting position may close the seating sensor to stop the drying function.	Please press the  button again.  Please confirm the position of the seat and seating sensor.
Warm air drying does not work	The human body may not touch the seating sensor.	Please confirm the position of the seat and seating sensor.
<b>Others</b>		
The dirt cannot be flushed clean	Is the water valve fully open? Is the filter screen of the water valve blocked? When sharing the water supply with the bathroom, the pressure of water is too low.	Please open the water valve completely. <small>☞ Refer to page 12</small>  Clean the filter screen. <small>☞ Refer to page 21</small>
There is no flushing water	Is the water valve closed? Is there a water cut?	Please open the water valve completely, aiting for water. <small>☞ Refer to page 12</small>
Are the screws at the contacting part loose	Is the screw on contacting part loosening?	Tighten the screws with tools.

# Fault judgment and maintenance

# Service/maintenance instruction

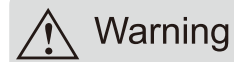

**Warning**

- Indicates an imminently hazardous situation which, if not avoided, will result in death or injury



Observe strictly

※ For all grounded, cord connected products:



## GROUNDING INSTRUCTIONS

Improper use of the grounding plug can result in a risk of electric shock.



**Danger**

This product should be grounded. In the event of an electrical short circuit, grounding reduces the risk of electric shock by providing an escape wire for the electric current. This product is equipped with a cord having a grounding wire with a grounding plug. The plug must be plugged into an outlet that is properly installed and grounded.

If the power cord or plug needs to be repaired or replaced, do not connect the groundwire to any of the flat pins. The conductor with green strip or without yellow stripe on the outer insulation surface is grounding wire.

If you do not fully understand the grounding instructions or if you have questions about whether the product is properly grounded, please consult qualified electrician or maintenance personnel.

This product is for use on a normal 120 V circuit and has a grounding plug that looks like the plug illustrated in sketch A in Figure 1. A temporary adapter, which looks like the adapter illustrated in sketches B and C, may be used to connect this plug to a 2-pole receptacle as shown in sketch B if a properly grounded outlet is not available. The temporary adapter should be plugged into a properly grounded outlet (sketch A) and should be installed by a licensed electrician. The green colored rigid ear, lug, and the like extending from the adapter must be connected to a permanent ground such as a properly grounded outlet box cover. Whenever the adapter is used, it must be held in place by the screw.

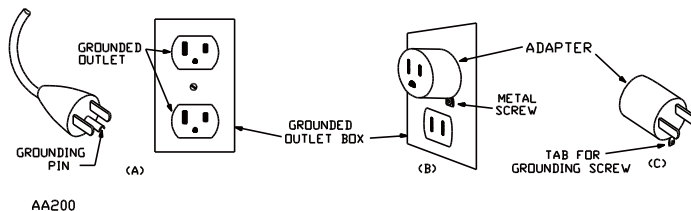

**Danger**

The product is factory-equipped with a specific power cord and plug that allow connection to the appropriate circuit. Make sure the product is connected to the same socket as the plug configuration. This product should not use adapters. Do not modify the supplied plug, if it is not suitable for the socket, please install the appropriate socket by a qualified electrician. If the product must be reconnected using different types of circuits, it should be reconnected by qualified maintenance personnel.

The use of an extension cord is not recommended or advised. If it is necessary to use an extension cord, use only a three-prong extension cord (one to one), and a three-slot built-in GFCI receptacle that will accept the plug on this product. The marked rating of the extension cord should be equal to or greater than the electrical rating of the unit (10amp). Consult a licensed electrician if you are not sure whether the unit is properly grounded.

This product should be connected to a grounded, metallic, permanent wiring system, or an equipment-grounding conductor should be run with the circuit conductors and connected to the equipment grounding terminal or lead on the product.

Please confirm all items in "The Considered Situation of Faults" before requiring maintenance.

### ● Warranty

- The warranty is attached to this specification with the required contents like the purchase outlet and installation date, which should be kept properly when it is confirmed.
- The warranty period is 1 year from the date of installation.

### ● The period of market supply of awaiting parts

- The period of market supply of awaiting parts is 6 years from the production day of products.

### ● When maintenance is required during the warranty period

- Please contact service center to require maintenance if the product is still abnormal after the specification is read again and confirmed.
- The warranty should be provided when maintenance is required.

#### The contents that should be provided when contacting are as follows

- address, name, telephone number
- Product name
- Number
- the date of maintenance at customers' convenience
- Installation date

### ● When the products that exceed the time limit are required for maintenance,

- Please consult with the purchase outlet first.
- The products that have been maintained or put into normal use will be charged for maintenance in accordance with the requirements of customers.

### Periodical inspection is advised. (Not free)

- We suggest the periodical inspection of the products that have been used for more than 3 years in order to use products more safely and speedily for a longer time.

### Details of maintenance cost (when maintenance is required)

Maintenance cost consists of "technical fee", "fitting fee", and "door-to-door service fee".

"Technical fee" refers to the expense of checking faults, repairing and replacing accessories, and all work after finishing repair, like inspection.

"Fitting fee" refers to the expense of the accessories used in maintenance. Fault diagnosis and maintenance

"Door-to-door service fee" refers to the expenses of technicians in the process of commuting to the location of malfunction.

# Technical data

# Guarantee

Model		EUT3868			
Rated voltage		110V-120V			
Rated frequency		50/60Hz			
Rated power		1550W <small>(Water pressure is 0.2±0.02MPa, and water inlet temperature is 59°F. The highest temperature of hip and female cleaning lady wash is chosen and bubble is closed with water potential in level 5 and the seat temperature in the highest level. Before testing, water temperature should be closed, and cold water should operate 2-3 periods to drain the residual hot water in water tank. After finishing this step, water temperature and seat temperature should be changed into the highest level and the cleaning should be opened at the same time. Timekeeping should start when the spray gun sprays water, maximum recorded power.)</small>			
Rated power	Nominal water consumption	Grade 2 of 5.0 L Water Efficiency			
	Flushing method	Syphon			
Cleaning devices	Hip cleaning/Rear wash	350-550 ml/min (water pressure: 0.2 MPa)			
	Cleaning for lady	350-550 ml/min (water pressure: 0.2 MPa)			
	Relaxing the bowels Enema	300-550 ml/min (water pressure: 0.2 MPa)			
	Water temperature	The water temperature is 4 files			
	Warm-water heater	1600W			
	Safety device	Thermal fuse, bimetal thermostat, temperature sensor			
Thermal seat	Surface temperature	A temperature of 4 gears			
	The heater of seat	45W			
	Safety device	Thermal fuse, temperature sensor			
Dry	The temperature of warm wind	The wind temperature 4 files			
	Heater of warm wind	250W			
	Safety device	Temperature fuse, bimetal thermostat			
Water pressure		Water pressure of water supply 0.15MPa-0.75MPa			
Waterproof level		IPX4			
Supply water temperature		4 1 - 1 0 4 °F			
Ambient temperature		3 2 - 1 0 4 °F			
Product size		685mm * 410mm * 480mm (L*W*H)			
Product weight		About 42kg			
Product implementation standards		GB 4706.53-2008 GB 4706.1-2005 GB/T 6952-2015			
The identification of water efficiency marks the water consumption and water efficiency grade according to GB 38448-2019 standard Note: 1. The water efficiency grade of our water closet meets the requirements of GB 38448-2019 "Minimum Allowable Values and Grades of the Energy Efficiency and Water Efficiency for Smart Water Closets", and the water efficiency grade indexes of water closets are as follows:					
Energy efficiency and water efficiency grade of smart water closet		Grade 1	Grade 2	Grade 3	
The index of energy efficiency grade	Energy consumption in one period/(kwh)	Heating function with seat	≤0.030	≤0.040	≤0.060
		Heating function without seat	≤0.010	≤0.020	≤0.030
The index of water efficiency grade	Average water supply volume for cleaning of smart water closet (L)	≤0.30	≤0.50	≤0.70	
	* Average water consumption for flushing of smart water closet (L)	Meet the standard requirements of Grade 1 in GB 25502	Meet the standard requirements of Grade 2 in GB 25502	Meet the standard requirements of Grade 3 in GB 25502	
	* The water consumption for cleaning and thorough washing of double flush smart water closet(L)				
Note 1: *** Applicable to integrated smart water closet. Note 2: The average water consumption of half flush of double flush smart water closets in each water efficiency grade should be less than 70% of its maximum limit value for total flush water consumption. 2. The barcode on the products and outer boxes of our company is only used for internal use, not for other purposes.					

## Quality Guarantee

Our company will guarantee the quality of products according to the contents of this warranty. Please fill in the guarantee and contact the serve center of our company when products are in malfunction.

Model:		Code:	
Name:			
Company:			
Address:			
City:		Nationality:	
Tel:	Fax:	E-mail :	
Purchase outlet (seal):			
Address:			
Installation date:			
The guarantee period shall be within 1 year from the date of installation			

The guarantee should be filled in and kept properly after confirming the style and content when purchasing.

### The regulations of free maintenance

- If the products are in malfunction after they are used in accordance with specification and matters needing attention, the maintenance is free during the warranty period.
- Please contact purchase outlet and customer service center troubleshooting in warranty period and present guarantee when repairing.
- The following situations should be charged for maintenance even though in warranty period.
  - The faults caused by inattention or negligence when using and the faults caused by wrongful repairs or transformation.
  - The faults or damage caused by moving the location of installation.
  - The faults and damage caused by fire, earthquake, flood, thunder and other natural disasters, public hazards or abnormal voltage.
  - The faults or damage caused by the use of unspecified power source (voltage, frequency).
  - The faults and damage caused by using for other purposes instead of using for general family.
  - Conditions that can't show this guarantee.
  - There is no customer name, purchase outlet, the date of installation and other contents or the contents are modified without permission in the guarantee.
- This guarantee is only valid in China.
- This certificate will be not issued any more and please keep it properly.

### About Services

#### The Power of Customers

Customers has the right of repairing faults free of charge in 1 year from the date of installation. However, the faults caused by negligence of customers and natural disasters should be charged for maintenance even though in the warranty period.

# Installation instruction

## 1 Safety precautions

The representation graph and its meaning are as follows :

	Warning	It means that if the products was used improperly, the users will dead or be injured seriously.
	Note	It means that improper use of products may cause users get injured or suffer material loss.
	Disassemble prohibited	It means splitting or transforming the main body is forbidden.
	Required	It means "must abide by" and the left figure representing must observe strictly.

Note

Prohibition Treading, striking or putting heavy stuff on seat, cover sheet and main body is forbidden, which may cause injury or water leakage.

Required Please use the specified accessories when installing.

## 2 Precautions of installation environments

### 1 Installation space

Please confirm whether the switches of doors will influence the installation of products when ensuring the installation space.

- The water supply pipeline shall be more than 150mm away from the ground.
- Otherwise, it may change the color of the wall space.

The existence of the location of water supply and settled location of PVC tube pipe shall be confirmed before installing.

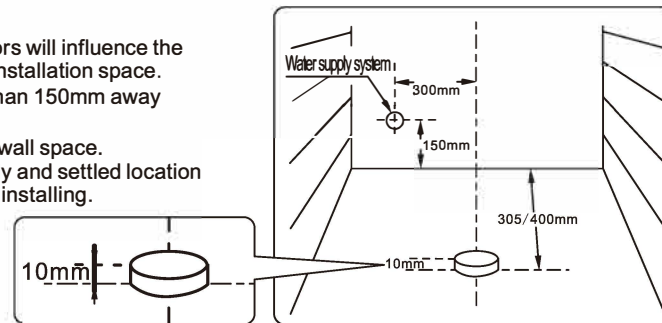

### 2 Water pressure

The minimum water pressure is 0.15 MPa. If the requirement cannot be met, the foreign matter cannot be flushed out of the water closet.

Water pressure must reach more than 0.15 MPa when using with other faucets simultaneously. The maximum water pressure is 0.75 MPa.

If there is no water pressure test device,

measurement essentials of minimum water pressure

If there is no water pressure test device, the ways in the right figure can be utilized to measure water pressure.

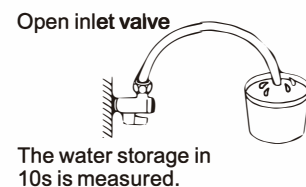

The water storage in 10s is measured.

The minimum water pressure of products can be ensured if water volume is more than 3.5L.

Please prepare water storage for standby application.

# Installation instruction

## 3 Installation drawings (unit: mm)

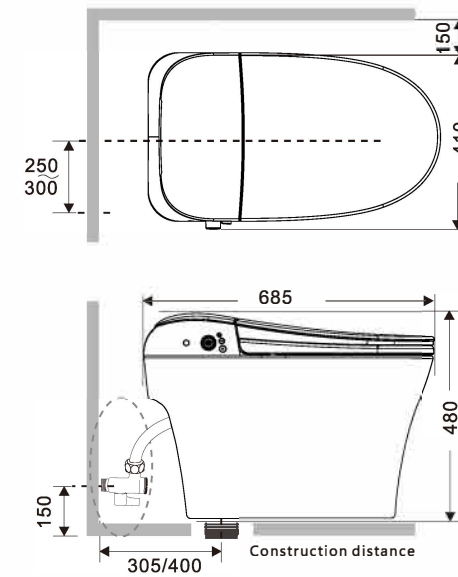

## 3 Others

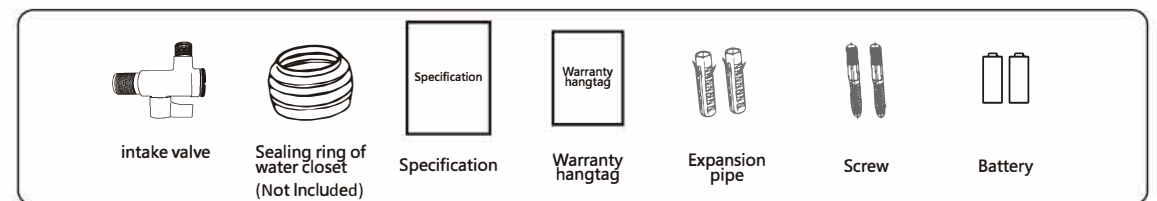

# Installation instruction

## 4 Name and Installation of All Parts

1. Close valve.
2. Please rinse the dust or sand in water inlet when installing inlet valve.
3. Inlet valve and nut of water inlet are wrapped with waterproof tape
4. The installation part should be screwed up carefully.
  - Pay attention to tightening the joint part of the filter screen. (May cause water leakage)

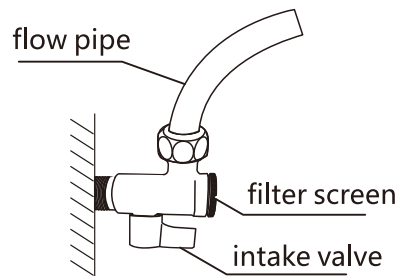

### ④ Connect the water supply pipe

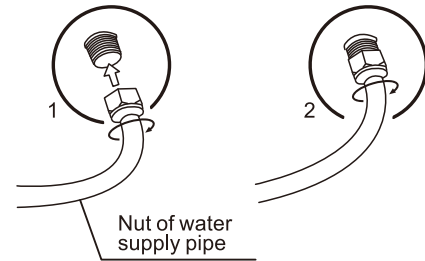

1. Connect the water supply pipe with the water inlet valve.
2. Nut of water supply pipe is rotated clockwise and screwed up.

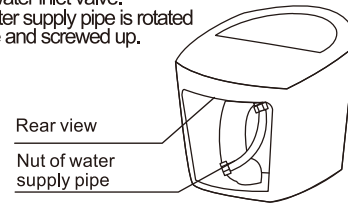

New hose assemblies attached to appliance should be used, while old hose assemblies cannot be recycled.

### ② Assemble the sealing ring of water closet

The sealing ring of water closet is installed in sewage draining exit of water closets.

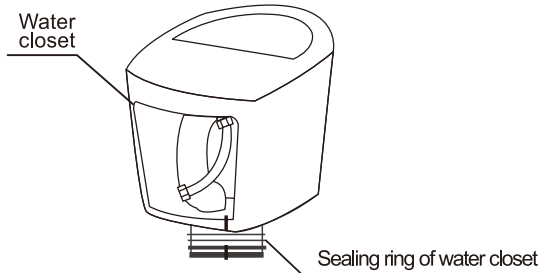

### ③ Assemble the sealing ring of water closet

1. The height of PVC drainage pipe is adjusted to 10mm off the ground and keep horizontal.
2. The toilet bottom of sealing ring of pedestal toilet that has been installed shall be connected with drainage pipe.

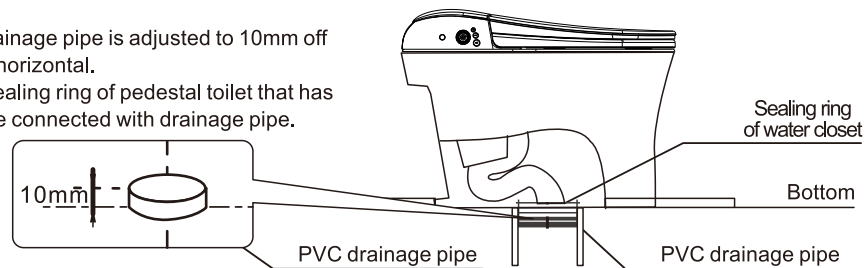

# Installation instruction

### ⑤ Silica gel daubing

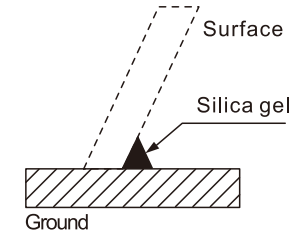

The bottom of the water closets and the intervals of the ground may contaminate floor because of water seepage when cleaning, so daubing silica gel on the bottom of seats to prevent water seepage is suggested.

### ⑥ Open water inlet valve(the source of water and water meter)

Rotate clockwise to open inlet valve.

### ⑦ Bracket installation

1. The protective film of adhesive sticker on the back of remote control pylons shall be torn off and then pylons shall be pasted in suitable wall space.
2. Two positions shall be drilled on the wall, which are the holes that embrace the same distance with permanent seat of remote control, and then intumescent colloidal particle shall be put into holes by hammer. And then the permanent seat shall be fixed on the wall with cap screws.

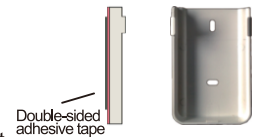

### ⑧ Power source connection

1. Connect the plug to the electrical outlet.
2. Press the flush button on remote control
  - There would be water in ceramic.
  - (Before the first use, normal water seal will be formed after flushing to reach normal flush function.)

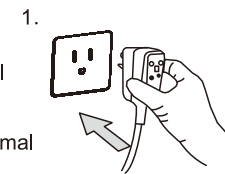

2.



Water may splash out or overflow in the place with higher water pressure when flushing.  
- So the inlet valve shall be rotated clockwise to turn down water pressure.

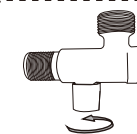

The valve shall be rotated clockwise to turn down water pressure.