

## SILVER SOL QUEEN BED

---

### ASSEMBLY INSTRUCTION



# Assembly Instruction

## ASSEMBLY TIPS:

1. Remove hardware from box and sort by size.
2. Please check to see that all hardware and parts are present prior startof assembly.
3. Please follow attached instructions in the same sequence as numbered to assure fast and easy assembly.











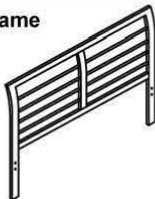
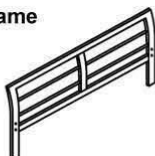



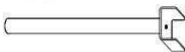



### Warning !

1. Don't attempt to repair or modify parts that are broken or defective. Please contact the store immediately.
2. This product is for home use only and not intended for commercial establishment.

## PARTS IDENTIFICATION:

## Z: HARDWARE PACKAGE:



NO	DESCRIPTION & FIGURE	QTY
A	Headboard Frame 	1 pc
B	Footboard Frame 	1 pc
C	Side Rails 	2 pcs
D	Base Frame Retainers 	2 pcs
E	Middle Support Rail 	1 pc
F	KD Long Support Leg 	3 pcs
G	Wooden Slat 	28 pcs
H	KD Short Support Leg 	2 pcs

NO	DESCRIPTION	FIGURE	QTY
1	Bolt (M6 x 30MM)		8 pcs
2	Bolt (M6 x 40MM)		7 pcs
3	Cap Nut (M6 x 20MM)		4 pcs
4	Stud Screw		5 pcs
5	Side Slat Stopper		28 pcs
6	Center Slat Stopper		14 pcs
7	Spring Washer (M6)		8 pcs
8	Allen Key (M4)		2 pcs
9	Washer		17 pcs
10	Bolt (M6 x 60MM)		2 pcs

It needs two persons and takes about half an hour to assemble the item.

**Step 1**

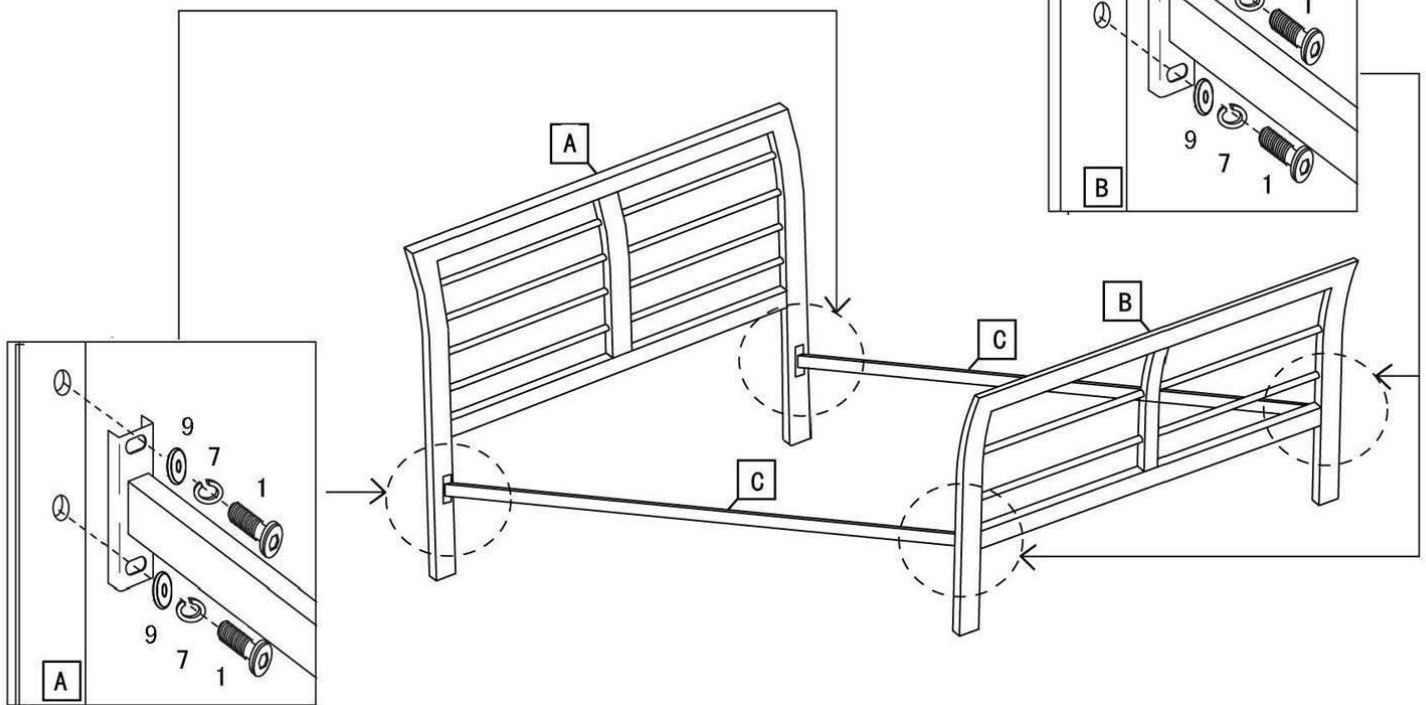

Attach the Side Rails (C) to Headboard (A) and Footboard (B) by Bolt (1), (7) and (9) tighten with Allen Key (8) as Shown in the Picture.

1		8 PCS
7		8 PCS
9		8 PCS



**Step 2**

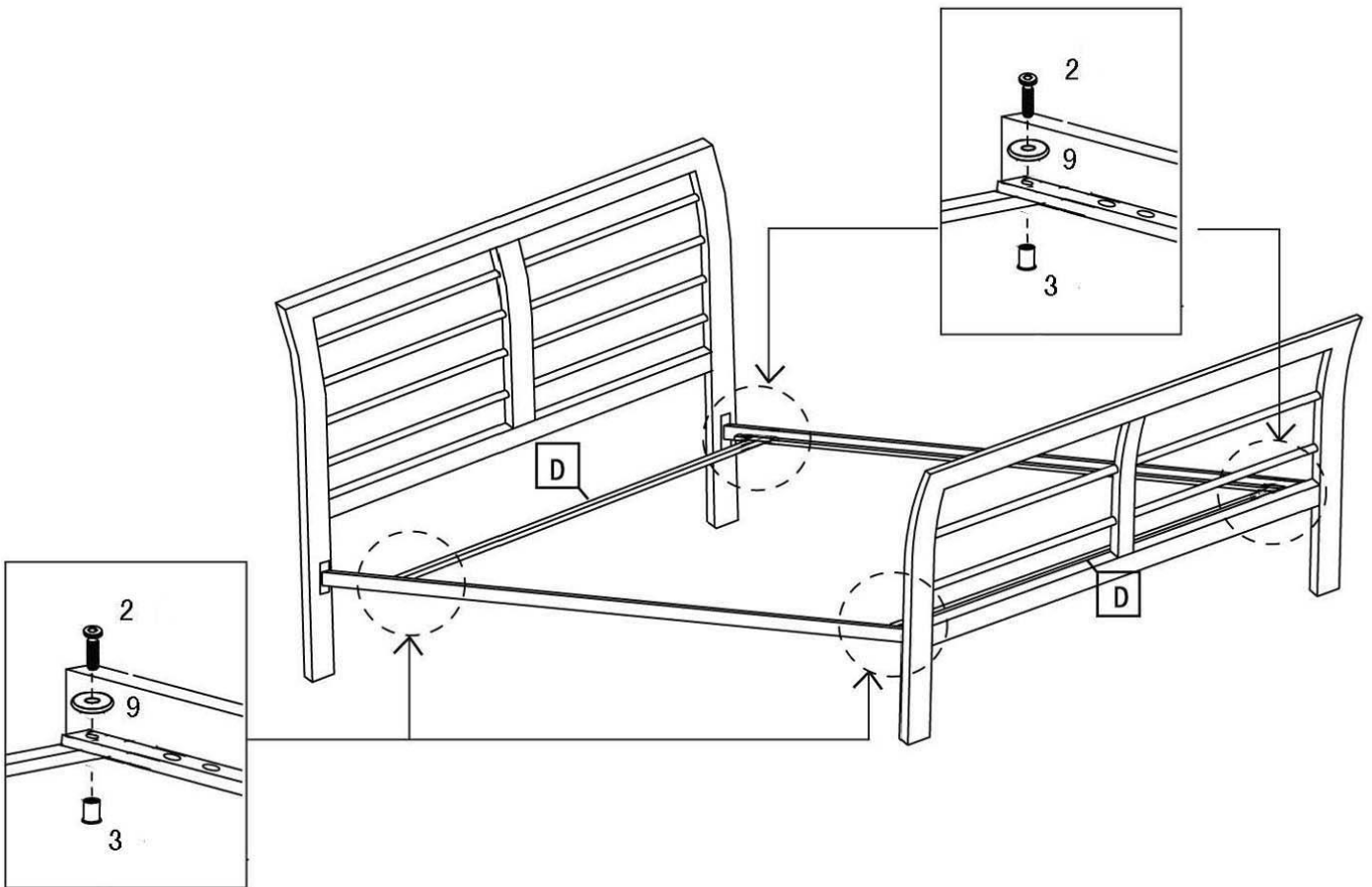

Attach the Base Frame Retainers (D) to Side Rails (C) by Bolt (2), Washer (9) and Cap Nut (3) tighten with Allen Key (8) as Shown in the Picture.

2	
Bolt M6 x 40mm	4 PCS
3	
Cap Nut M6 x 20mm	4 PCS
9	
Washer	4 PCS



**Step 3**

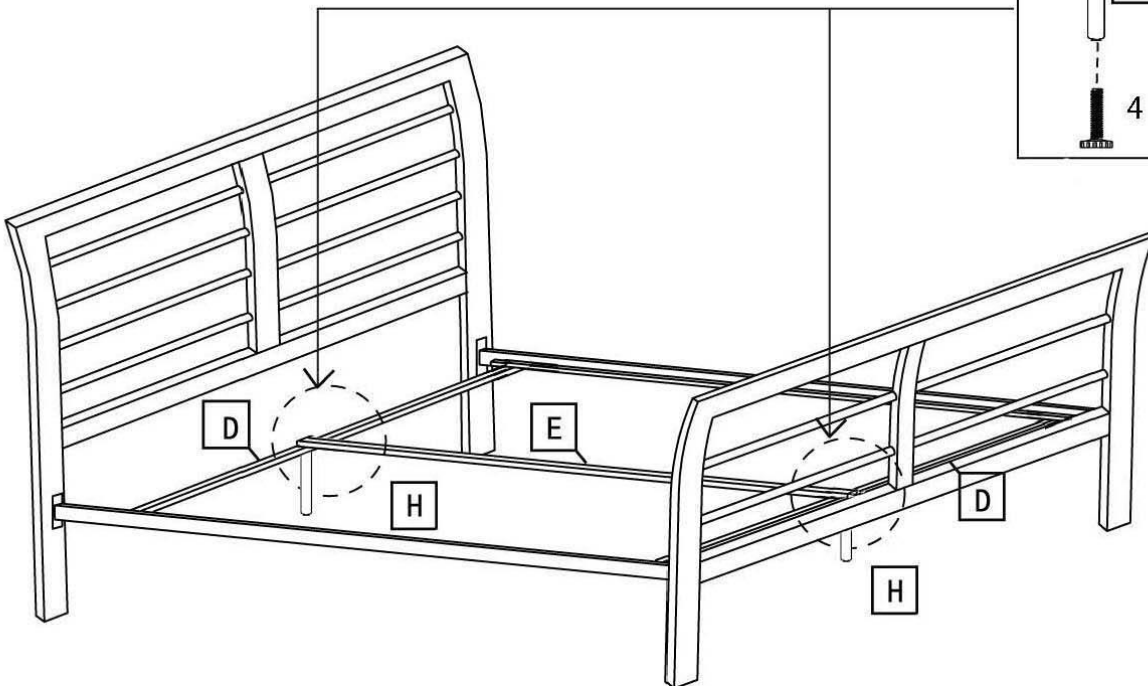
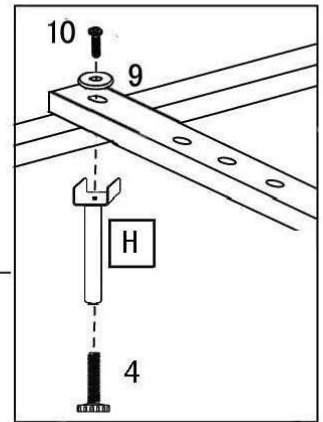

Attach Stud Screw (4) to KD Support Legs (H). Attach KD Short Support Legs (H) to Middle Support Rail (E) by Bolt(10) and Washer (9) tighten with Allen Key (8) as Shown in the Picture.

10		
	Bolt M6 x 60mm	2 PCS
4		
	Stud Screw	2 PCS
9		
	Washer	2 PCS



**Step 4**

Attach Stud Screw (4) to KD Support Legs (F). Attach KD Long Support Legs (F) to Middle Support Rail (E) by Bolt (2) and Washer (9) tighten with Allen Key (8) as Shown in the Picture.

2		
	Bolt M6 x 40mm	3PCS
4		
	Stud Screw	3PCS
9		
	Washer	3PCS

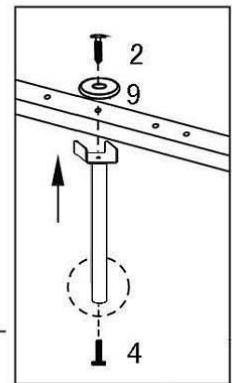
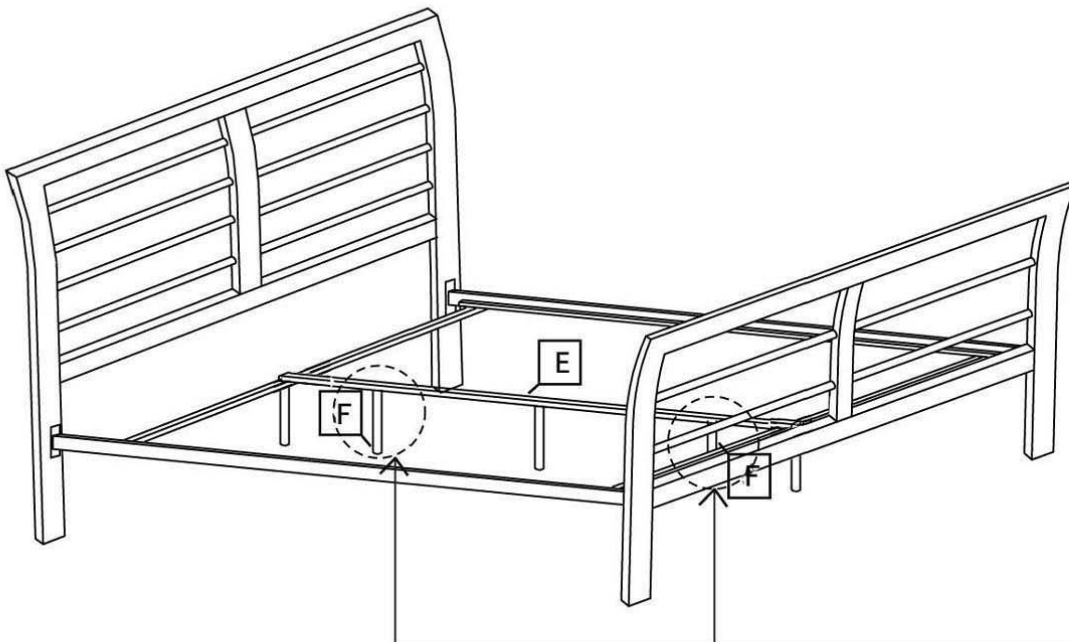

## Step 5

Insert the Wooden Slats (G) with fixed Slat Stopper (5) & (6) into between the Side Rails (C) and to fix stopper firmly into the hole on the Side Rails (C) as Shown in the Picture.

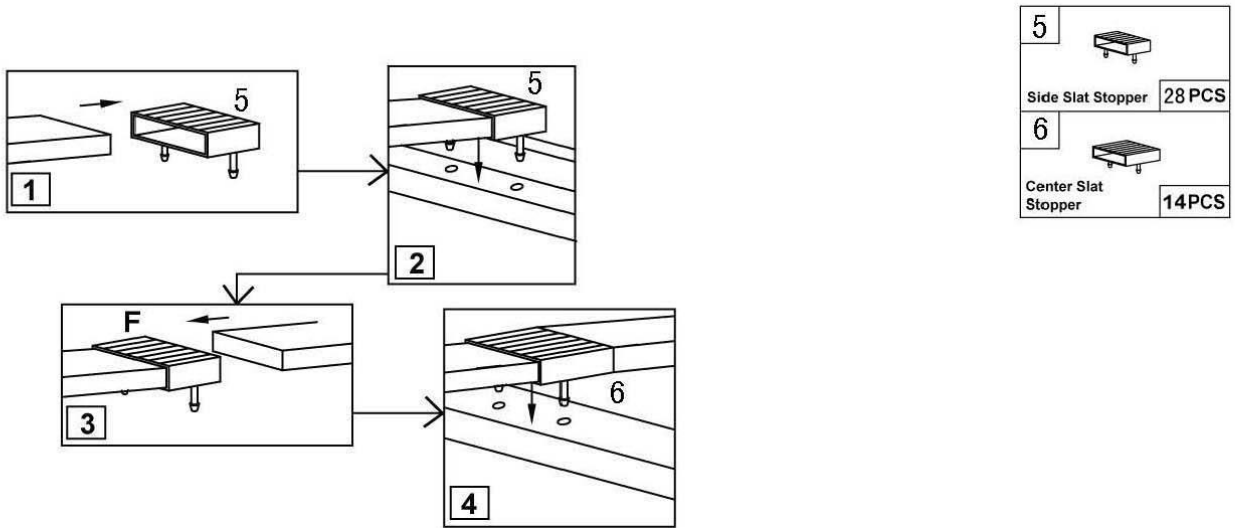

### Note:

Please check and fully tighten all the fittings at this stage.

