

WARNING (To reduce the risk of fire, electric shock, or injury to persons):

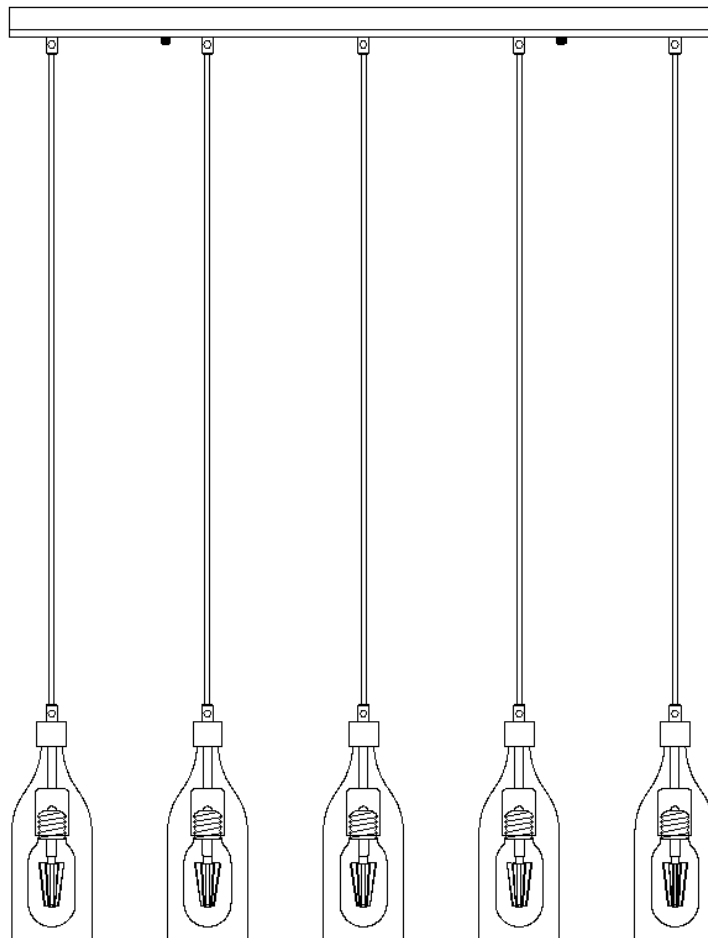



1. We suggest installation by a **licensed electrician**.
2. Please read the instruction carefully and save it as you may need it at later time.
3. Before you start, **NEVER** attempt any work without shutting off the electricity until the work is done. A). Go to the main fuse, or circuit breaker, box in your home. Place the main power switch in the “**OFF**” position. B). Place the wall switch in the “**OFF**” position.
4. Mounting surface should be clean, dry, flat, strong enough and 1/4” larger than the canopy on all side. Any gaps between the mounting surface and canopy exceeding 3/16” should be corrected as required.
5. Make sure that the ceiling or wall can stand the weight of the lamp before fixture.
6. Make sure the voltage you are using is **120V**. The maximum wattage is **40W** per bulb.
7. Keep the lamp away from acidic and basic objects in case of damaging the surface of the lamp.
8. When replacing bulb, you should turn off or unplug the lamp and you must wait until it is cool as bulbs get hot quickly.
9. The safety instructions appearing in this manual are not meant to cover all possible conditions that may occur. It must be understood that common sense, caution and care must be used with any electrical products.

IMAGE FOR FINISHED PRODUCT:

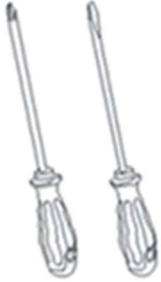

TOOLS REQUIRED (NOT INCLUDED):

Before doing assembly and installation please prepare the needed tools as below picture

				
Ladder	Phillips head, flat blade screwdriver	Electrical tape	Portable driller	Hammer

PARTS TYPE & QTY INCLUDING:

- (M) Glass shade (5)
- (C) Strain relief (10)
- (D) Cord (5)
- (F) Mounting plate (1)
- (G) Green ground screw (1)
- (I) Canopy (1)
- (J) Ball knob (2)
- (L) Socket cap (5)

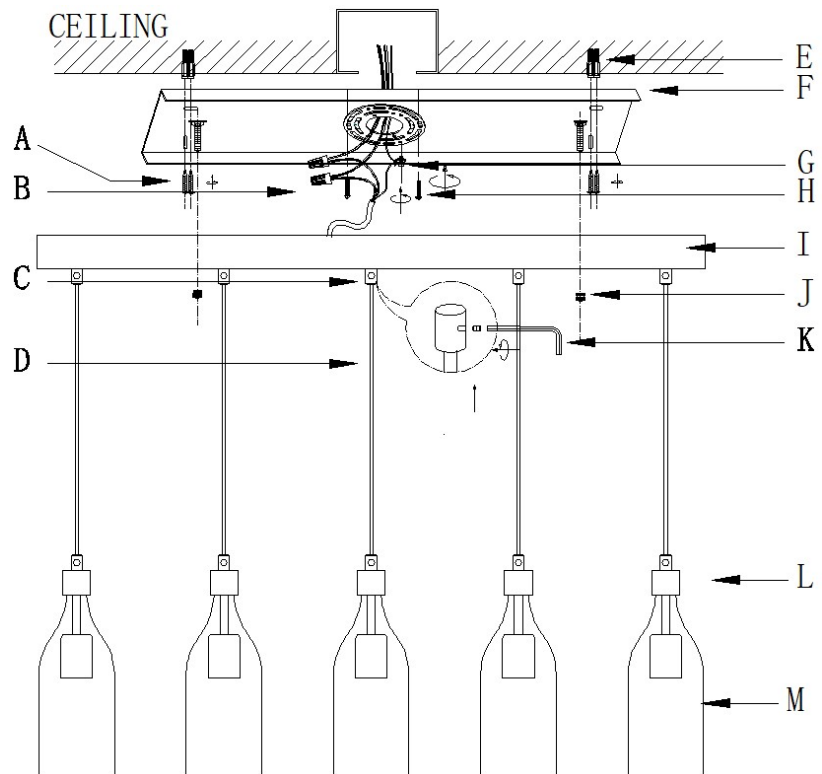

ACCESSORIES & QTY ENCLOSED:

- (A) Wood screw (4)
- (B) Plastic Wire Connector (3)
- (E) Plastic anchor (4)
- (H) Mounting screw (2)
- (K) Allen wrench (1)

ASSEMBLY & INSTALLATION INSTRUCTIONS:

1. Carefully remove the fixture from the carton and check that all parts and accessories are included as shown in the above illustration
2. Turn off power
Before you start to make installation, NEVER attempt any work without shutting off the electricity until the work is done. A). Go to the main fuse, or circuit breaker, box in your home. Place the main power switch in the "OFF" position. B). Place the wall switch in the "OFF" position.

3. Make installation

A1: Carefully remove the protection pad from glass shades(M), then install bulbs(Not included. Please do not exceed the maximum capacity recommended on the socket.)

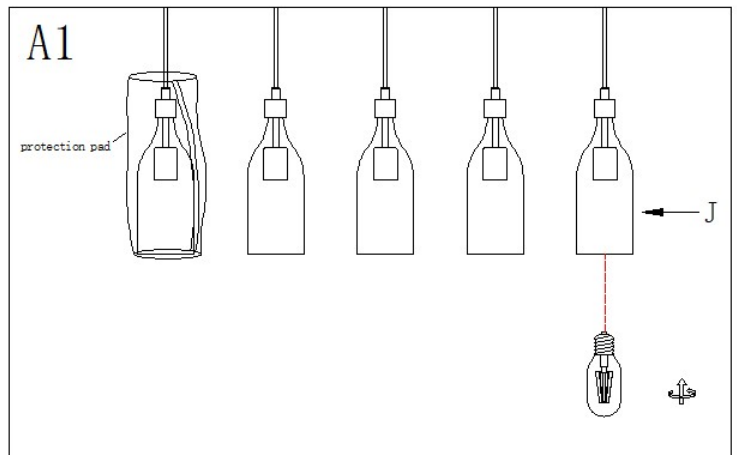

A2: Unscrew the ball knobs (J) from the canopy (I), then gently remove the mounting plate(F) from the canopy (I)

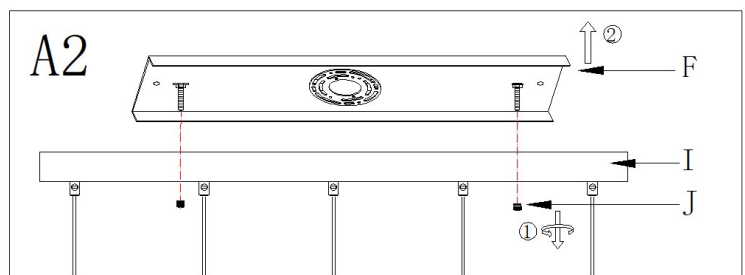

A3: Adjust the length of the cords to achieve the desired height of the mounted fixture.

1. Use the allen wrench(K) to unscrew the screw in the strain relief(C), carefully pull cord(D) up or down to lengthen or shorten cord.
2. Once desired height of fixture is achieved, carefully tighten the screw

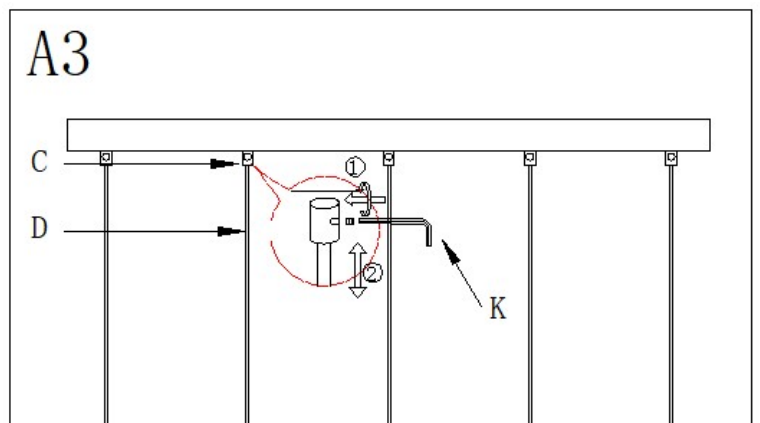

A4: Secure the mounting plate (F) to outlet box with mounting screws(H), anchors (E) and wood screws(A).

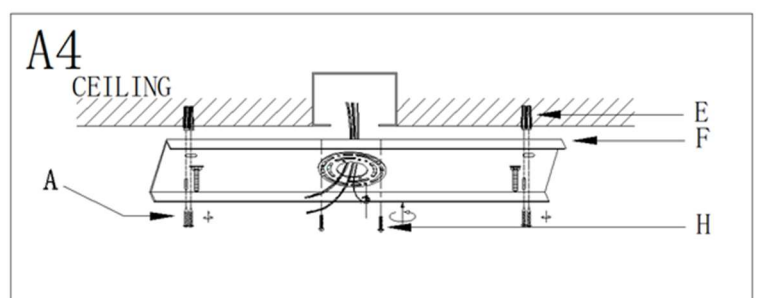

4. Make wire connections

Connect wires as below wires connecting shown. **TAKE NOTE OF YOUR COLOR OF FIXTURE , NEVER CONNECT WIRES TO GROUND WIRES**

Connect ground wire according to below chart

Connect wires according to below chart

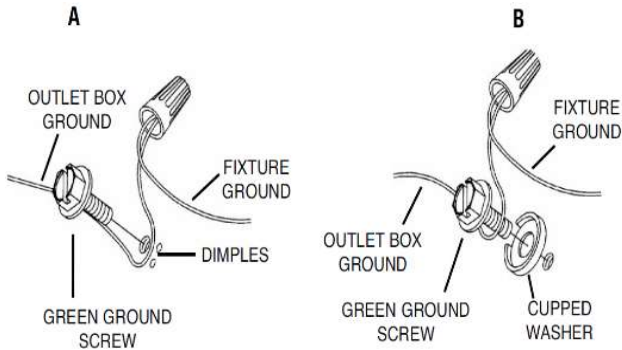

Connect Black or Red Supply Wire to:	Connect White Supply Wire to:
Black	White
*Parallel cord (round & smooth)	*Parallel cord (square & ridged)
Clear, Brown, Gold or Black without tracer	Clear, Brown, Gold or Black with tracer
Insulated wire (other than green) with copper conductor	Insulated wire (other than green) with silver conductor

*Note: When parallel wires (SPT I & SPT II) are used. The neutral wire is square shaped or ridged and the other wire will be round in shape or smooth (see illus.)

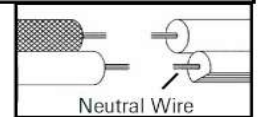

Twist plastic wire connector until wires are tightly joined together, wrap each connector with approved electrical tape and carefully stuff all wires into the outlet box and the canopy(I)

A5: Align the holes in the canopy (I) with the mounting screws, then attach the canopy (I) using the previously removed ball knobs (J). Hand tighten until snug. **Before this step, in order to avoid damage by swing or bumping when to hang the glass shades(M).our recommend to trap the glass shades(M) with protection pads.**

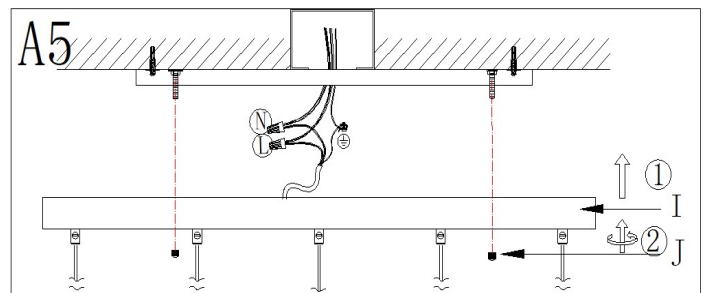

A6: Carefully remove the protection pads from Glass shades (M)

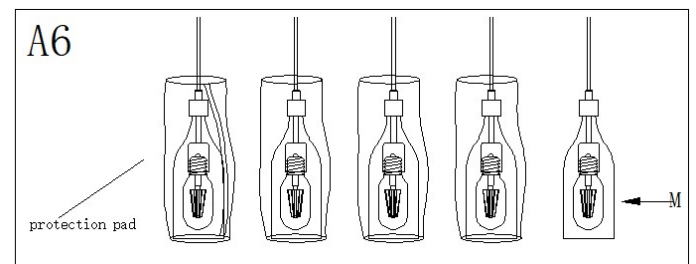

4. Check everything installed properly, then you could turn on the light. Enjoy!

CLEANING

To clean, wipe fixture with a soft cloth. Clean glass with a mild soap. Do not use abrasive materials such as scouring pads or powders, steel wool or abrasive paper.

ORDERING PARTS

Keep this sheet for future reference, and in case you need to order replacement parts. All parts for this fixture can be ordered from place of purchase. Be sure to use exact wording from illustration when ordering parts.