

# INSTRUCTIONS

---

## Office chair

Thank you very much for purchasing this product. We sincerely appreciate your support. Before use, please read this manual carefully to fully understand its contents and follow the correct assembly and usage instructions. Additionally, please keep this manual properly for future reference.



<b>Content</b>	<b>page</b>
Important notice(Safety precautions)	1~2
Accessories list	3
Assembly steps	4
Usage instructions	5
Maintenance method	5
Product specifications	6

# IMPORTANT NOTICE(SAFETY PRECAUTIONS)

In order to prevent users or others from suffering harm and economic losses, this manual records the important contents to ensure safe and correct use.

Please read this manual carefully based on the understanding of the following content (indicated by sign/ circular symbols), and strictly abide by the matters mentioned herein.

- Sign the instructions  
Classify it according to the degree of harm or loss caused by the wrong use.



 <b>WARN:</b> Content that may cause death or serious injury (※1).	 <b>NOTICE:</b> The label indicates that the harm(※2) or material loss(※3) caused by the misuse is classified.
---	---

- Figure symbol description  
The graphic symbols are explained by the following graphic symbols.  
(The following is a graphic symbol example.)

 Do not execute, "prohibited" matters. Strictly observe, "enforce" compliance	 Strictly adhere to the matters that are "compulsory" to comply with.
---	--

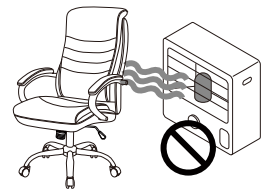

- ※1 The so-called serious injury refers to injuries that result in disabilities such as blindness, or injuries, burns, fractures, poisoning, electric shock, etc., which leave aftereffects and require hospitalization for treatment, as well as injuries that necessitate long-term medical care.
- ※2 The so-called injury refers to injuries that do not require treatment or hospitalization, long-term medical care, burns, scalds, etc.
- ※3 The so-called material loss refers to the associated losses related to housing, furniture, and property.





	 <b>WARNING</b>
 <b>Prohibited</b>	<ul style="list-style-type: none"> <li>● Please keep all packaging materials out of reach of infants and young children, as they may pose a risk of suffocation if they cover the head or obstruct breathing.</li> <li>● Do not adjust the swing intensity too loosely. Excessive looseness may cause the adjustment bolt to fall off or the backrest to shift, potentially leading to injury.</li> <li>● Do not place the product near heating equipment or open flames. Also, avoid using or storing it in high-temperature environments. Failure to do so may cause the gas cylinder to rupture, leading to injury, burns, or fire hazards.</li> <li>● Do not use the product with more than one person at a time. Doing so may result in falls, product damage, or injury.</li> <li>● Do not stand on the seat, sit in reverse on the chair, or sit on parts other than the seat, such as the armrests (sold separately) or backrest. Doing so may result in falls, product damage, or injury.</li> <li>● Do not sit on the edge of the seat or tilt the chair. Doing so may result in falls, product damage, or injury.</li> <li>● Do not use the product on sloped or uneven surfaces. Doing so may result in falls and injuries.</li> <li>● Do not let cigarette ashes or other burning materials fall onto the product, as this may cause a fire.</li> <li>● Be careful not to let the product's casters or other parts press on electrical appliance power cords. Doing so may damage the cord, leading to electric shock or fire.</li> <li>● If any part of the product becomes loose or abnormal, stop using it immediately. Continuing to use it may cause damage or injury.</li> <li>● Do not allow children to use the product unsupervised. Doing so may result in accidental injury.</li> <li>● Do not allow children to operate the adjustment mechanisms. Improper use may result in injury.</li> <li>● Do not allow infants or young children to sit or lie on the product. Doing so may result in falls, suffocation, or other accidental injuries.</li> </ul>

# IMPORTANT NOTICE(SAFETY PRECAUTIONS)

## ⚠ WARNING

 <b>Forbidden</b>	<ul style="list-style-type: none"> <li>● Do not disassemble the air pressure column. Otherwise, it may cause rupture and injury.</li> <li>● When scrapping, do not throw into the fire. Otherwise, it may cause the air pressure column to burst or produce toxic gases.</li> <li>● When scrapping, please dispose of it in accordance with the official regulations of the respective regions.</li> </ul>	
---	--	--











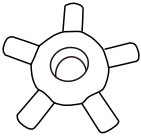

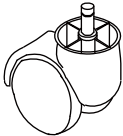
## ⚠ ATTENTION

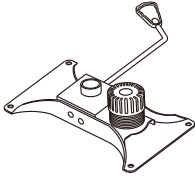
 <b>Forbidden</b>	<ul style="list-style-type: none"> <li>● Do not use outdoors. Otherwise, it may cause deformation or severe deterioration, and personal injury.</li> <li>● Do not place in a humid environment for a long time (with reference to humidity above 70% and room temperature at C degrees or above), otherwise it may cause mold or mite breeding, which could harm health.</li> <li>● Do not operate the lifting rod when no one is seated. Otherwise, the seat may suddenly rise and cause injury.</li> <li>● Do not insert fingers or other objects into the rotating parts or their gaps. Otherwise, you may be caught and injured when they are moving.</li> <li>● When moving, do not let it drop. Otherwise, it may cause damage to the product or the floor.</li> <li>● Do not use for purposes other than its intended use, such as transportation. Otherwise, it may cause accidental accidents or injuries.</li> <li>● Do not disassemble or modify on your own. Otherwise, it may cause a decrease in product strength and personal injury.</li> <li>● Do not use lubricants or other sprays or oils. Oil droplets may stain the floor or clothing.</li> </ul>
 <b>Strictly adhere</b>	<ul style="list-style-type: none"> <li>● When first using, please ensure that the room is well ventilated. Adhesives may contain formaldehyde residues, which can easily lead to allergic reactions in those with chemical sensitivities.</li> <li>● If the floor is made of soft materials such as wood, Please ensure lay down carpets or similar to protect the floor. Otherwise, the casters may cause dents or damage to the floor.</li> <li>● Please make sure to check the chair's position before sitting down. When used on slippery surfaces, the casters can make the chair slide easily, which may lead to falls and accidental injuries.</li> <li>● Please frequently check for any loosening or shaking of the casters, screws, and other metal parts, and sustained use them securely when loose. Continuous use without checking can cause damage or injury.</li> </ul>

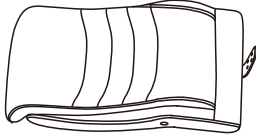
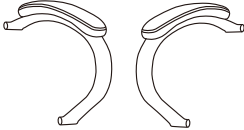
## REQUEST (OTHER NOTES)

	<ul style="list-style-type: none"> <li>● Do not press down on the lift lever. Otherwise, it may cause damage and malfunction.</li> <li>● During maintenance, please do not use organic solvents or bleaching agents. Otherwise, it may cause discoloration or deformation.</li> </ul>
--	---

# ACCESSORIES LIST

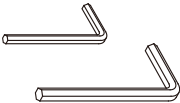
<p>A. KD base core x 1</p> 	<p>B. KD base leg x 5</p> 	<p>C. Caster x 5</p> 	<p>D. Gas lift x 1</p> 
<p>E. Mechanism x 1</p> 	<p>F. Seat x 1</p> 	<p>G. Backrest x 1</p> 	<p>H. Armrest x 2</p> 
<p>I. Screw M6*10 x 10</p> 	<p>J. Screw M6*20 x 4</p> 	<p>K. Screw M6*30 x 4</p> 	<p>L. Screw M8*50 x 4</p> 
<p>M. Washer x 4</p> 	<p>N. Allen key x 2</p> 		

# ASSEMBLY STEPS



During assembly, make sure that at least two people work together. Assembling alone may result in product damage or accidental injury due to falling parts. Do not use power tools during assembly, as excessive force may damage the product and cause injury.

- 1** Attach the KD base legs (B) to the KD base core (A) using screws (I).

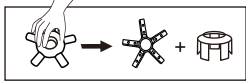

Need to remove  first  
But don't discard it. It will  
be needed in the next step.

Tighten

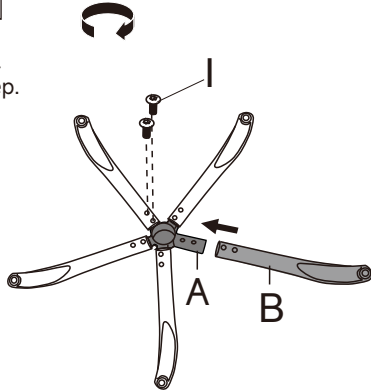

- 2** Press swivel casters (C) firmly into KD base legs until they click. Align gas lift (D) vertically with center hub cover onto KD base.

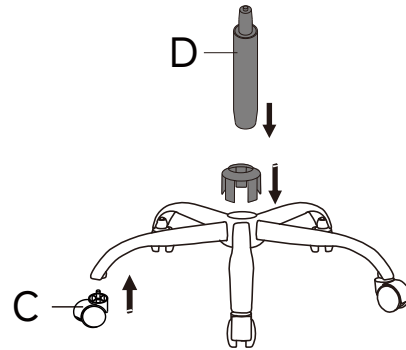

- 3** Install mechanism (E) onto the seat (F) using screws (J).

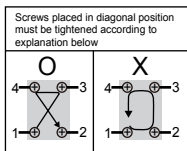

Screws placed in diagonal position must be tightened according to explanation below

Tighten

Firstly temporarily tighten the screws to about 80%, then fully tighten the screws to 100%.

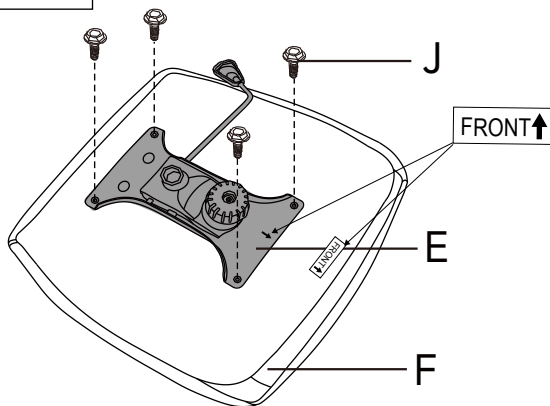

- 4** Secure the backrest (G) to the seat using screws (K).

Tighten

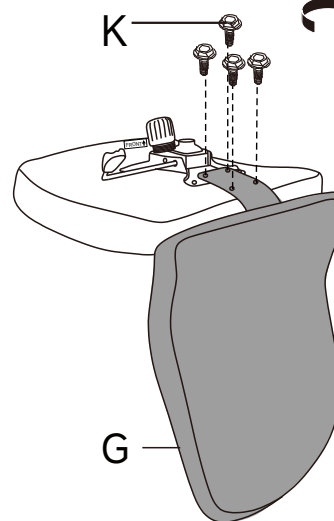

Firstly temporarily tighten the screws to about 80%, then fully tighten the screws to 100%.

- 5** Assemble the installed base and seat.

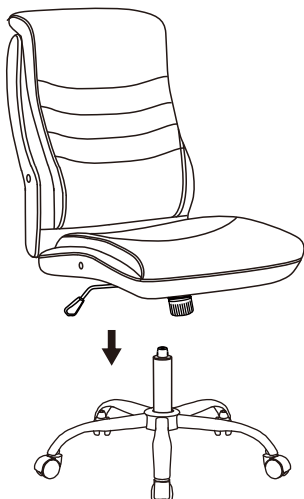

- 6** Mount the armrests (H) onto the seat and backrest using screws (L), and plug (M).

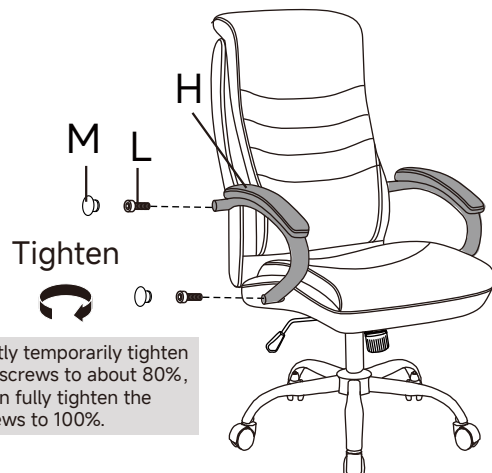

Firstly temporarily tighten the screws to about 80%, then fully tighten the screws to 100%.

# USAGE INSTRUCTIONS

## ■ Adjusting the Seat Height

You can adjust the seat height by operating the lifting handle beside the seat.

- When raising the seat:



Pull the lifting handle upward, gently rise from the seat to raise the chair. Release the lifting handle at the desired position to lock it in place.

- Lower the seat when sitting on the seat vertically and applying weight, pull up the lifting handle to lower the seat. Release it at the appropriate position to secure it in place.

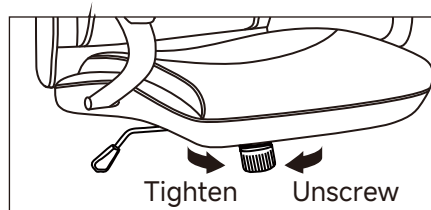

## ■ Adjusting tilt lock

- Push the lifting handle “in” towards the chair to lock which will lock the backrest and prevent from tilting.
- Pull the lifting handle “out” from the chair to unlock which will unlock the backrest and allow for tilting.
- **Adjust tilt tension:** Turn the handwheel clockwise for firmer recline, counterclockwise for easier leaning. Keep lifting handle locked when not adjusting.



 <b>Attention</b>	When adjusting the handwheel, do not loosen it too much. If you rotate too much to the right (too loose), the adjustment handwheel will fall off, and the back of the chair may be offset and injured
 <b>Forbidden</b>	





 <b>Attention</b>	Do not operate the lifting handle when no one is seating.
 <b>Forbidden</b>	Making adjustments when no one is seating may cause injury by causing the seat surface to rise suddenly.

<b>Request (Other precautions)</b>	Do not press down on the lifting handle rod, otherwise it may cause damage and failure
--	--

## ■ About scrapping

- When scrapped, please deal with it in the manner

 <b>Attention</b>	 <b>Forbidden</b>	Do not put the pressure rod into the fire. Failure to do so may result in rupture or the production of toxic gases
---	---	---

# MAINTENANCE METHOD

## Maintenance inspection

- Please frequently check the metal parts such as pulleys and screws for any loosening. If any loosening is found, please retighten them to prevent injury, damage to the product, or scratching the floor.
- Please regularly check if all parts are not loose or shaking, and immediately stop using if any abnormalities are found, otherwise it may lead to product damage or injury.

## Canvas maintenance

- During daily maintenance, please use a brush or vacuum cleaner (low wind) to remove dust and other debris from between the fabric textures.
- If stained with coffee, alcohol, or other severe dirt, please dilute a neutral detergent with warm water at a concentration of 3-5%, soak a soft cloth, wring it out, and then gently tap the surface. After that, wring out the cloth with clear water, wipe it clean again, and allow it to air dry naturally.

## Maintenance of Plastic/Metal Parts

- During daily maintenance, please use a soft dry cloth to wipe.
- When dirt is severe, please use a neutral detergent diluted to 3-5% to moisten a soft cloth, then wipe off the dirt. Next, use a cloth moistened with clear water to wipe away the detergent, and finally, gently wipe with a soft dry cloth and allow it to air dry naturally.

# PRODUCT SPECIFICATIONS

---

<b>Product Name</b>	Office chair
<b>Product dimensions</b>	W24.02*D27.95*H44.09-48.03 inch
<b>Product weight</b>	About 39.60 lbs
<b>Purpose</b>	Chair(single use)
<b>Original production country</b>	China