











ASSEMBLY INSTRUCTION

Thank you for purchasing this quality product. Be sure to check all packing material carefully for small parts which may have come loose inside the carton during shipment. Separate, identify and count all parts and metal hardware. Compare with parts list to be sure all parts are present. If any part(s) are missing or damaged, please contact your local furniture dealer. For efficient and speedy service, please indicate the model number and code letter of part(s) needed.

***** Do not fully tighten screws until fully assembled *****

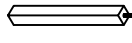
PARTS LIST				HARDWARE LIST			
NO	DESCRIPTION	SKETCH	QTY	NO	DESCRIPTION	SKETCH	QTY
A	HEADBOARD		1 Pc	1	BOLT		8 Pcs
B	FOOTBOARD		1 Pc	2	FLAT WASHER		8 Pcs
C	RAILS		2 Pcs	3	HEX NUT		8 Pcs
D	SLATS		3 Pcs	4	WRENCH		1 Pc
E	SUPPORT LEGS		3 Pcs	5	SCREW		6 Pcs

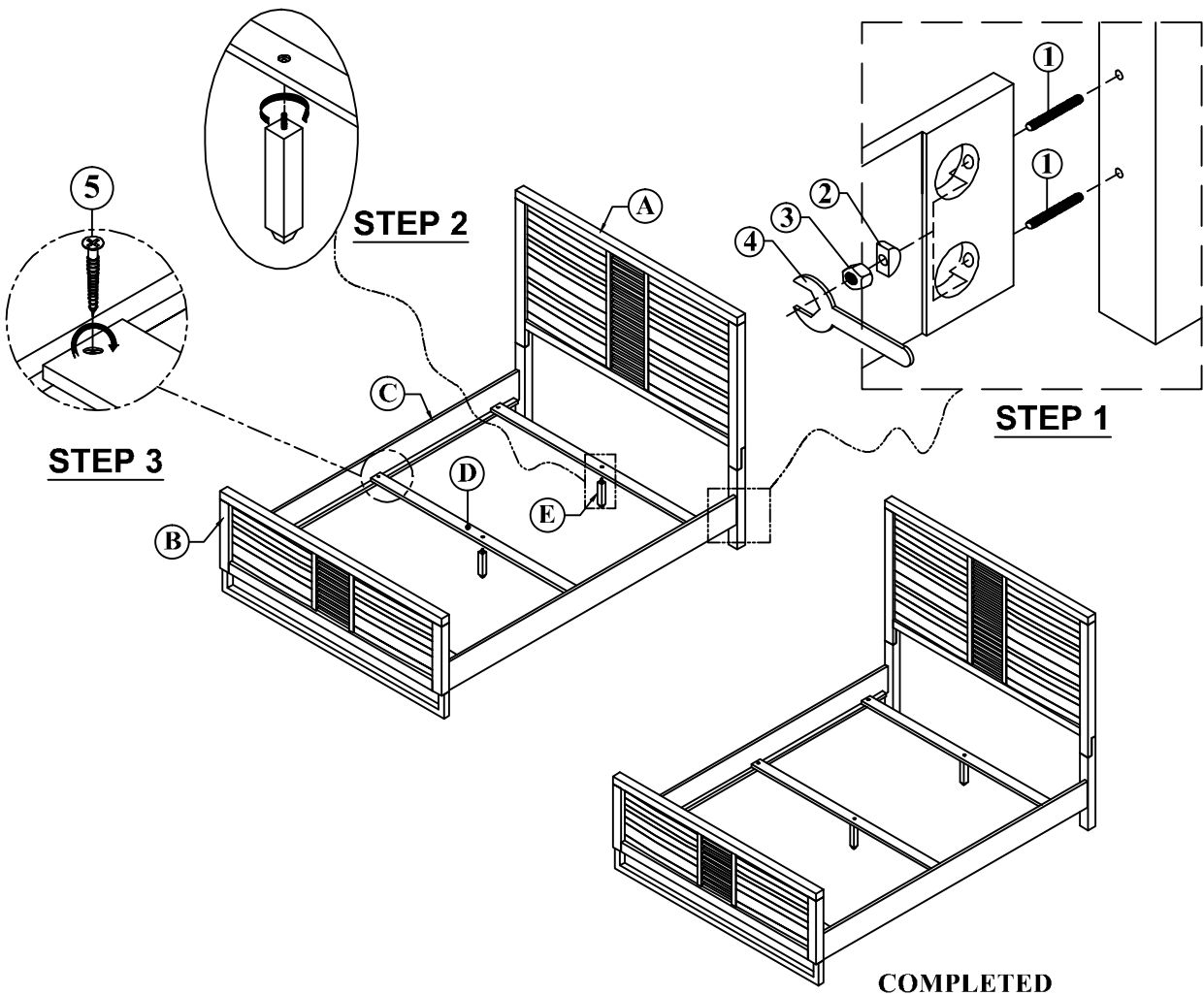



Thank you for purchasing this quality product. Be sure to check all packing material carefully for small parts which may have come loose inside the carton during shipment. Separate, identify and count all parts and metal hardware. Compare with parts list to be sure all parts are present. If any part(s) are missing or damaged, please contact your local furniture dealer. For efficient and speedy service, please indicate the model number and code letter of part(s) needed.

***** Do not fully tighten screws until fully assembled *****

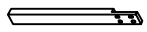
PARTS LIST

NO	DESCRIPTION	SKETCH	QTY
A	HEADBOARD		1 Pc
B	LEGS		2 Pcs

HARDWARE LIST

NO	DESCRIPTION	SKETCH	QTY
1	BOLT		8 Pcs
2	FLAT WASHER		8 Pcs
3	ALLEN WRENCH		1 Pc

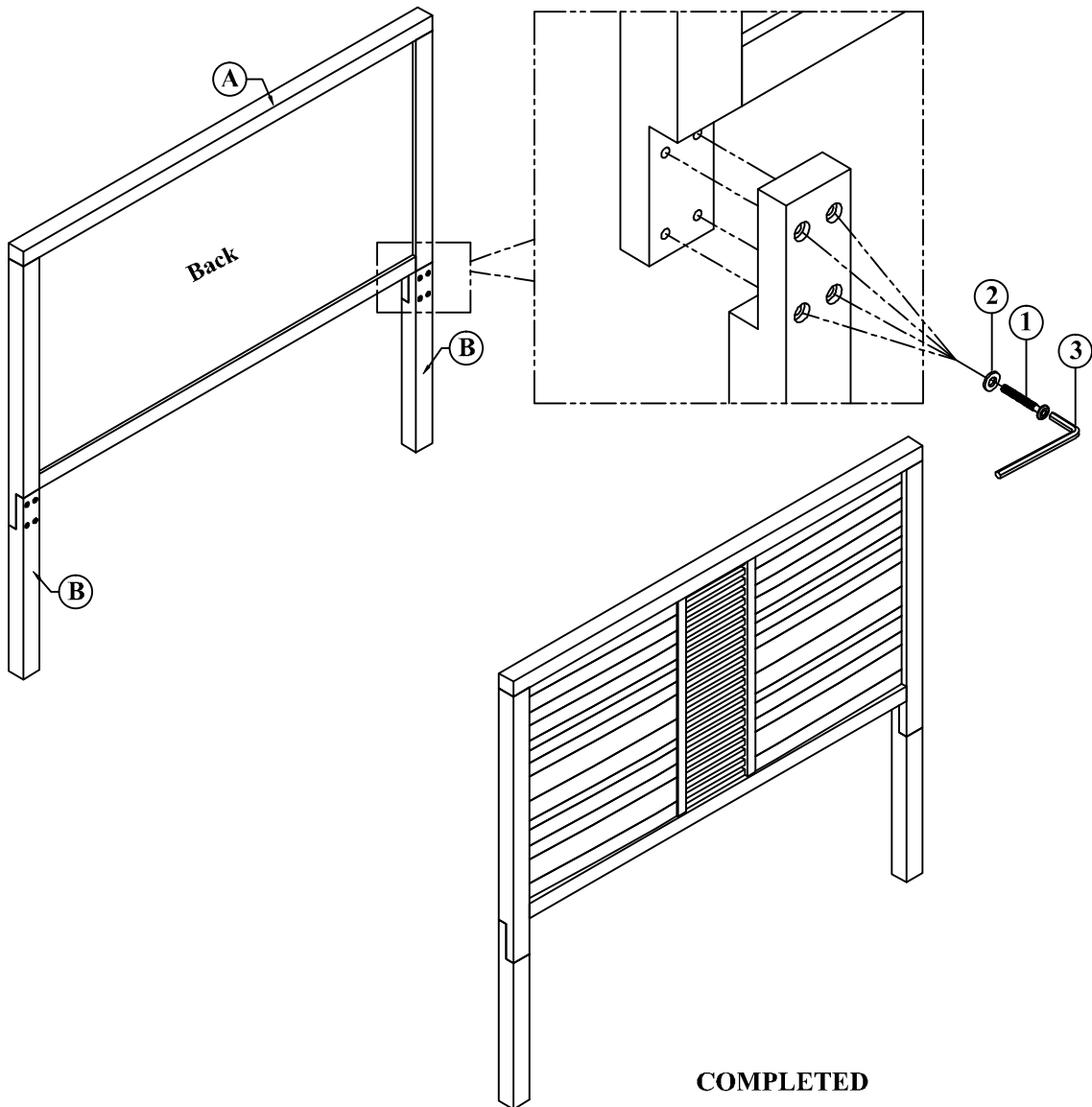

COMPLETED