

ASSEMBLY INSTRUCTIONS

bed - full

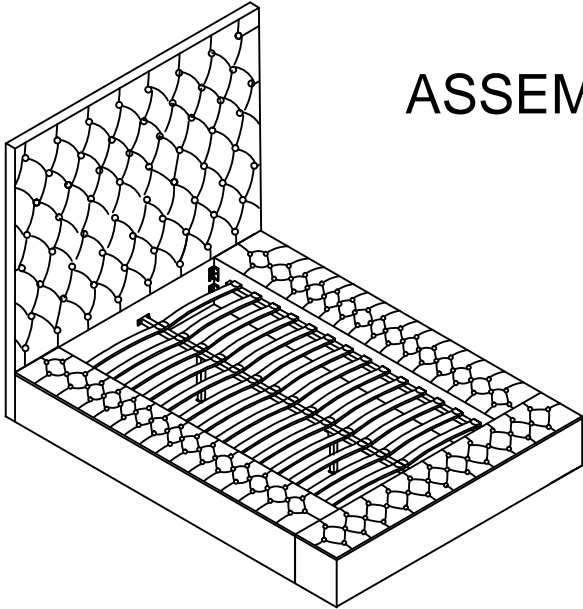

+ Do Not Use Power Tools



+ Suggested Adults

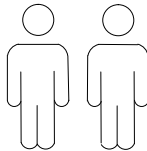

NOTE:

- 1 Read instructions cover to cover.
- 2 Save all packaging until assembly is completed.

1 IMPORTANT SAFETY INFORMATION

Do not assemble the product if any of the following parts arrived damaged:

- Part # ③ -Side Rails
- Part # ⑤ -Center Support Bar
- Part # ⑥ -Support Legs
- Part # ⑦ -Slats

2 IMPORTANT ASSEMBLY INFORMATION

Assembly Step ③ Ensure the side rail bracket is fully hooked onto bolt **A** loosely threaded with both washers on the **OUTSIDE** of the bracket first, then proceed to fully tightening all 4 corners.

Assembly Step ⑦ When installing slats, ensure that the curve is facing upwards. (↖) (↘)
*Slats come packed in the bottom of headboard carton.

+ Parts Included

① Head Board (1pc)

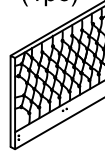

② Foot Board (1pc)

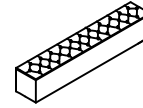

③ Side Rails (2pcs)

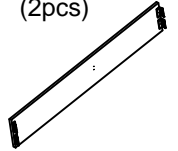

④ Side Rails (2pcs)

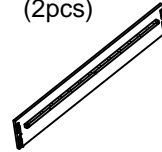

⑤ Center Support Bar (1pc)



⑥ Support Legs (2pcs)

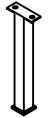

⑦ Slats (28pcs)



⑧ Single Plastic cap (28pcs)



⑨ Double Plastic cap (14pcs)



*Slats come packed in the bottom of headboard carton.

⑩ -Bracket (6pcs)



⑪ -Middle support board (1pc)



⑫ -Middle support board (2pcs)



*Middle support Board comes packed in the footboard carton 2/3

*Middle support Board comes packed in the footboard carton 2/3

⑬ - Side bottom board (2pcs)

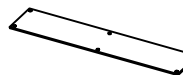

* 1 of 2 side bottom boards comes packed in side rail carton 3/3. 2/2 packed in footboard carton 2/3

⑭ - Side top board (2pcs)

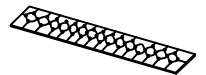

+ Hardware Included

A Bolt M8*30mm (36pcs)



B Bolt M8*20mm 26pcs



C Nut M8*13mm (4pcs)



D Spring Washer (32pcs)



E Flat Washer $\phi 20$ (66pcs)



F M8 Allen Key (1pc)



G Spanner (1pc)



H Bolt M8*25mm (4pcs)



ASSEMBLY INSTRUCTIONS

bed - full

