

---

**ASSEMBLY AND CARE  
INSTRUCTION**  
Commodity Shelf

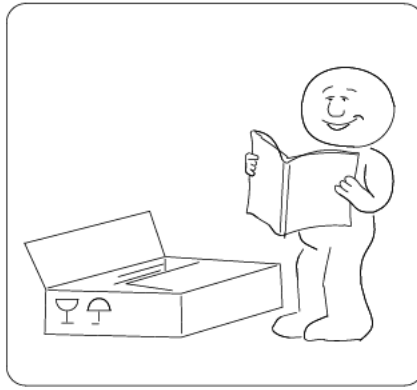
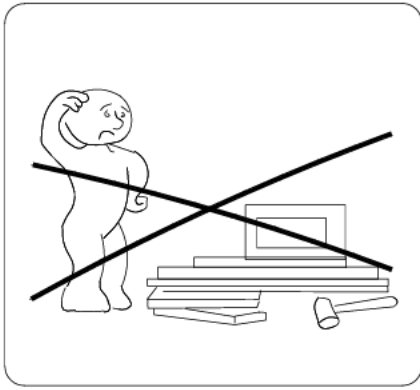

**! WARNING !**

1. PLEASE READ ALL INSTRUCTIONS CAREFULLY BEFORE STARTING ASSEMBLY.
2. DO NOT LET ANY SHARP OBJECTS TOUCH OR RUB THE SURFACE OF THE PRODUCT.
3. WHEN ASSEMBLING, DO NOT LET CHILDREN PLAY AROUND THE WORKING AREA.
4. PLEASE CONFIRM ALL PARTS ARE CORRECT BEFORE STARTING THE ASSEMBLY PROCESS.
5. DO NOT TIGHTEN ALL BOLTS AND SCREWS COMPLETELY UNTIL THE ENTIRE UNIT HAS BEEN ASSEMBLED AND SET UP.

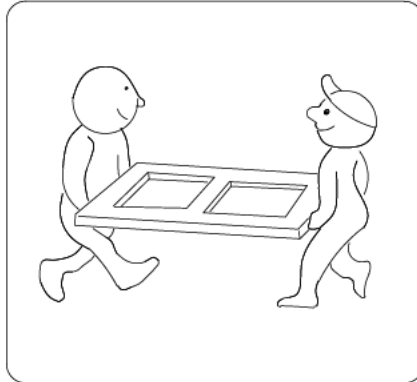
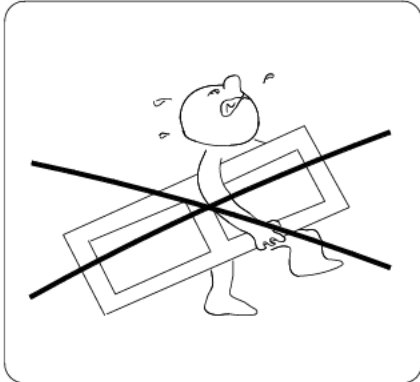
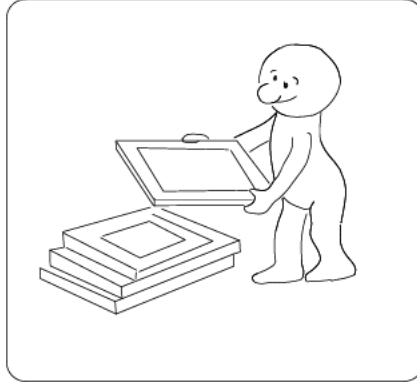
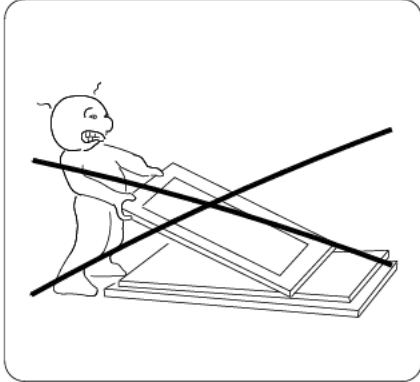

**ADVISE**

1. DO NOT SIT OR STAND ON THIS PRODUCT. IT IS INTENDED FOR PETS ONLY.
2. THIS PRODUCT SHOULD BE ASSEMBLED BY AN ADULT.
3. PLEASE PUT THE PRODUCT ON A SMOOTH SURFACE AFTER YOU ASSEMBLED IT.
4. PLACE ALL PARTS ON A CLEAN AND SMOOTH SURFACE SUCH AS A RUG OR CARPET TO AVOID THE PARTS FROM BEING SCRATCHED.
5. THE SCREW OF HINGE ON THE DOOR ALSO CAN BE ADJUSTABLE, TO MAKE IT EVEN THEN TIGHTEN ALL SCREWS.

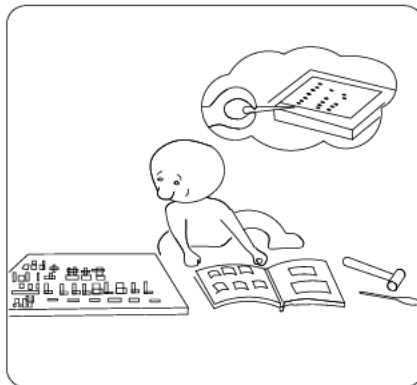
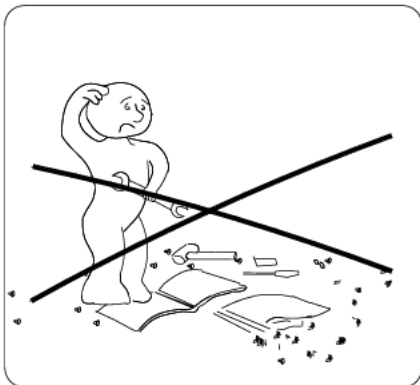

**TOOL NEEDED**



**SCREWDRIVER REQUIRED  
- NOT INCLUDED**

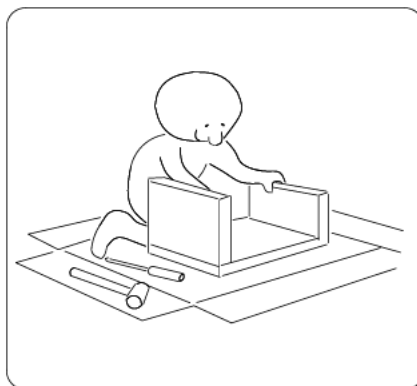
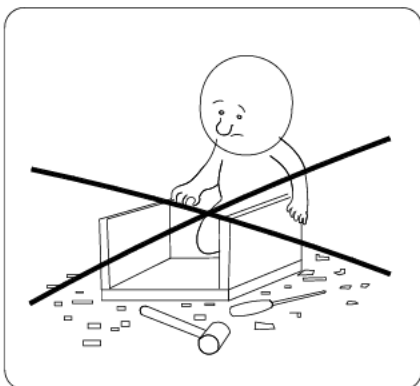

**PARTS**

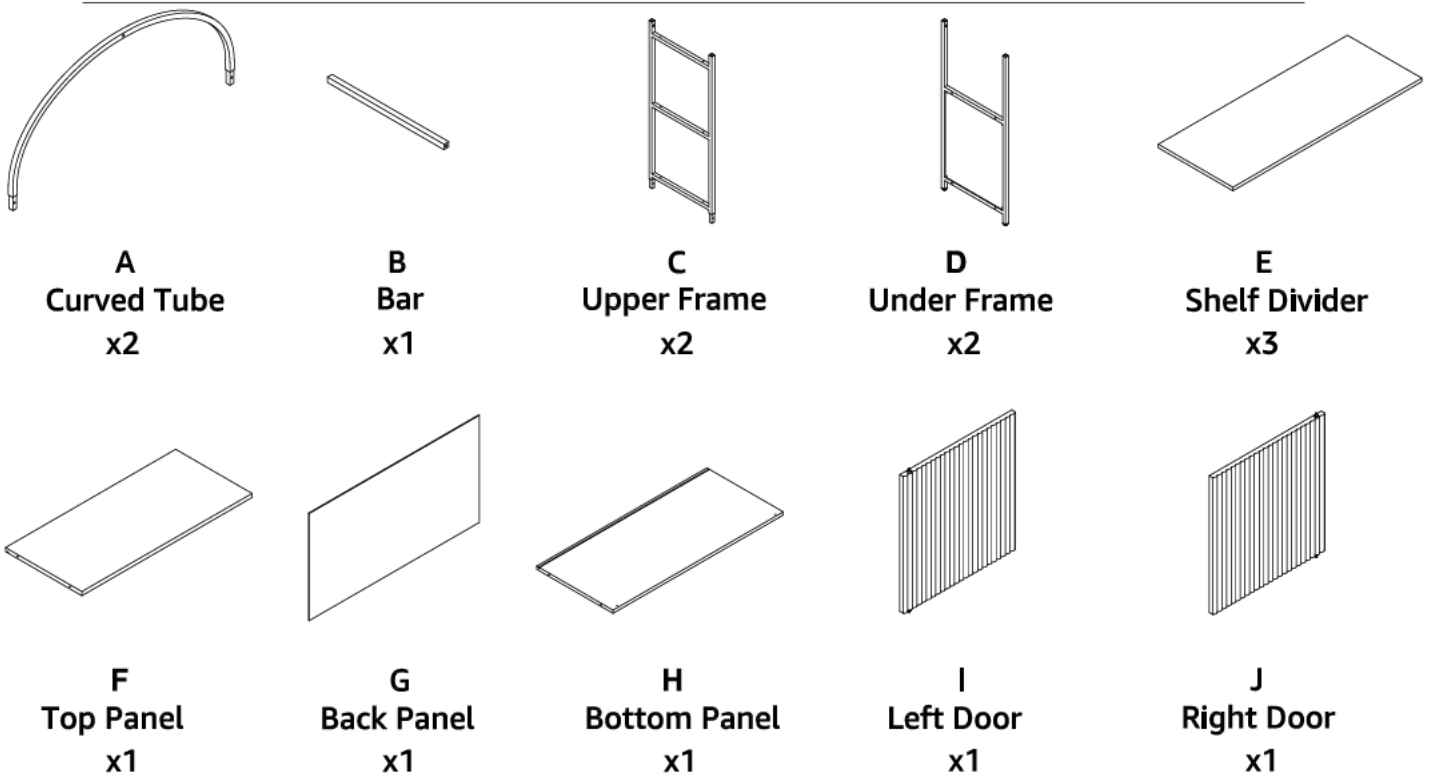
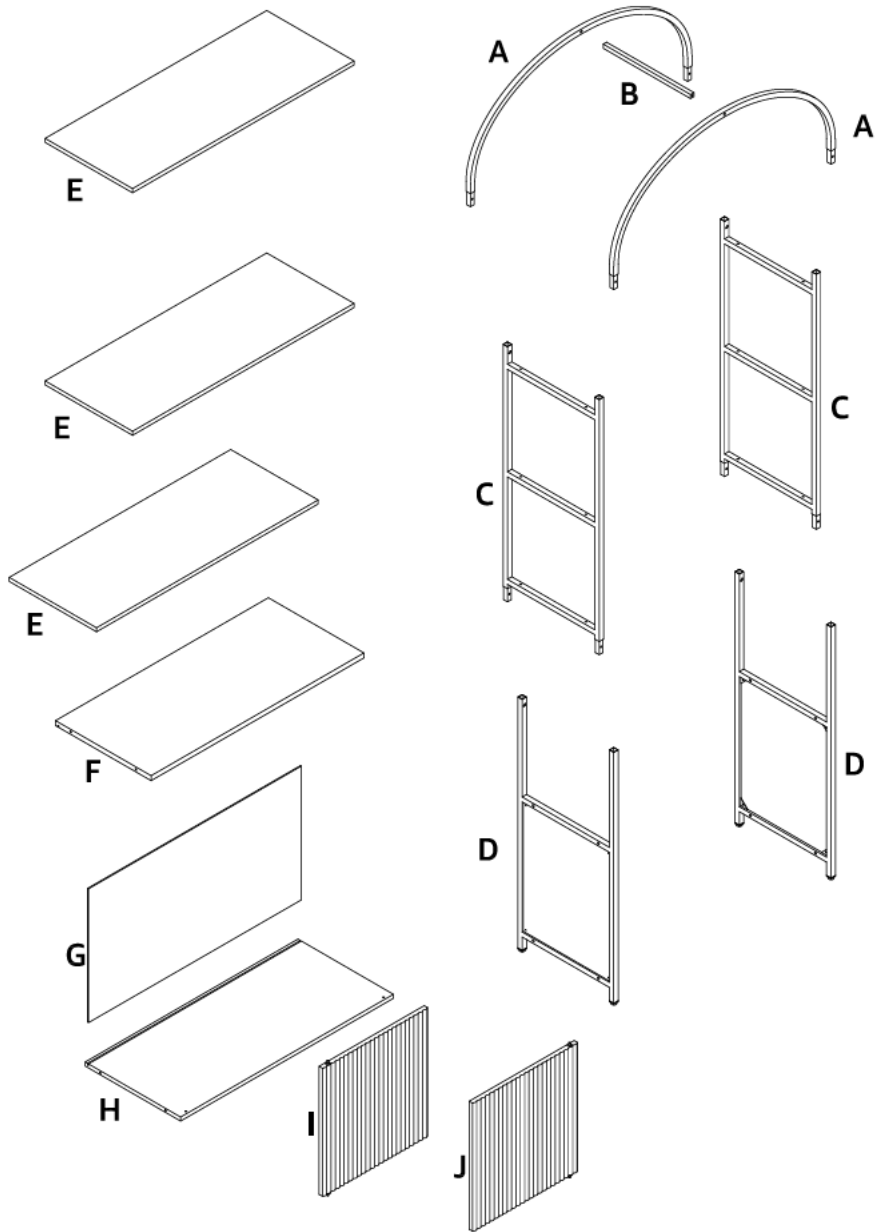

## HARDWARE

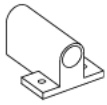

1

x 2 pcs



2

x 4 pcs



3

x 8 pcs



4

x 8 pcs



5

x 12 pcs



6

x 4 pcs



7

x 4 pcs



8

x 2 pcs



9

x 2 pcs

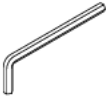

10

x 1 pc



11

x 4 pcs



12

x 4 pcs



13

x 2 pcs

## ASSEMBLY INSTRUCTIONS

1

Tighten Magnet 1 to Top Panel F with screw 2 by screwdriver.

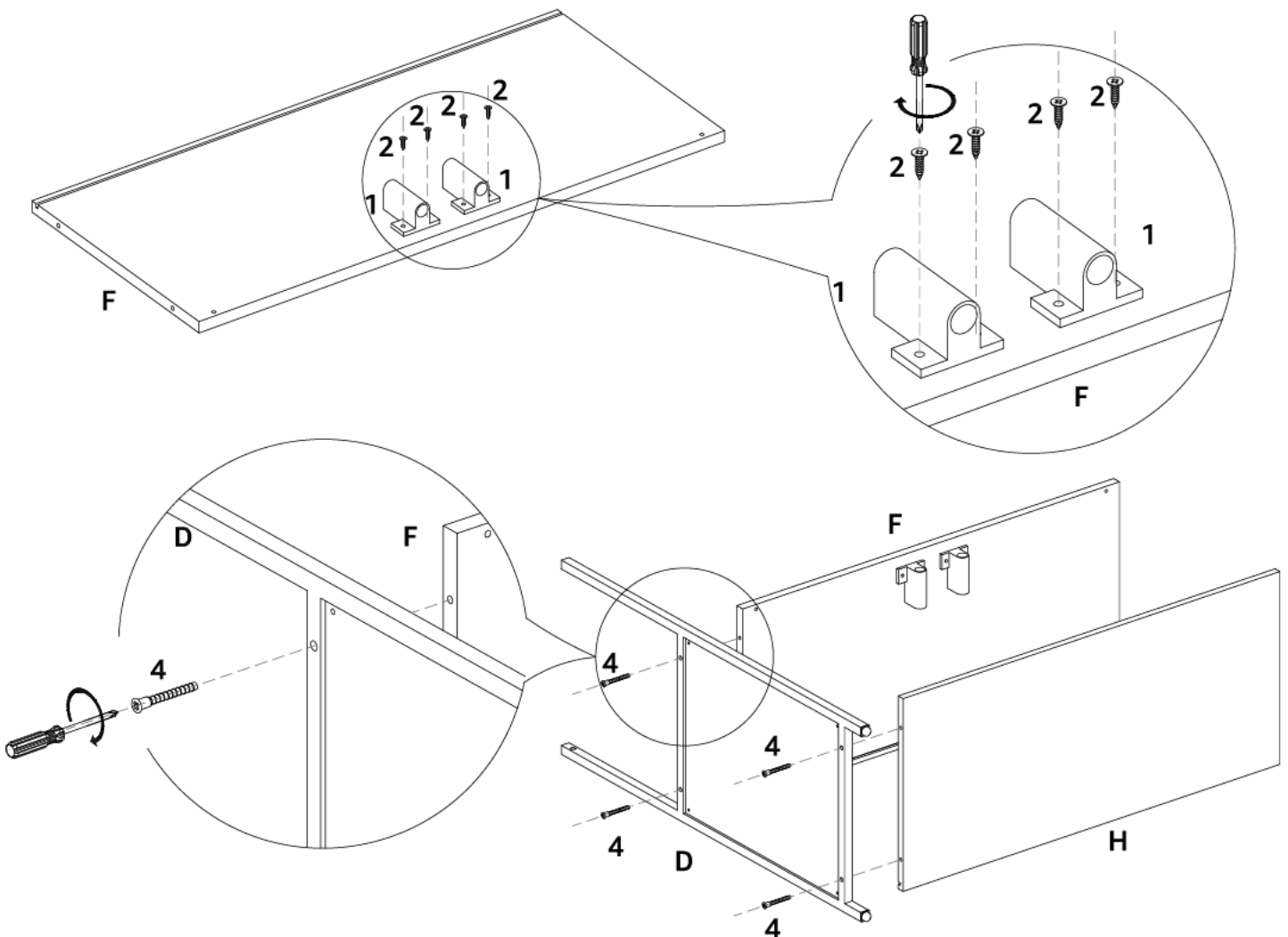
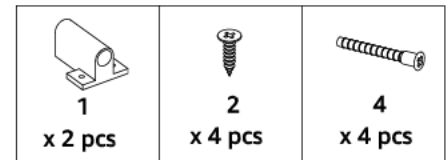

Connect left-side Under Frame D to Top panel F. Bottom panel H with screw 4 tightened.

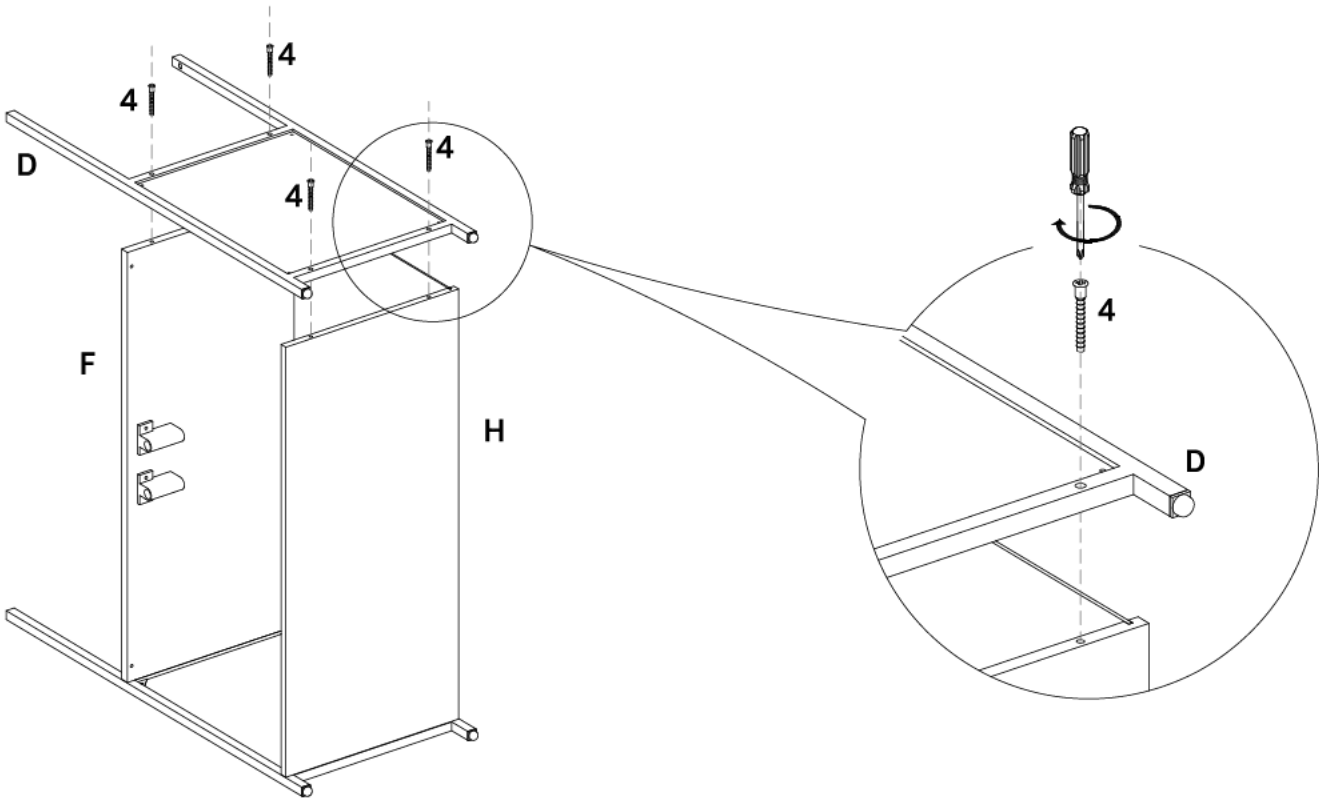
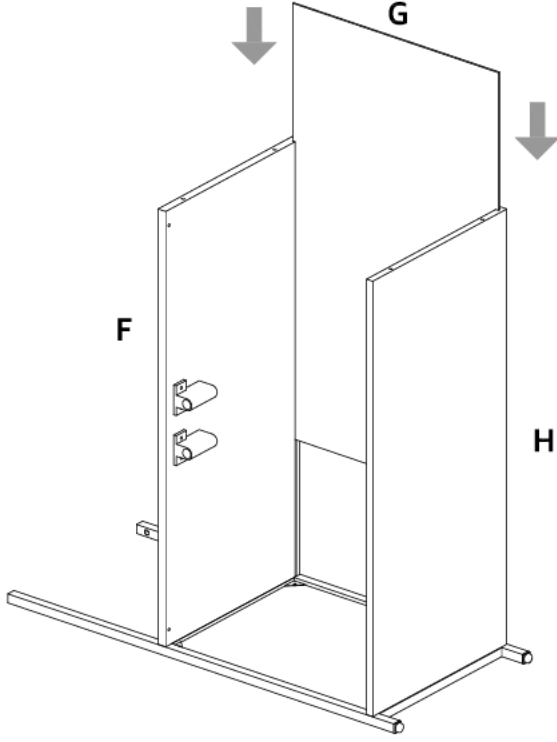
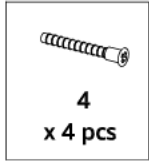

**2** Insert Back Panel G along the track of Panel F. H.  
Connect right-side Under Frame D to Top panel F, Bottom panel H with screw 4 tightened.



**3** Insert Upper Frame C into Under Frame D with screw 3 tightened by Allen wrench. Insert two Curved Tubes A into Upper Frame C with screw 3 tightened. Connect Bar B to Curved Tube A with screw 13 tightened.



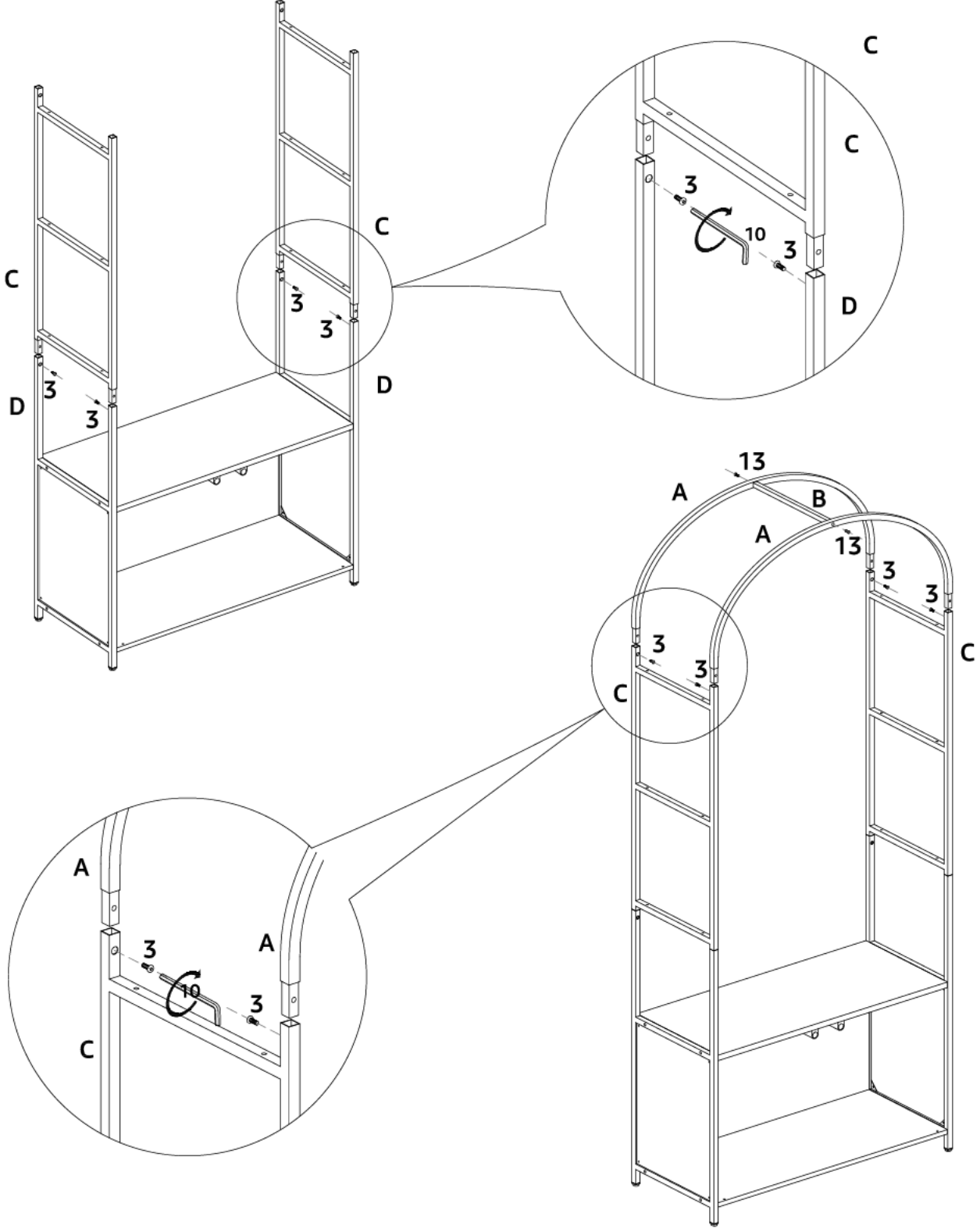

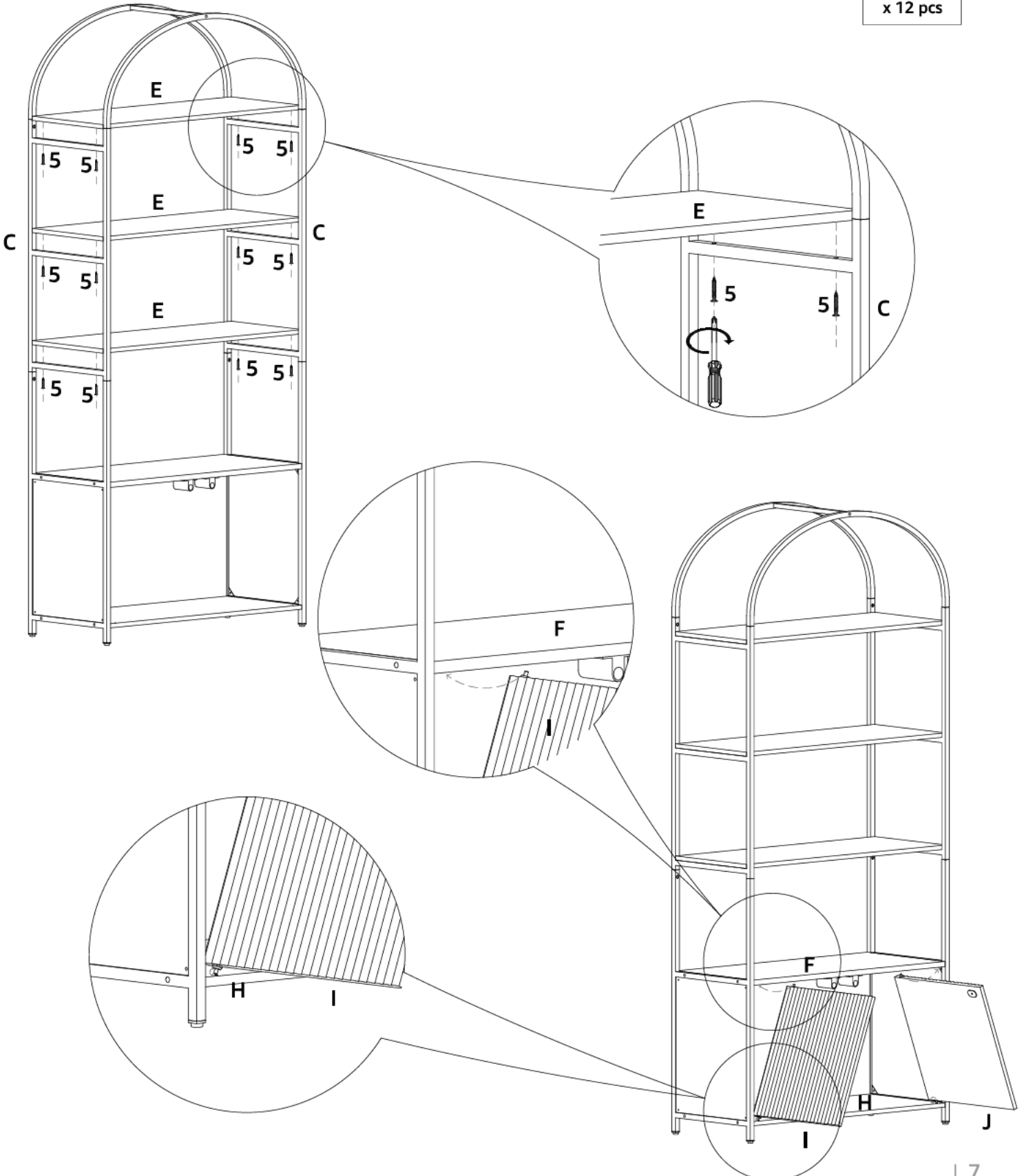
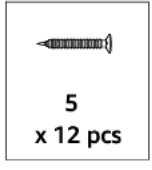

		
3	13	10
x 8 pcs	x 2 pcs	x 1 pc



**4** Put Shelf Divider E to Commodity Shelf and tighten it with screw 5. Install the Left & Right Door on shelf by pressing the button on the door.



**5** Tighten Rear Panel Hook 11 to Back Panel G with screw 12.  
 For safety use, you can secure the shelf where you want it to be on the wall by tilting prevention device.

					
<b>11</b> x 4 pcs	<b>12</b> x 4 pcs	<b>6</b> x 4 pcs	<b>7</b> x 4 pcs	<b>8</b> x 2 pcs	<b>9</b> x 2 pcs

