

Assembly Instruction

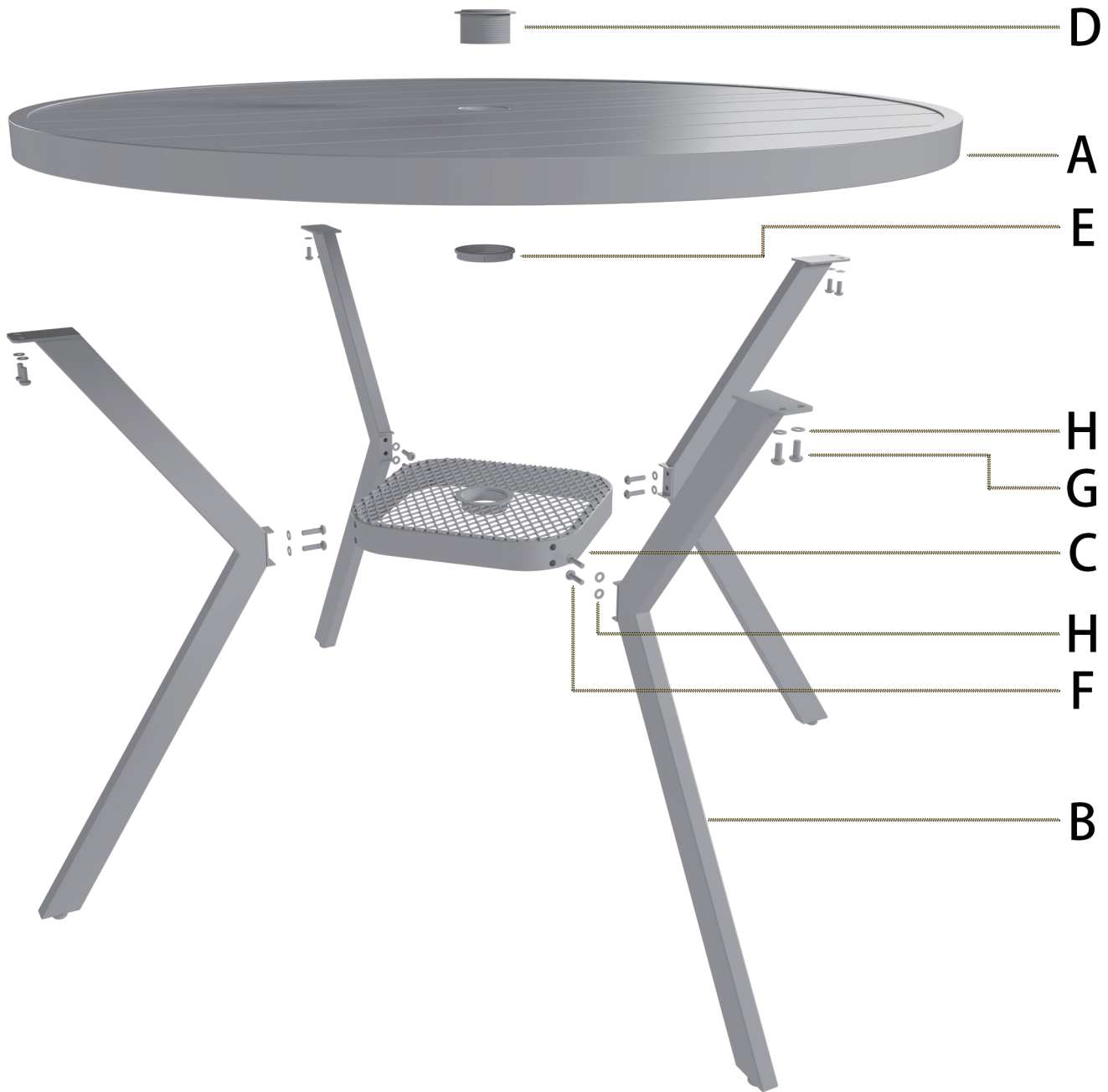

Exploded Drawing



Cleaning and Maintenance

1. Clean the furniture with damp cloth, rinse thoroughly. Dry frame parts completely. Do not use bleach, acid or other solvents on the wicker or metal parts.
2. We recommend the use of furniture covers to protect the product when not in use.
3. Inspect and tighten all SCREW on a regular basis to ensure proper performance and safety.
4. In order to prolong the life and beauty of your Item, we recommend storing it in a dry and protected area during off season periods.

Parts List

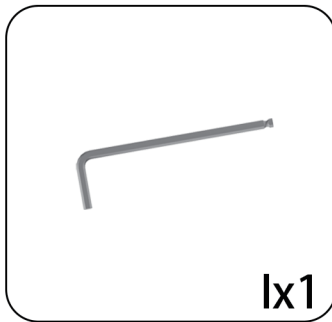
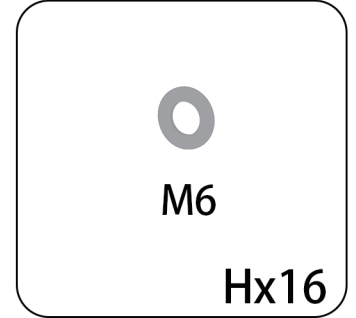
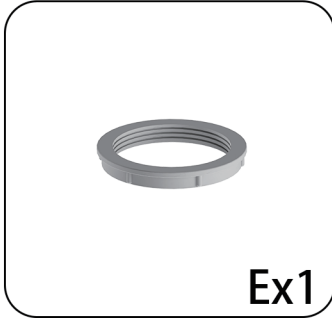
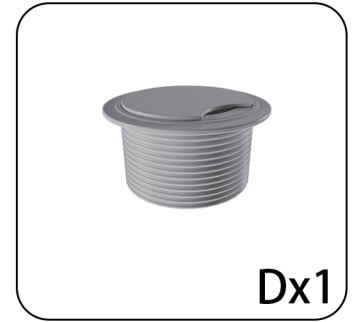
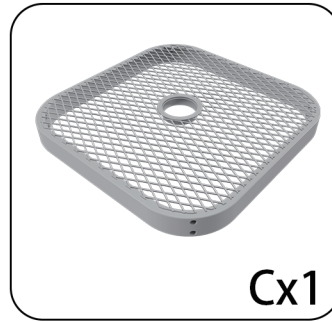
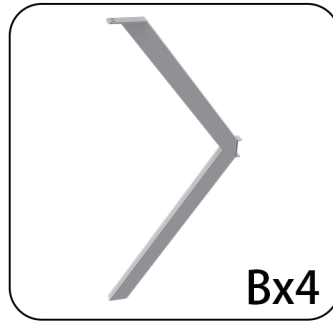
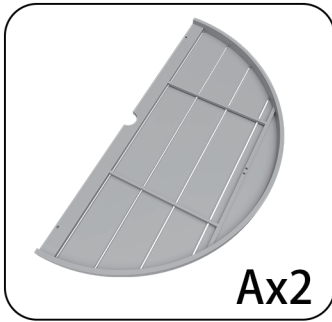

Please ensure you follow these instructions

It is incorrect to completely tighten the screws at the very beginning during the installation process. Just make sure that all the components can be fixed in place. Please wait until all the screws are installed before tightening them one by one.

1

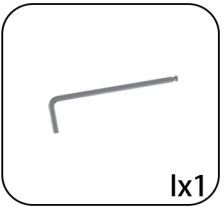
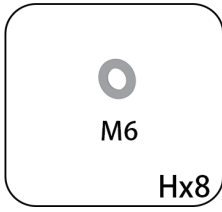
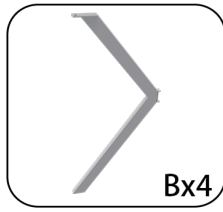
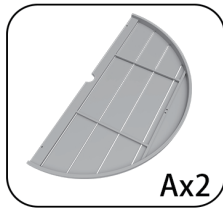

Install parts A and B with screws G and gaskets H

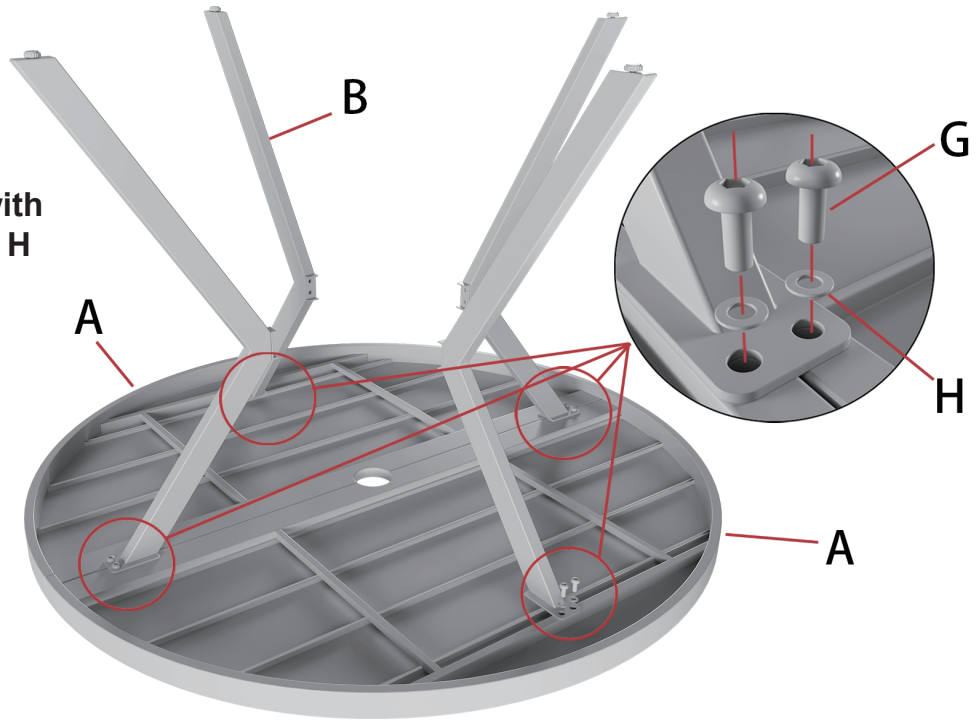

2

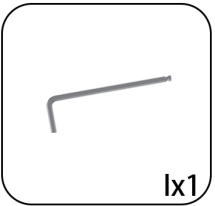
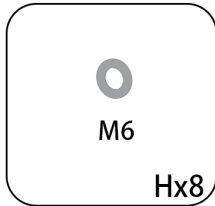
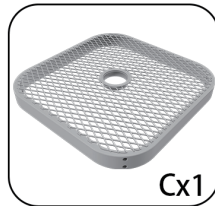

Install components C and B with screws F and washers H. If the above letters are not marked, please refer to the previous step.

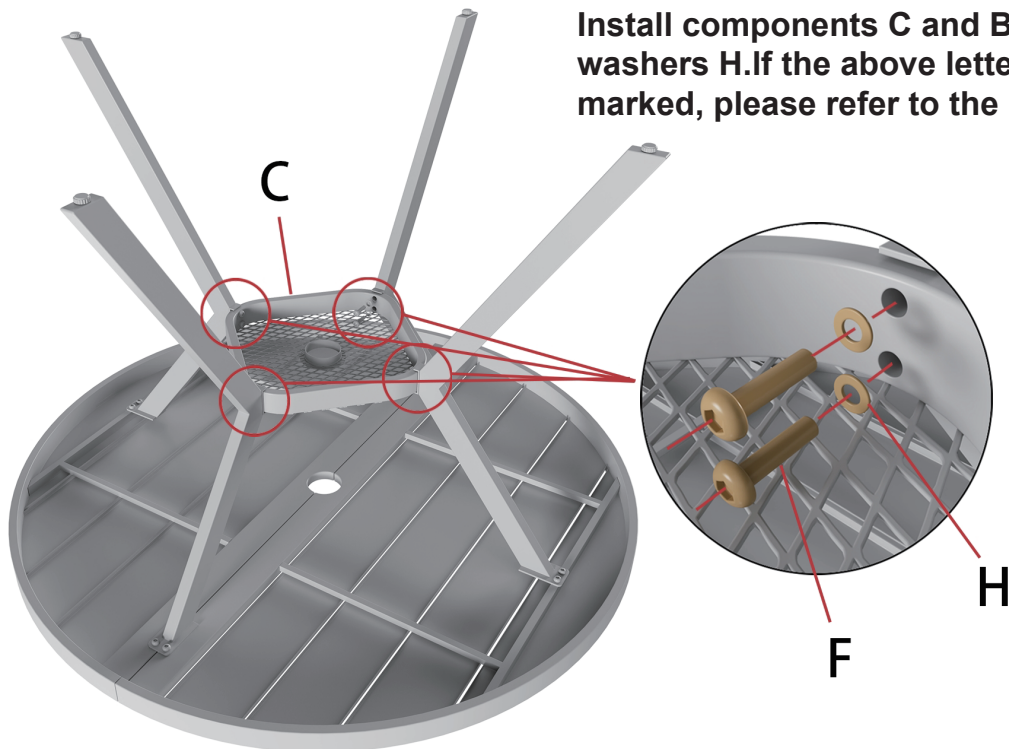

3

3

First, lower D from the top into the hole,
and then tighten E

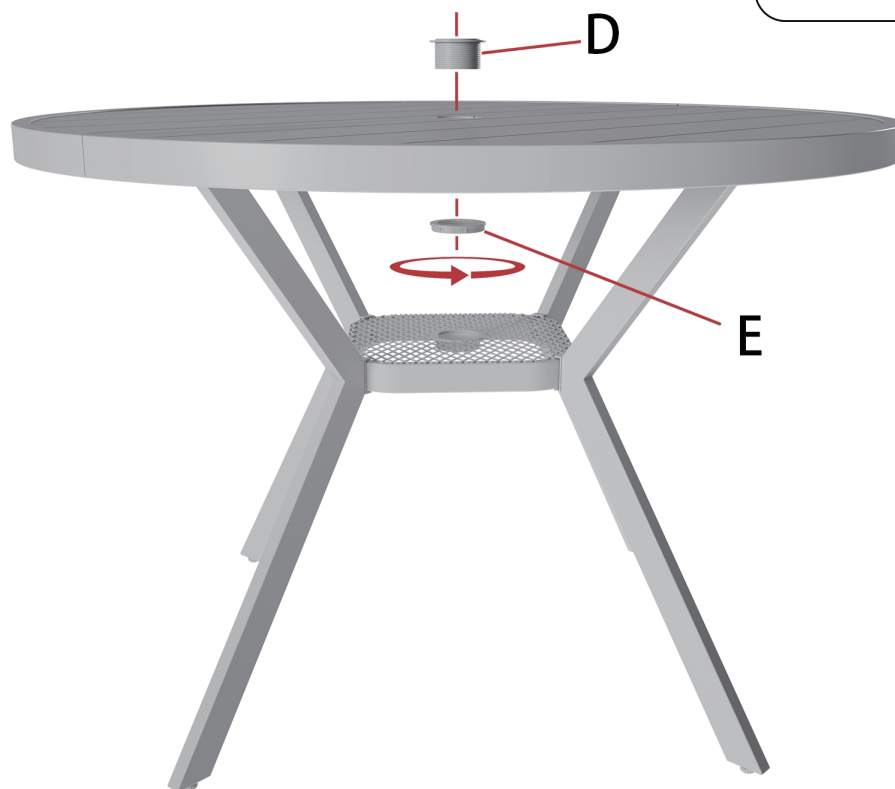
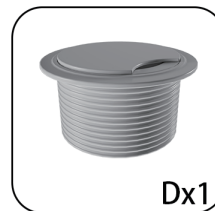

4



AFTER-SALE SERVICE

If you have any suggestions for our products or find that the products have quality problems, please contact us first, our after-sales team will reply you within 24 hours, and we will do our best to give you solutions until you are satisfied.

Guaranteed Customer Service

Your shopping experience is very important to us!
Feel unsatisfied? **Contact us!**
Have any questions? **Contact us!**

Wanna share your experience with our products?
Share your pictures with us.

Any suggestions? **Contact us!**
We gotcha back!