

USER'S MANUAL

DINING CHAIR

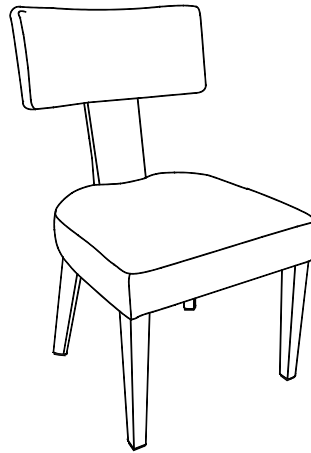

Guide of Manual

- ★ Thanks for your choice. **We will do our best to provide customer service for everyone.**
- ★ Please check to make sure all parts are included as stated when you unpack. If there are parts missing or wrong, please contact us, **we will expeditiously provide reissue accessories, compensation or other services.**
- ★ Instruction should be read carefully. But the manual may not cover every detail of all possible situations and steps. **Please contact us if further information and help are needed. We will respond in a timely manner.**
- ★ Please be patient that the other items are on the way if you buy more than one product.

Warning

- It's kindly advised to assemble this product on a carpeted floor to protect it from being scratched.
- Small parts are included. Please keep the product away from children while assembling. Do not let children play or jump on the product. Do not stand on the item or use as a step ladder.
- Please pay attention to the sharp corners during assembly. We recommend the use of gloves to prevent the undesired injury.
- Prior to use, please check to see if there's any loosening screw or part. Make sure that each screw and part is correctly installed and securely fastened.
- Usually it's unnecessary to use electric drill. Please at a low gear if you need.

Care and Maintenance

- Use a soft, clean cloth that will not scratch the surface when dusting.
- There's no need to use furniture polish. If you need, test it first in an inconspicuous area. Using solvents of any kind on your furniture may damage the finish. Never use water to clean your furniture as it may cause damage to the finish.
- Liquid spills should be removed immediately. Gently blot the spill with a soft clean cloth to avoid rubbing.

Further Advice About The Furniture Care



- It is best to keep your furniture in a climate-controlled environment.
- We recommend to keep furniture from sunlight exposure to avoid possible surface damage.
- Following these important and helpful tips will help retain your furniture's performance even when it ages.
- Periodically (every 90 days) make sure the screws are fully tightened.

**⚠ MAX WEIGHT CAPACITY:350LBS
DO NOT STAND ON THE ITEM**



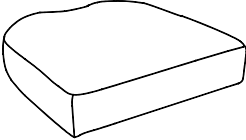
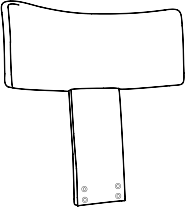

Parts List & Assembly Instruction

1. Make sure all parts are in the package.
2. "+" in below list indicates that additional pieces are replacement parts.
3. Do not fully tighten anything until all screws, nuts, washers and bolts are in place.

Parts List

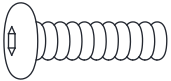
<p>Ax1pc Seat</p> 	<p>Bx1pc Backrest</p> 	<p>Cx2pcs Front legs</p> 	<p>Dx2pcs Back legs</p> 
---	---	--	---

Hardware List

<p>Ex12+1pcs Screws</p>  <p>M8*45mm</p>	<p>Fx12+1pcs Flat Washers</p> 	<p>Gx12+1pcs Spring Lock Washers</p> 	<p>Hx1pc Allen Wrench</p> 
--	---	---	---

<p>Ix4+2pcs Felt Pads</p> 

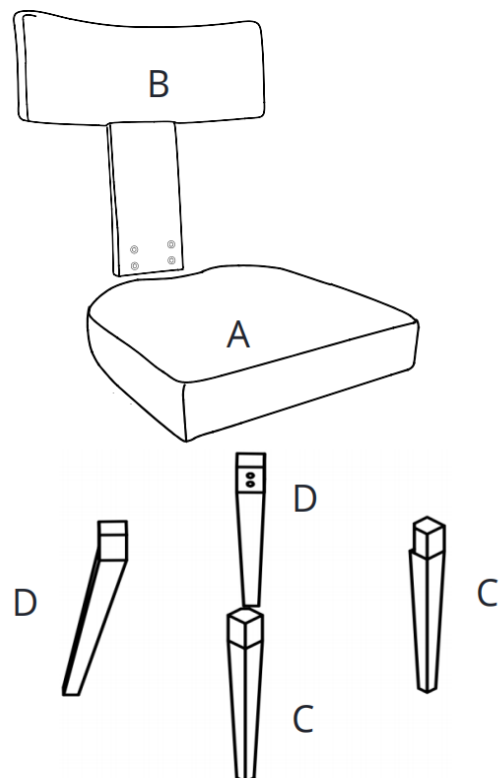

Step1

Open the zipper and take out the components placed in A.

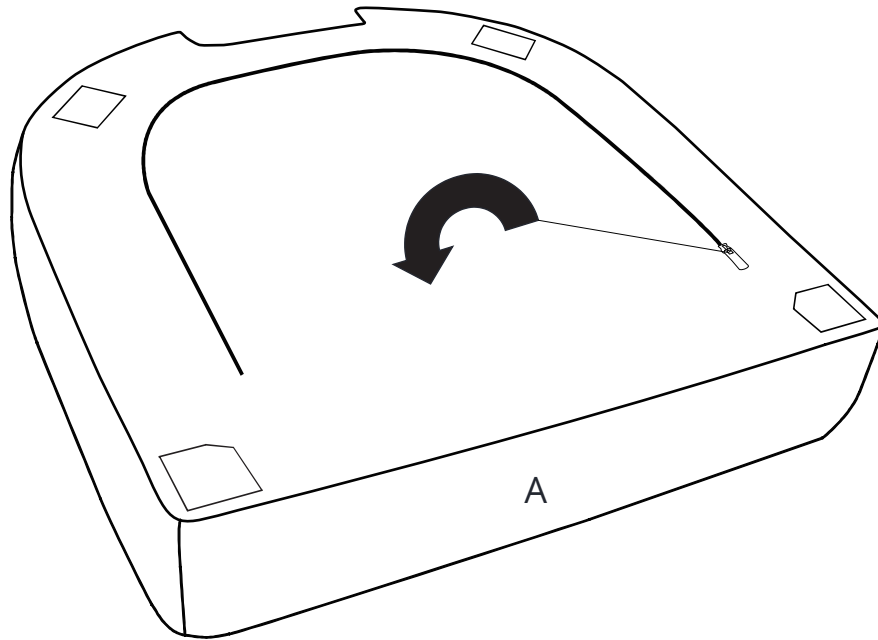

Step2



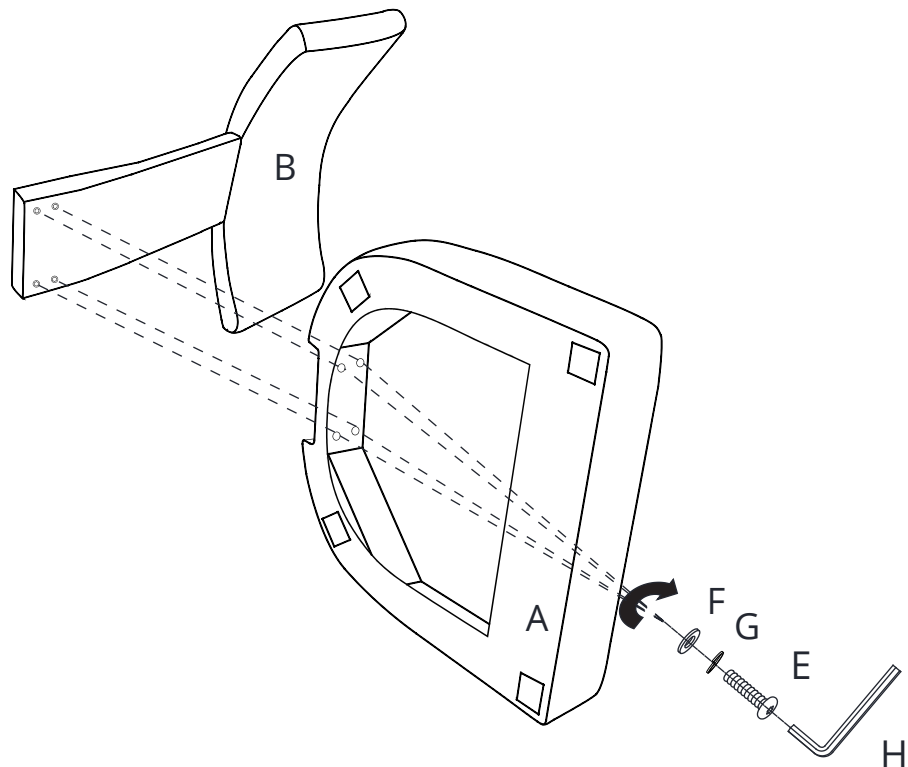
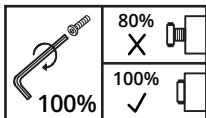

Please completely tighten the backrest B with screw E in this step.



E		x4
F		x4
G		x4
H		x1



Step3

Insert the front leg C and back leg D into the corresponding holes, and then completely tighten them with screw E in this step. Peel off the felt pad I and stick one to each leg.

E		x8
F		x8
G		x8
H		x1
I		x4

	80%	
	X	
100%	✓	

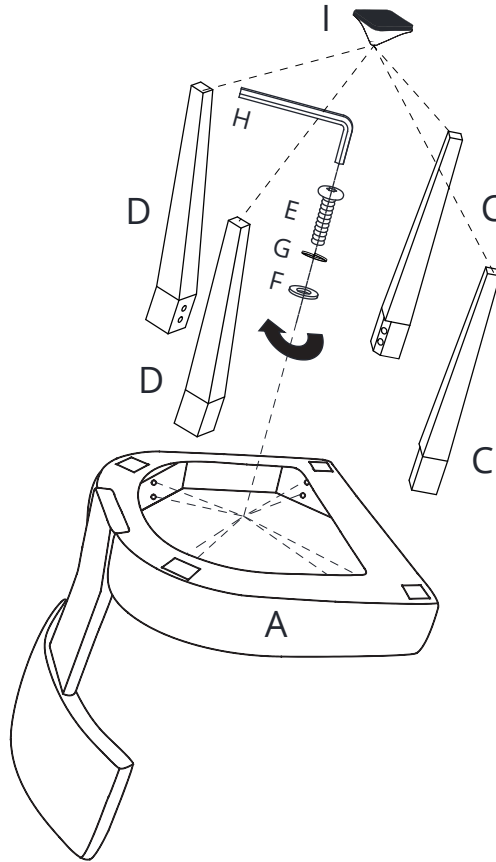

FINISHED

