

# Installation Manual of Trim Kit

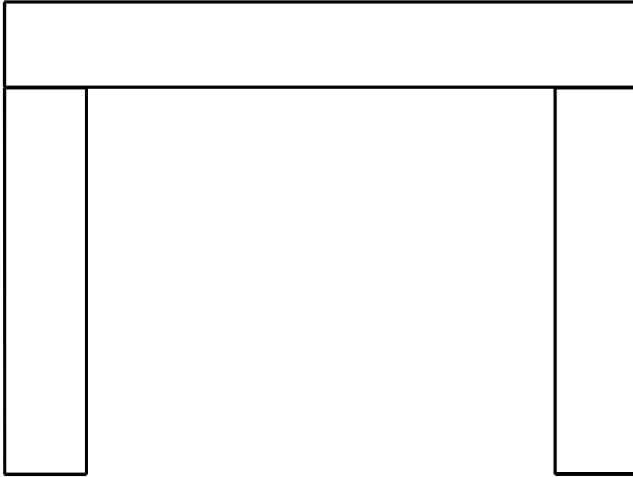

**SAVE THESE INSTRUCTIONS FOR FUTURE REFERENCE.**

# 1. PRODUCT DIMENSIONS

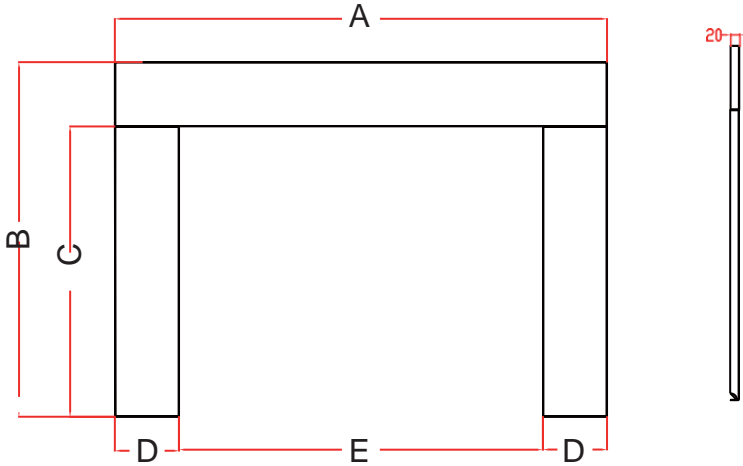

Trim Kit for	Unit	A	B	C	D	E
	mm	1002	750	602	147.5	707
	inches	39.4	29.5	23.7	5.8	27.8
	mm	1065	750	602	147.5	770
	inches	41.9	29.5	23.7	5.8	30.3
	mm	1132	816	668	147.5	837
	inches	44.5	32.1	26.3	5.8	33.0
	mm	1132	653	505	147.5	837
	inches	44.5	25.7	19.9	5.8	33.0

## 2. PART LIST

A.

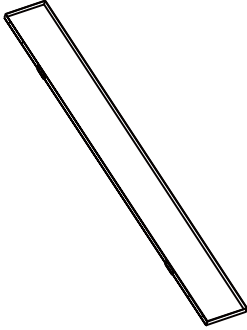

Top Panel(1PC)

B.

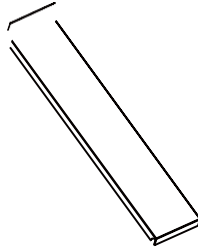

Right Panel(1PC)

C.

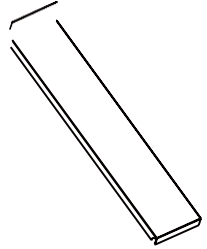

Left Panel(1PC)

D.

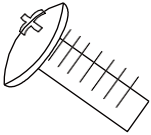

Screw M4\*8(4Pcs)

E.



Spring Washer(4Pcs)

F.

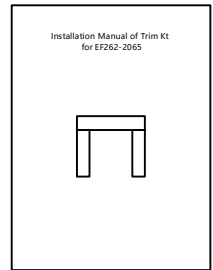

Manual(1PC)

### 3. INSTALLATION

#### Tools Required

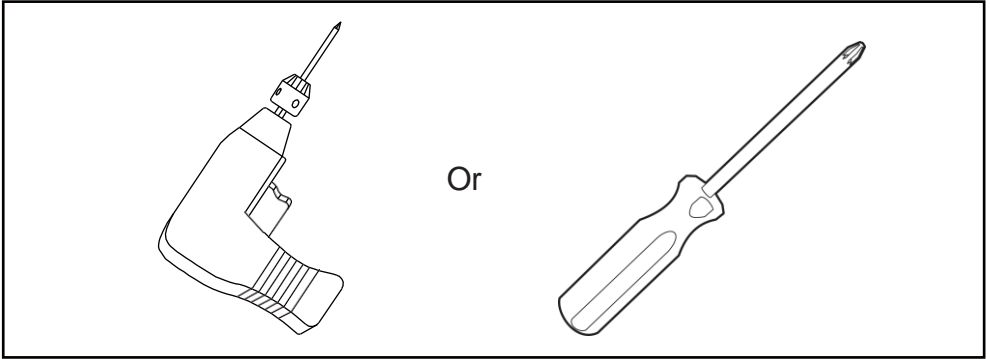

#### STEP 1

Use four screws to secure the top panel to the left and right side panels.

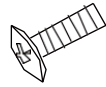
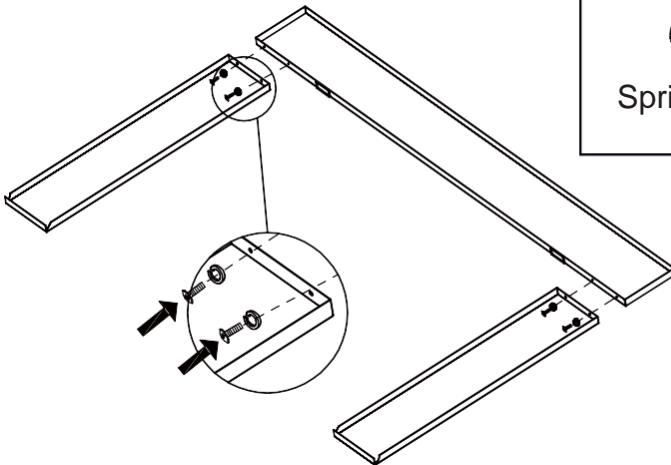

M4\*8 X 4 pcs



Spring Washer  
(4pcs)

## STEP 2

Load the assembled Trim from the top and attach the magnet to the top of the Fireplace.

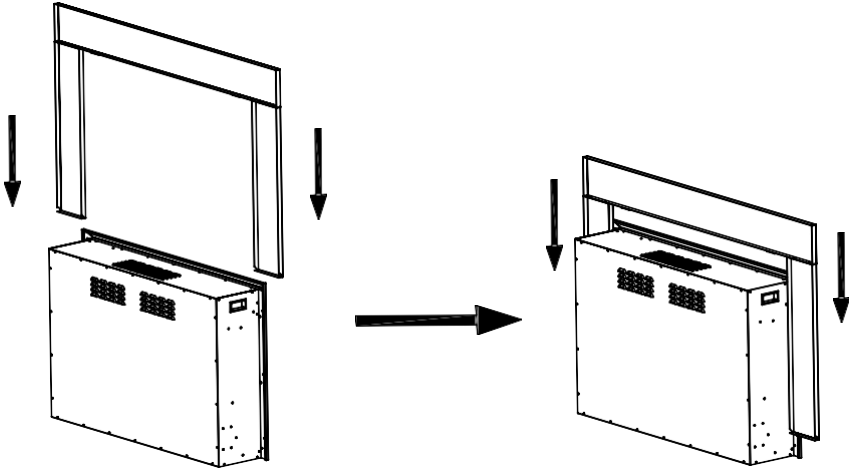

## Finish Installation

