

## Features

- High-arch nondiverter spout with slip-fit connection
- Requires K-411-K spout shank (sold separately) if not used with K-300-K/-, K-300-KR, or K-301-K high-flow ceramic disc valves

## Material

- Brass
- KOHLER finishes resist corrosion and tarnishing

## Installation

- Deck-mount

## Required Products/Accessories

K-411-K Bath Filler Spout Shank

or

K-300-K 1/2" ceramic high-flow valve system

or

K-300-KR 1/2" ceramic high-flow valve

or

K-301-K 3/4" high-flow bath valve

## Recommended Products/Accessories

K-14375 24" Double Towel Bar  
K-14377 Pivoting toilet paper holder  
K-14435 18" Towel Bar  
K-14436 24" Towel Bar  
K-14441 Towel Ring  
K-14443 Robe Hook  
K-14444 Vertical toilet paper holder



**ADA** **CSA B651** **OBC**

## Codes/Standards









ASME A112.18.1/CSA B125.1  
ADA  
ICC/ANSI A117.1  
CSA B651  
OBC

## KOHLER® Faucet Lifetime Limited Warranty

See website for detailed warranty information.

## Available Colors/Finishes

*Color tiles intended for reference only.*

Color	Code	Description
	CP	Polished Chrome
	SN	Vibrant® Polished Nickel
	AF	Vibrant® French Gold
	BN	Vibrant® Brushed Nickel
	BV	Vibrant® Brushed Bronze
	BL	Matte Black
	2MB	Vibrant® Brushed Moderne Brass
	BGP	Brushed Graphite
	TT	Vibrant Titanium

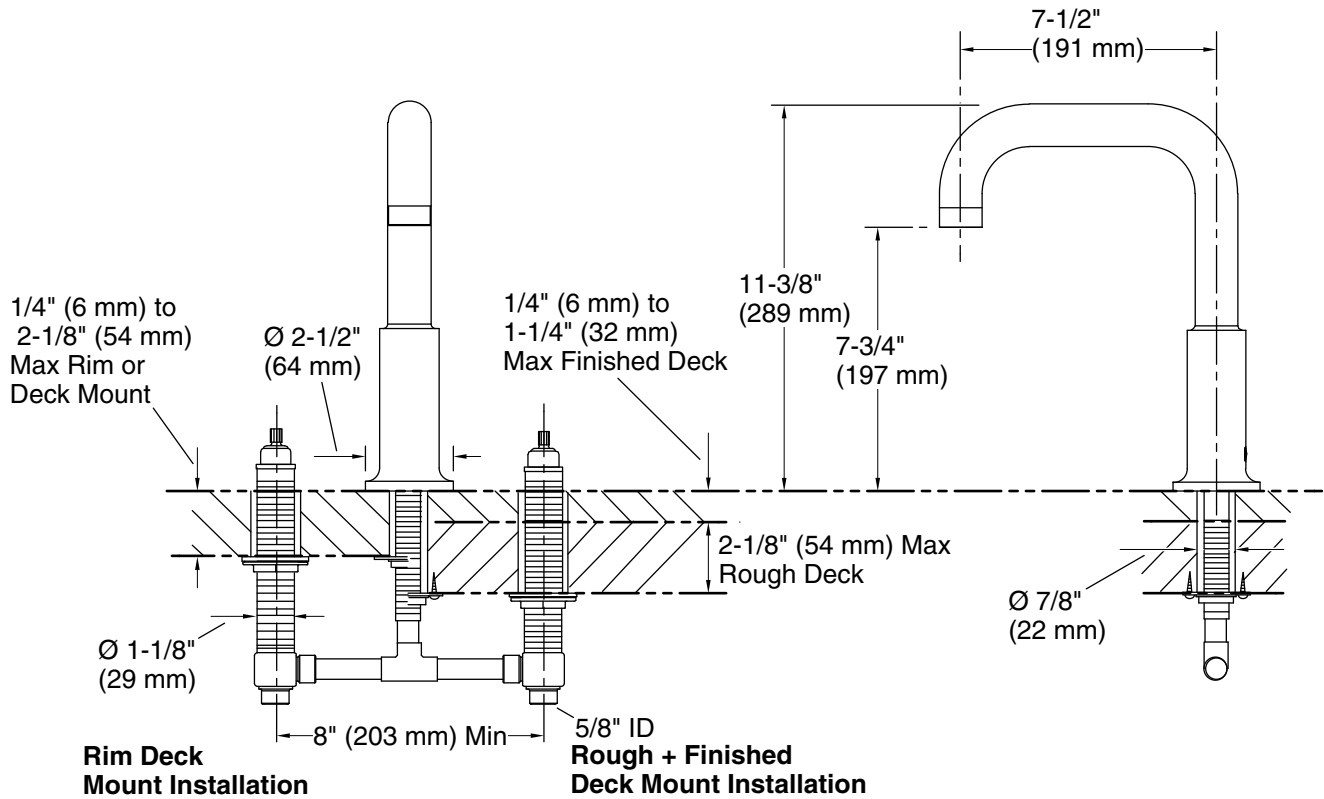

## Technical Information

All product dimensions are nominal.

### Spout:

Spout reach: 7-1/2" (191 mm)

## Notes

Install this product according to the installation instructions.

ADA, OBC, CSA B651 compliant when installed to the specific requirements of these regulations.