



# FlexGrow Tomato Cage 3-Panel & Modular Trellis User Manual

Models: VPSS3PTTDG-3, VPSS3PMCDG-4, VPSSFMTDG-12

Gardening Made Easier. Anytime, Anywhere.

Copyright © 2025 Vego



  
**Gardening  
Made Easier.  
Anytime,  
Anywhere.**

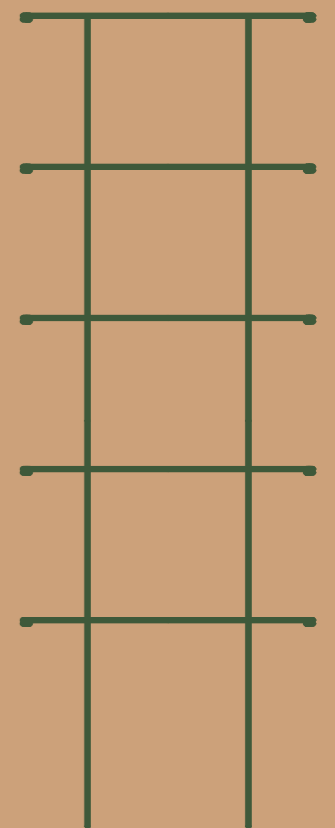
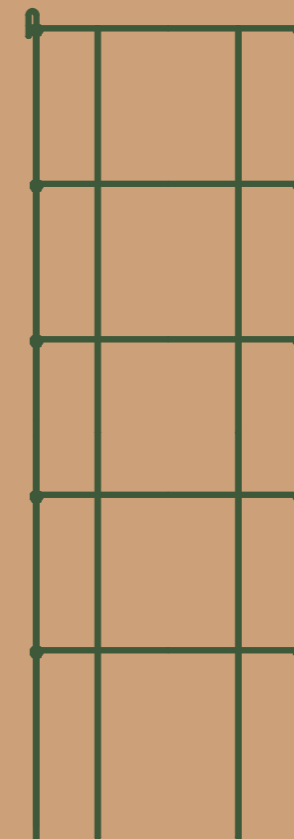
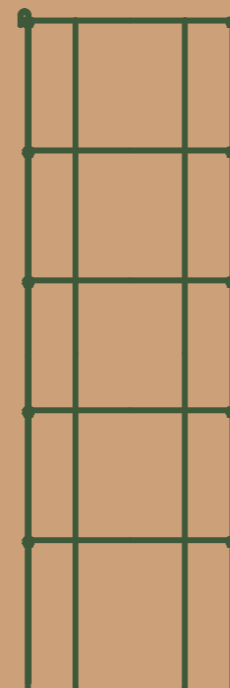

## Contact Us

 +1 (866) 597-1888

 Vego Garden Academy







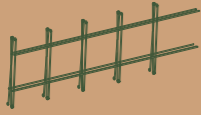

 hello@vegogarden.com

 vegogarden.com

 vego\_garden

 Houston, TX

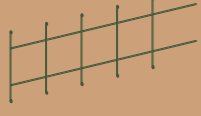
## Parts List

Model Part Name	VPSS3PTTDG-3 3-Panel 14.5"	VPSS3PMCDG-4 3-Panel 11.5"	VPSSFMTDG-12 Modular Trellis
 P1	3		
 P2	3		
 P3	3		12
 P4	3		
 P5		4	
 P6		4	
 P7			12
 P8	3	2	

## Safety Precautions

This product may contain sharp metal corners and edges. To prevent injury:

- Handle with care at all times
- Wear gloves, closed-toe shoes & long pants when handling
- Work on a stable, clean surface away from children and pets
- Follow all instructions carefully and use tools only as directed

If you are unsure about any step, pause and seek assistance.



## Installation Preparation

As part of our commitment to the environment, this package contains no plastic filler materials.

The product is designed with a “shape memory” structure, so during shipping it may arrive with slight bends or warping.

This is normal and can be easily corrected by hand—no tools are needed.

Our tests confirm that minor shipping bends do not affect the product’s strength, stability, or performance.

**1** If P1 or P2 are deformed, you can straighten them by hand.

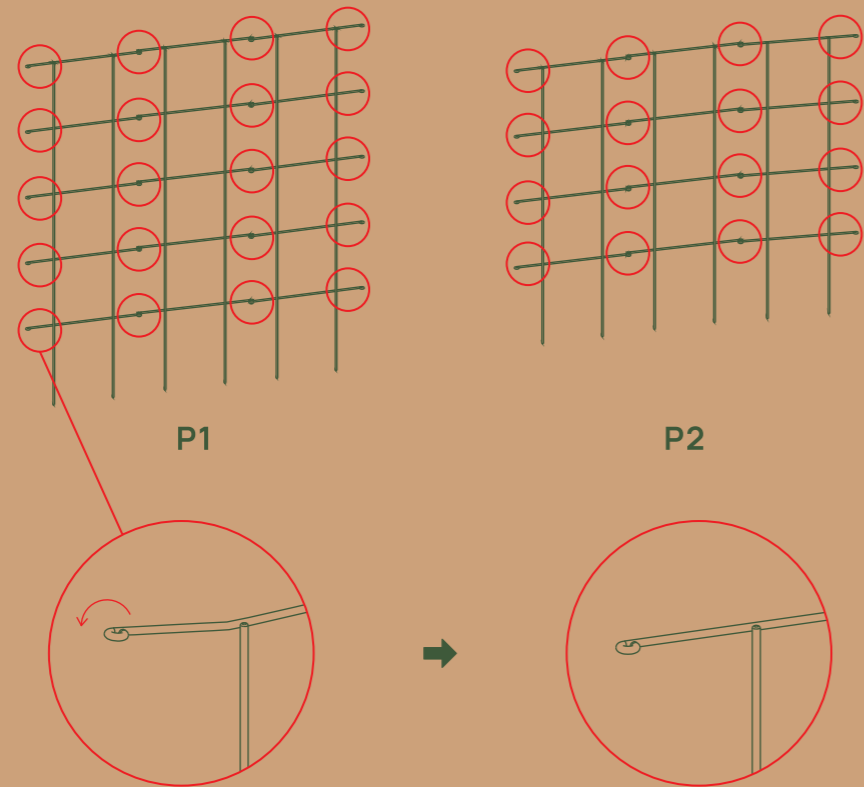

**2a** For shorter plant needs:

Place P1 flat on the ground, fold into a triangular shape, and slide P3 into the open corner holes of P1 as shown in the diagram. If desired, repeat for P2, using the P4 rod. You can now insert the legs into the soil and get to growing!

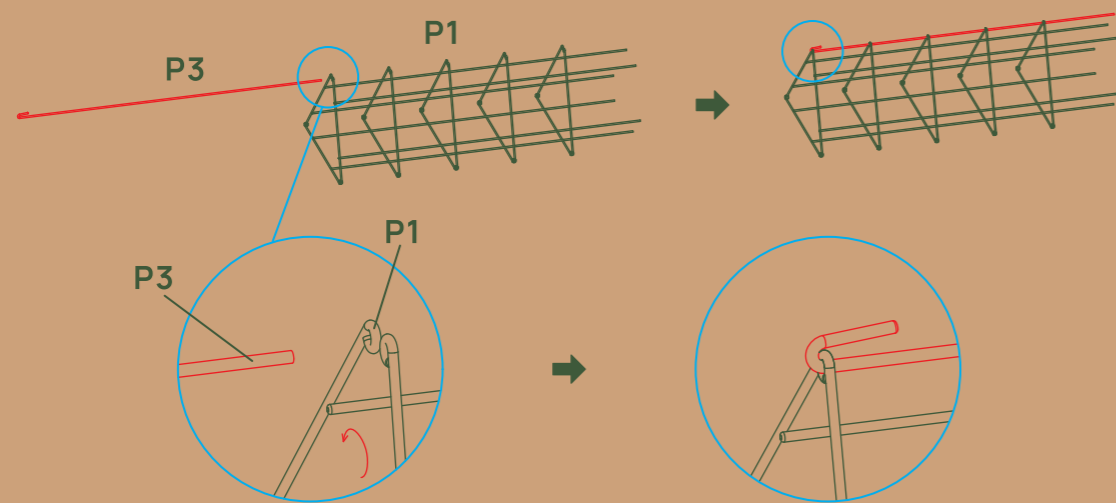

**2b** For taller plant needs:

Place one P1 flat on the ground. Fold into a triangular shape. Slide P3 into the open corner holes of P1, skipping the top two links and starting with the third as shown in the diagram.

This assembled cage will be referred to as S1. Please set it aside for later.

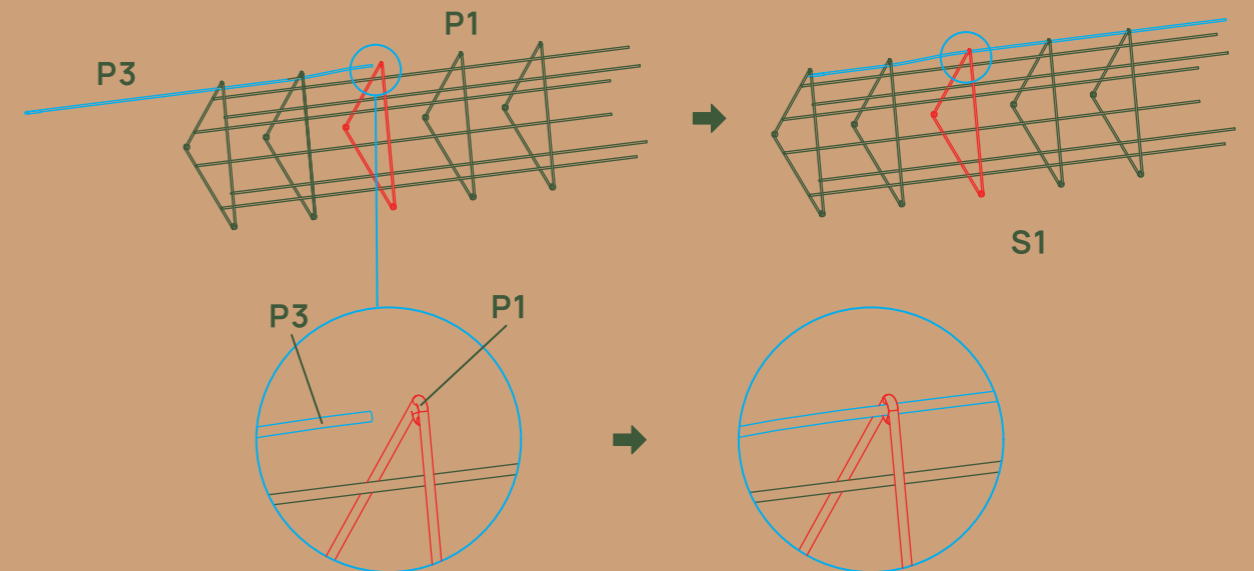

**3** Place P2 flat on the ground. Fold into a triangular shape, and slide P4 into the open corner holes of P2 as shown in the diagram.

This assembled cage will be referred to as S2.

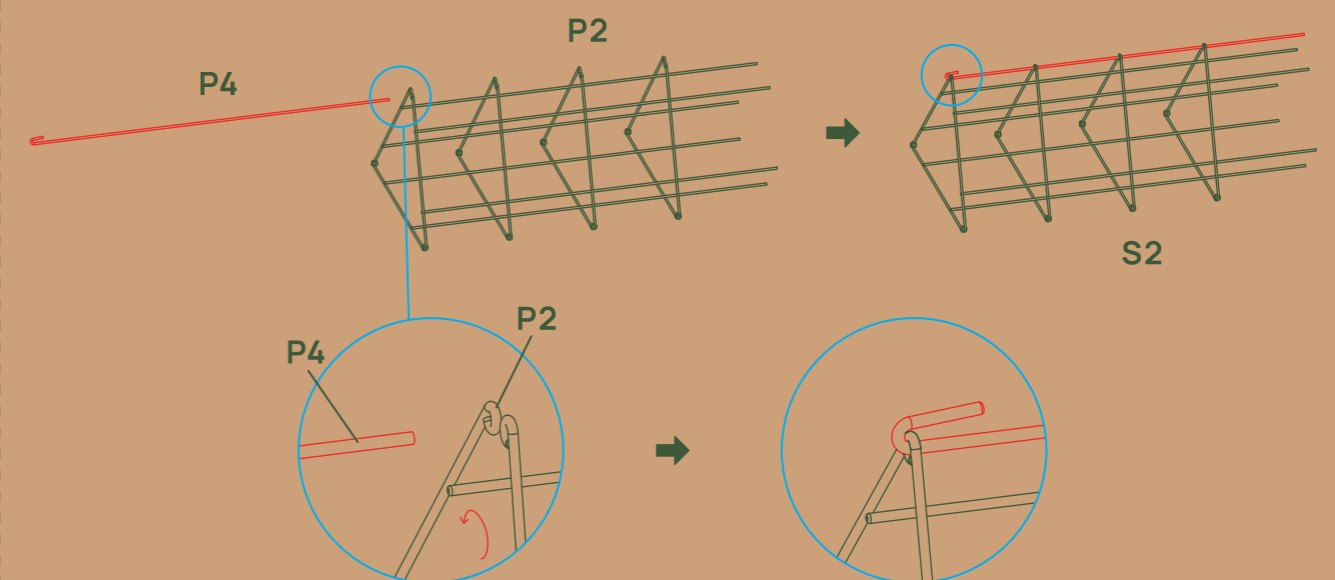

FLEXGROW 3-PANEL TOMATO CAGE II.5"

VPSS3PMCDG

- 4 Insert the top cage (S2) into the bottom cage (S1). The P4 rod from S2 should slide into the top two unused links of S1.

Hook the top of the P3 rod from S1 to the bottom crossbar of S2.

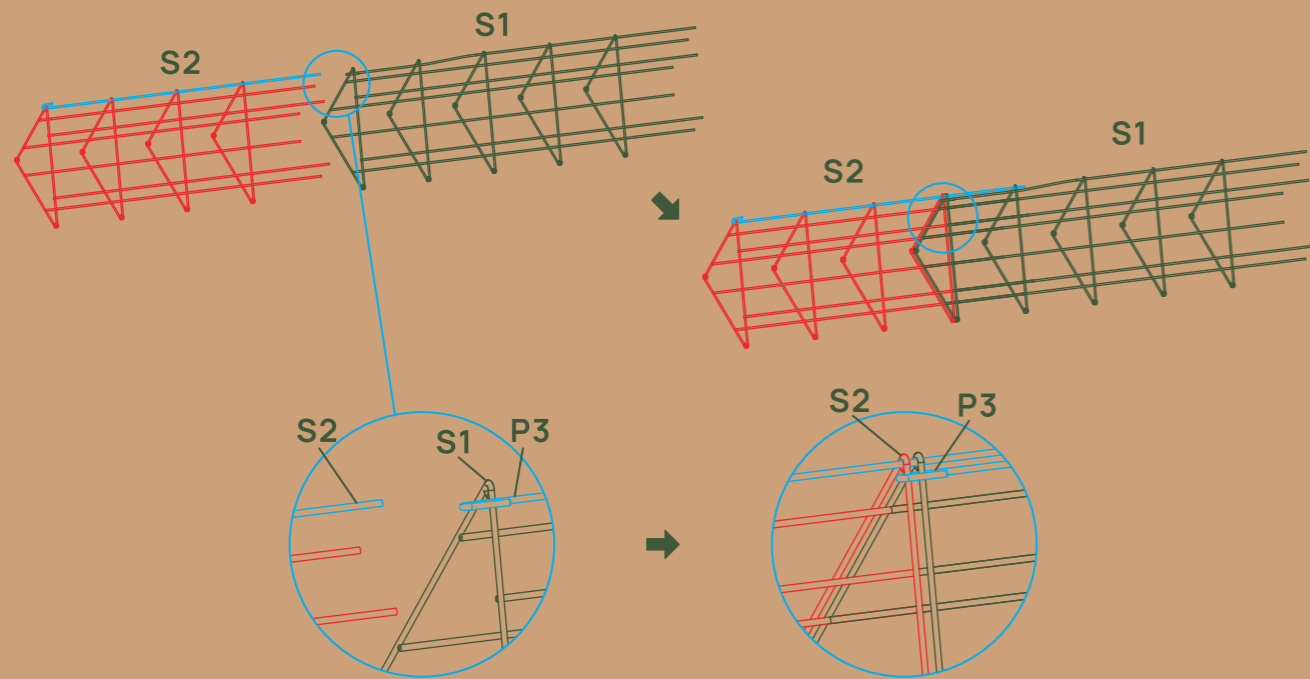

- 5 Attach a clip (P8) to the side opposite the corner with the vertical inserted rod.

**Note:** Insert the two steel wires into the corresponding slots of the connector, then close the connector.

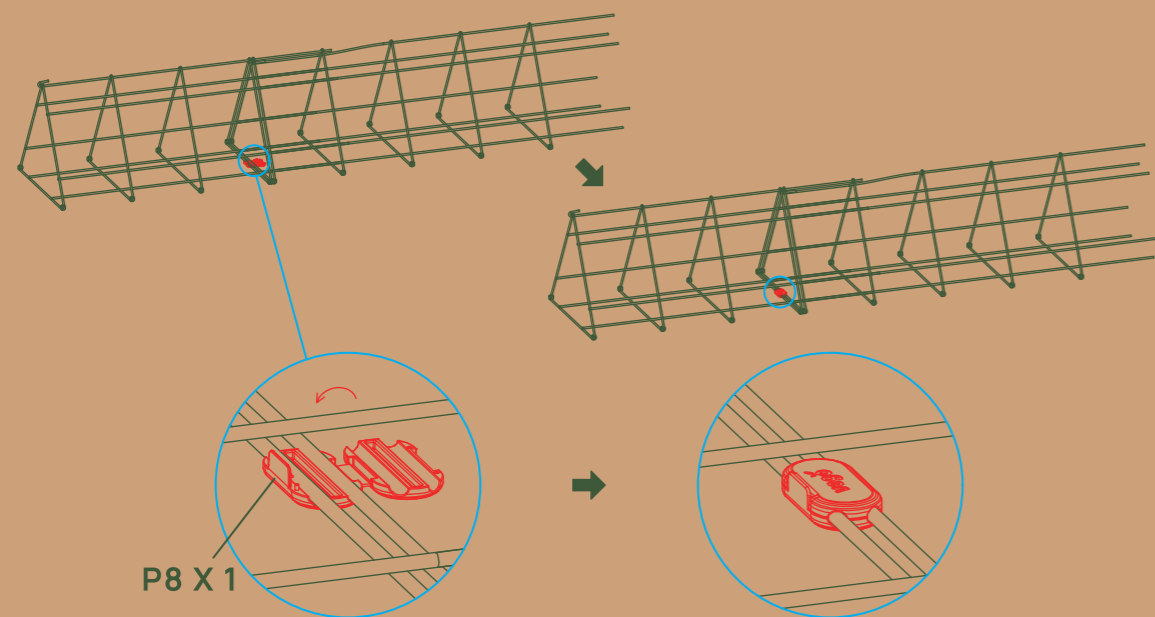

- 1 If P5 are deformed, you can straighten them by hand.

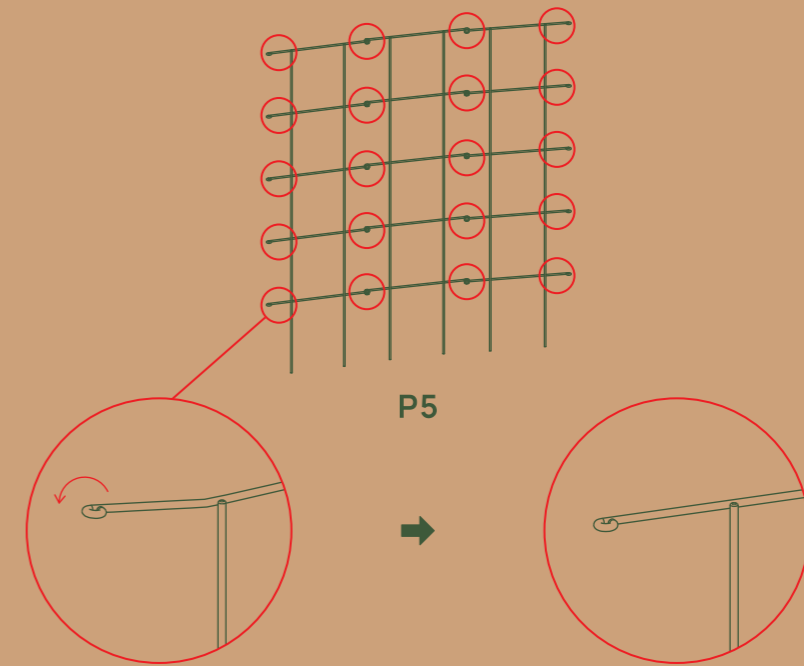

- 2 For shorter plant needs:

Place P5 flat on the ground, Fold into a triangular shape, and slide P6 into the open corner holes of P5 as shown in the diagram. Repeat for each P5. You can now insert the legs into the soil and get to growing!

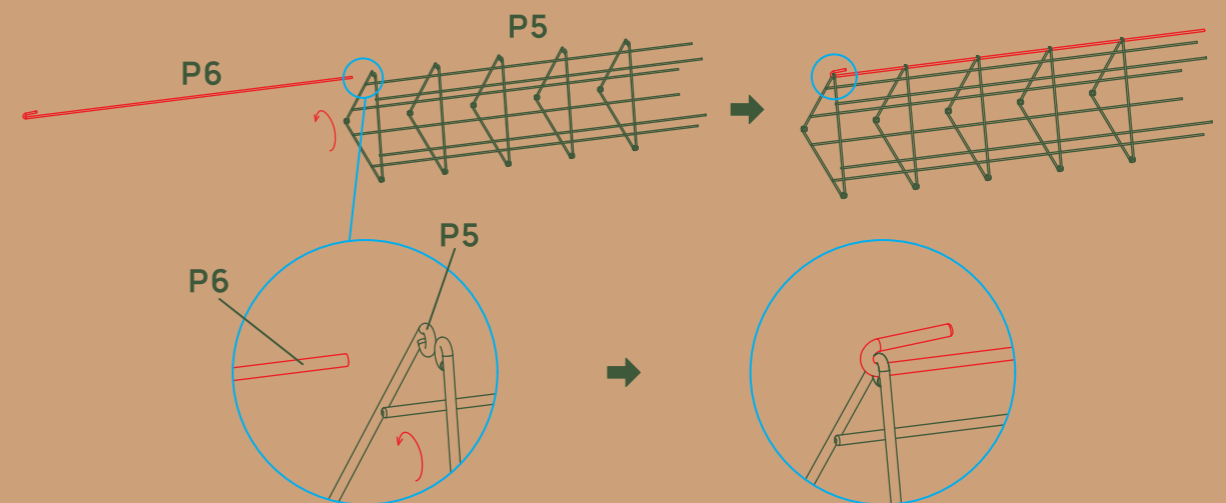

- ! For taller plant needs: Installation method is the same as VPSS3PTTDG.

**1** If P7 are deformed, you can straighten them by hand.

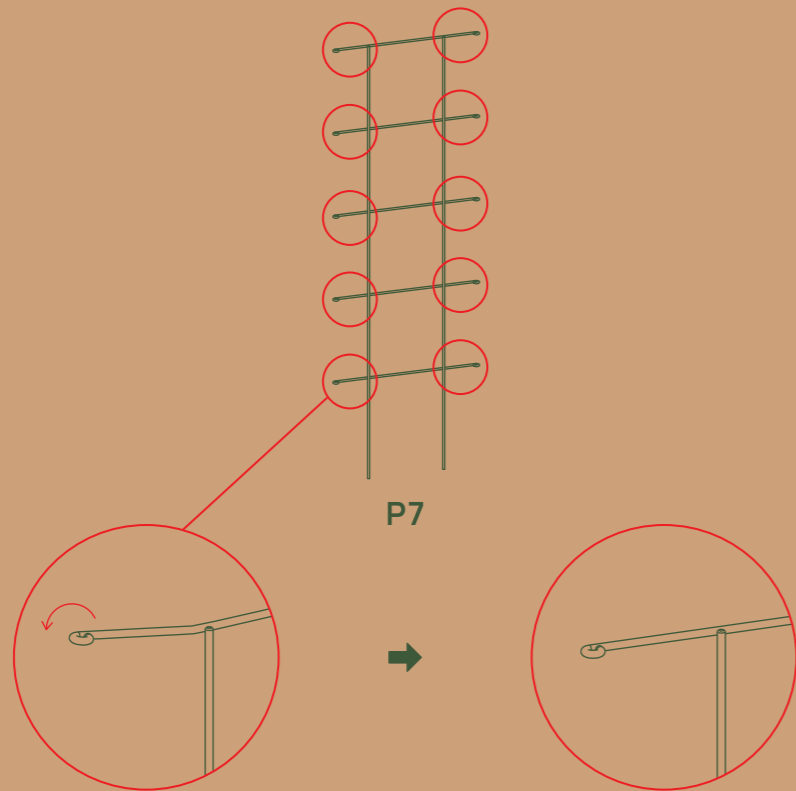

**2** Place two or more panels flat on the ground and align the holes at one end as shown in the diagram.

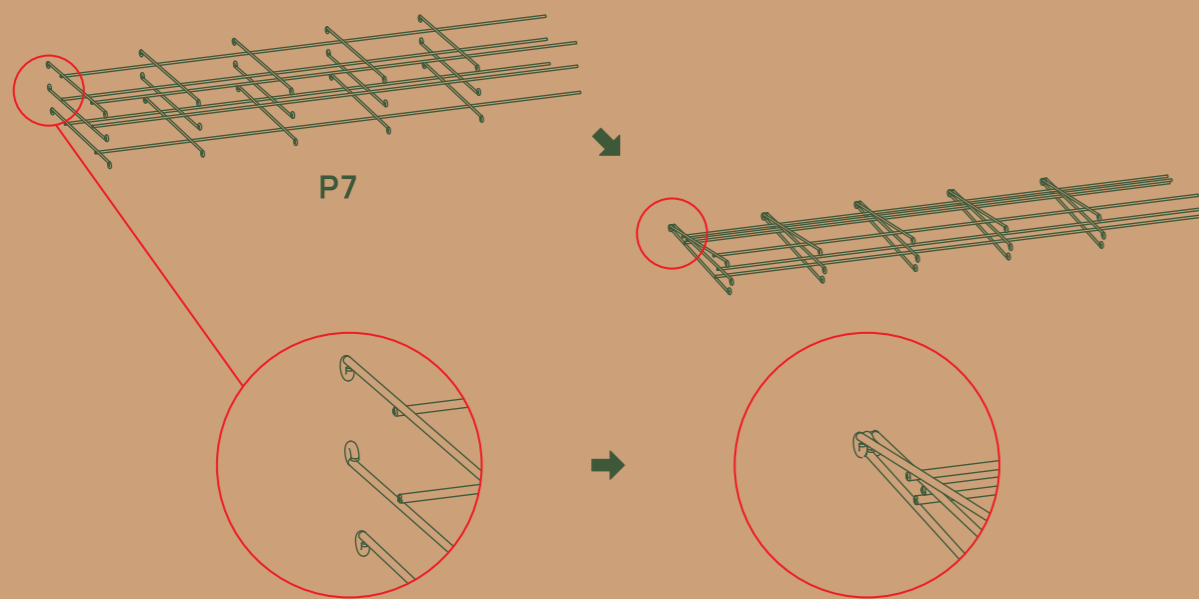

**3** Slide P3 rod into the open holes of P7 as shown in the diagram.

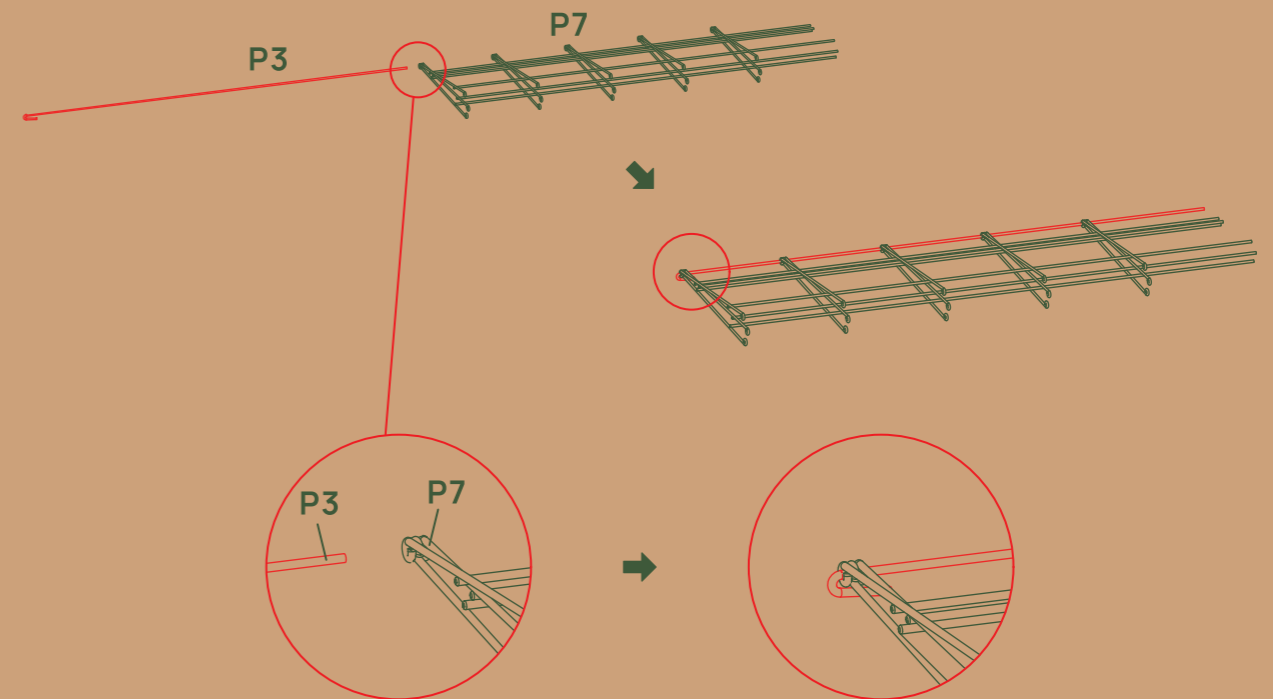

## Versatile Design

You can assemble the product in different configurations to suit your needs. Below are a few simple examples of VPSSFMTDG.

**1** Three-piece.

**Note:** Use 3 single panels, 1 rod.

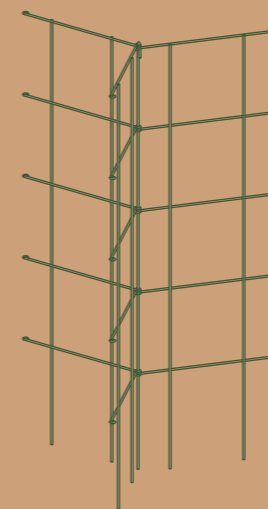

**2** Triangle.

**Note:** Use 3 single panels, 3 rods.

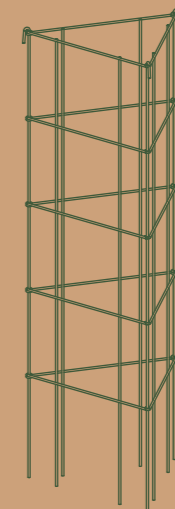

**3** Square.

**Note:** Use 4 single panels, 4 rods.

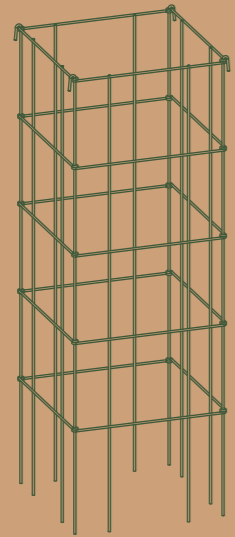

**4** Hexagon.

**Note:** Use 6 single panels, 6 rods.

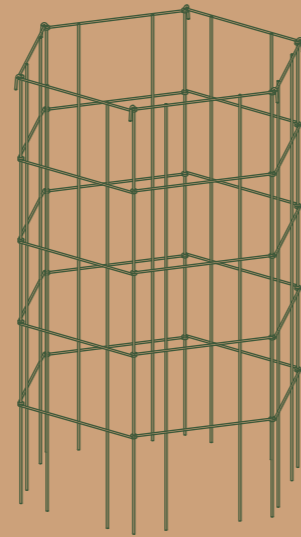

 **Important**

For your safety, please ensure the structure is securely fastened using connectors and ties. In windy areas, be sure to anchor your tomato cages firmly to the ground. This will keep strong winds from tipping it over and harming your plants.

 **Maintenance**

To extend the life of your trellis, we recommend storing it in a dry, covered place at the end of the season. The trellis is finished with a protective powder coating. If the coating gets scratched, simply touch it up with exterior paint or polyurethane to help prevent rust.

 **Warranty and Support**

**Tomato Cage Warranty**

Warranty: 3 Years Structural Guarantee

Exclusions: Damage caused by misuse, improper installation, or modifications is not covered.

**Customer Support**

For any issues, please contact our customer support team via:

Email: [hello@vegogarden.com](mailto:hello@vegogarden.com)

Website: [www.vegogarden.com](http://www.vegogarden.com)



**Gardening  
Made Easier.  
Anytime,  
Anywhere.**

---