

FL-002

IMPORTANT SAFETY INSTRUCTIONS:
THIS PORTABLE LAMP HAS A
POLARIZED PLUG (ONE BLADE IS WIDER
THAN THE OTHER) AS A SAFETY
FEATURE TO REDUCE THE RISK OF
ELECTRIC SHOCK. THIS PLUG WILL FIT
IN A POLARIZED OUTLET ONLY ONE
WAY. IF THE PLUG DOES NOT FIT FULLY
IN THE OUTLET, REVERSE THE PLUG. IF
IT STILL DOES NOT FIT, CONTACT A
QUALIFIED ELECTRICIAN. NEVER USE
WITH AN EXTENSION CORD UNLESS
THE PLUG CAN BE FULLY INSERTED. DO
NOT ALTER THE PLUG.

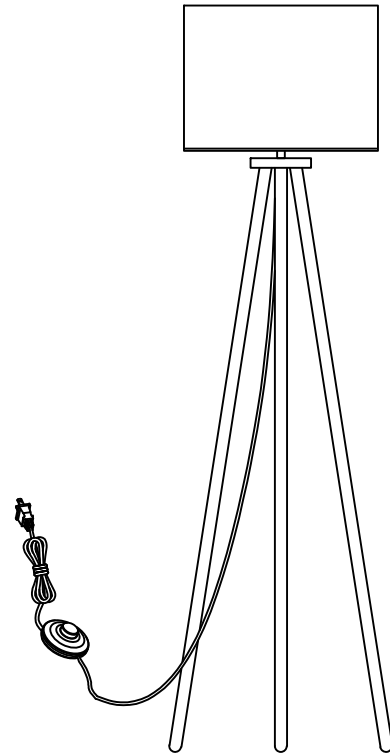

1

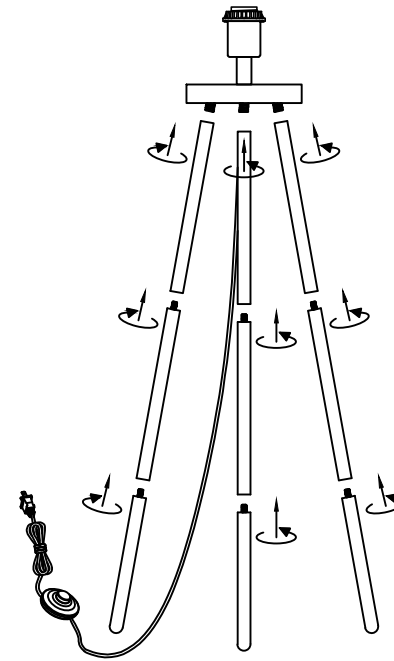

2

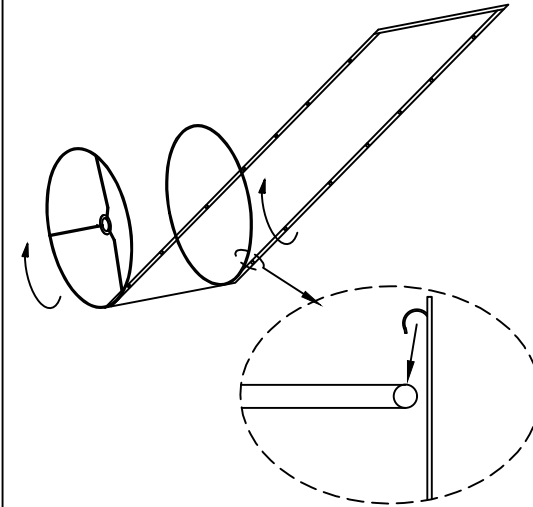

3

