

Assembly Instructions

Caution: You must read this before you proceed

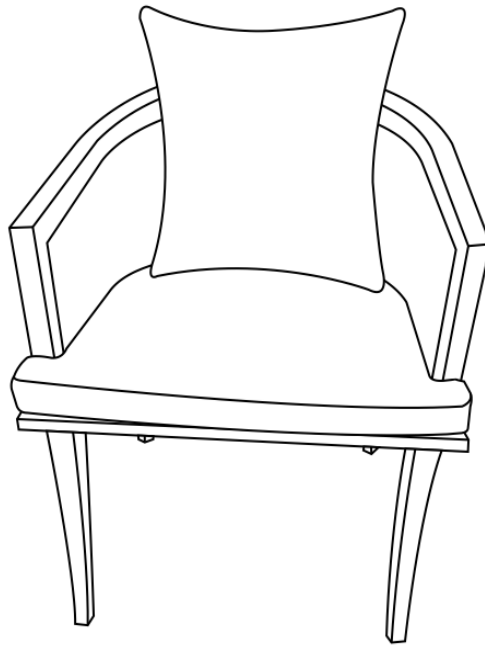

Chair



Part List

Label	Picture	Description	QTY
A	A line drawing of a rectangular seat cushion with a slightly curved top edge.	Seat	1
B	A line drawing of a single front leg, which is slightly curved and tapers towards the bottom.	Front Legs	2
C	A line drawing of a single back leg, which is slightly curved and tapers towards the bottom.	Back Legs	2
D	A line drawing of a square back cushion with a slightly curved top edge.	Back cushion	1
E	A line drawing of a rectangular seat cushion with a slightly curved top edge.	Seat Cushion	1





Hardware

Label	Picture	Description	QTY
①		Bolt (M6X12mm)	13
②		Allen Key	1

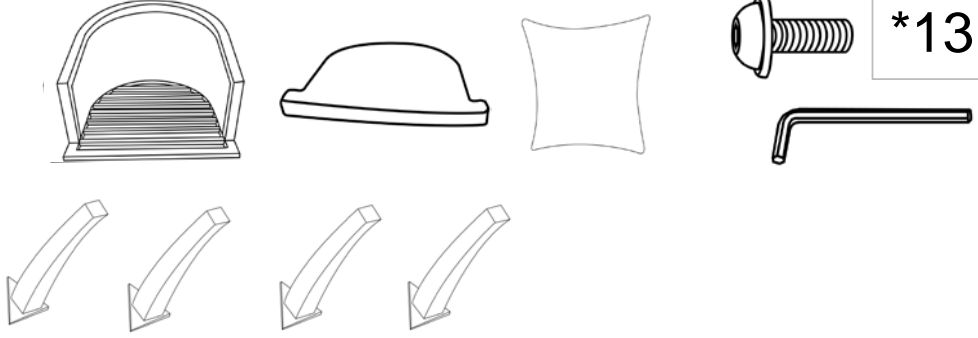
Assembly Preparation

Before Beginning Assembly:



-  • Read instructions, cover to cover-
-  • Have 2 adults on hand for assembly-
-  • Do not assemble on flooring or carpet-
-  • Assemble on a clean non-marring surface (packing foam)-
-  • Save all packaging until finished-

Assembly Steps

Overview

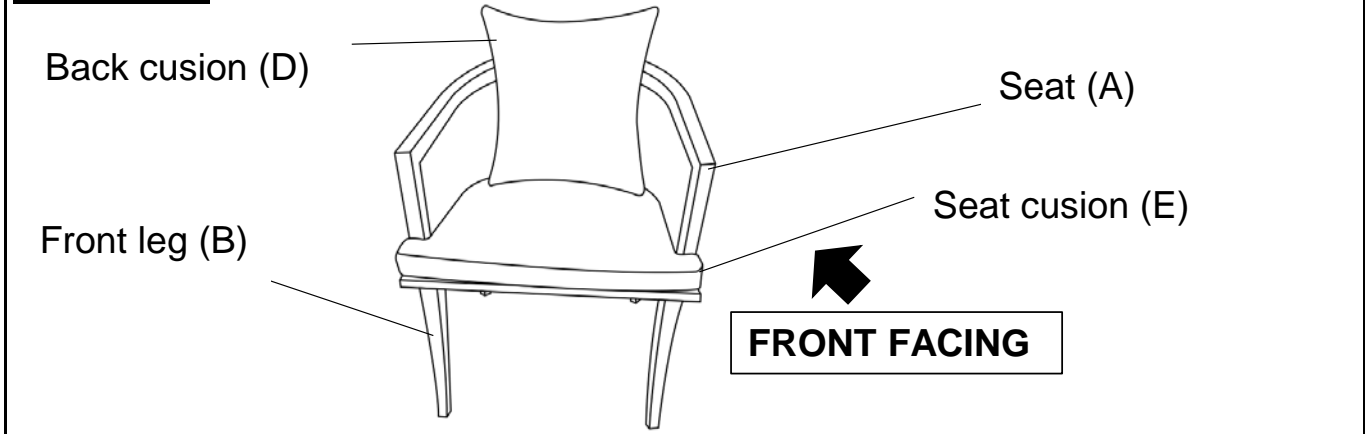

This Chair has multiple parts and may require up to 30 minutes to assemble. To give you an overview of the the Chair parts, the above picture is to help you put the various parts into perspective. Please read through the instructions below to familiarise yourself with the parts and steps before assembly.

Step 1

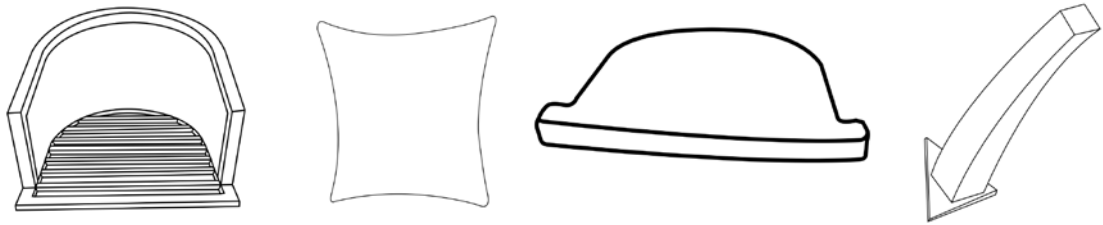

Unpack and place all parts on a clean, non-marring surface.

Step 2

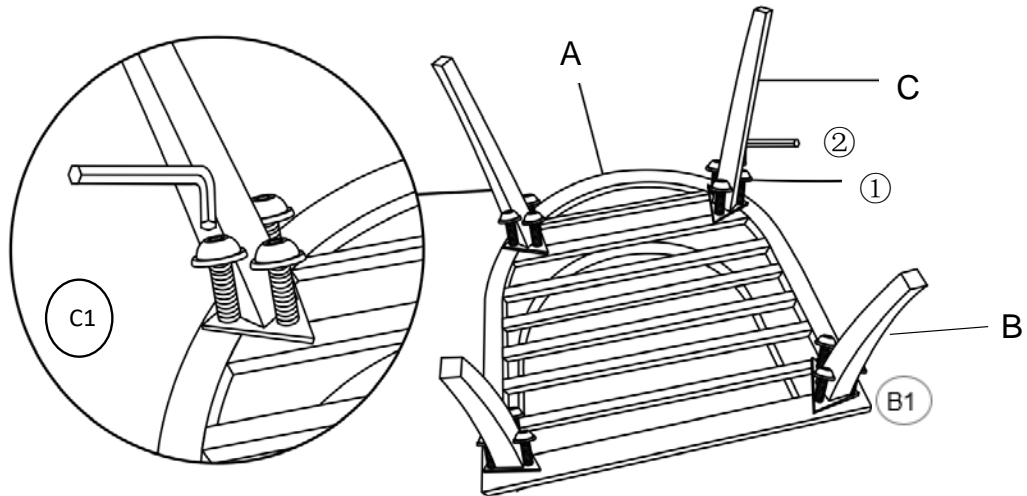

Place the Seat(A) facedown onto a clean, non-marring surface.

Align and attach the Seat(A) to Front Legs(B) using Bolts(①) with Allen Key(②).

Ensure the Leg mounting positions(B1) match the Seat mounting points(B1).

Align and attach the Seat(A) to Back Legs(C) using Bolts(①) with Allen Key(②).

Ensure the Leg mounting positions(C1) match the Seat mounting points(C1).

Do not fully tighten the Bolts.

Step 3

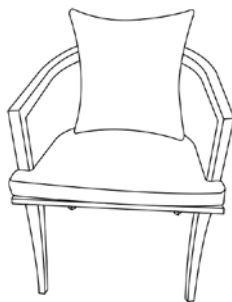

Stand the chair up.

Carefully exert pressure floorwards onto the chair with both your hands.

This pressure will help the Legs and chair Top reach full alignment status.

Check for wobbles on a LEVEL surface.

If no wobbles are found proceed to tighten the Bolts in a sequential manner, until evenly secured.

When tightening the Bolts tighten sequentially.

Do not tighten any Bolt fully and then move on towards the next one.

If there are still wobbles, loosen the Bolts and execute the same above process.

If the Chair is not Stable it could lead to damage to the product.

Step 4

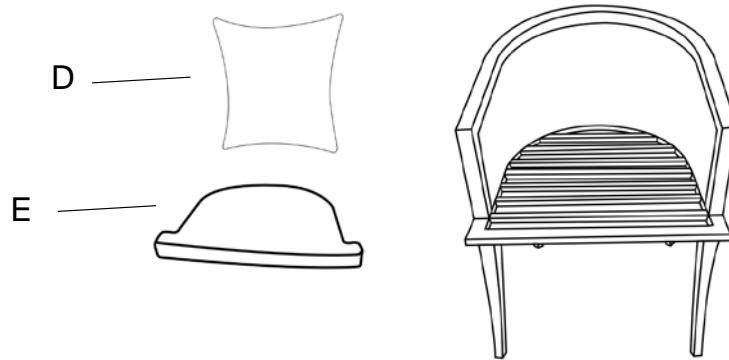



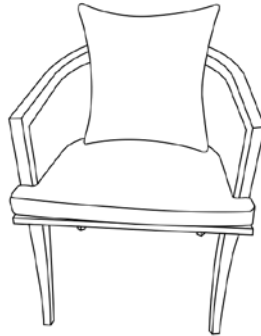

















Put the Back Cushion (D) and Seat Cushion (E) on the seat.



Your Chair is ready for use.

This Chair can only be used on a flat and level surface.

Care & Maintenance

-   ● Do not put hot items directly on furniture surface
 -   ● Do not clean furniture with harsh cleansers or polish.
 -   ● To obtain the longest lifespan of your outdoor products, minimizing exposure to direct sunlight is recommended.
 -   ● Children should not climb or jump on the furniture.
 -   ● Do not write on furniture without a padded barrier to protect the surface.
 -   ● To obtain the longest lifespan of your outdoor products, avoid extended and lengthy exposure to rain, snow, and direct sunshine. Whenever possible cover the product and /or place under patio or awnings.
 -   ● Not for commercial use. For residential use only .
 -   ● Stains may be removed with mild soap solution and damp cloth.
 -   ● Keep away from sources of ignition.
-
-   ● Dust and pick-up spills using a clean, non-colored, lint-free cloth.