

Recliner Assembly Instructions

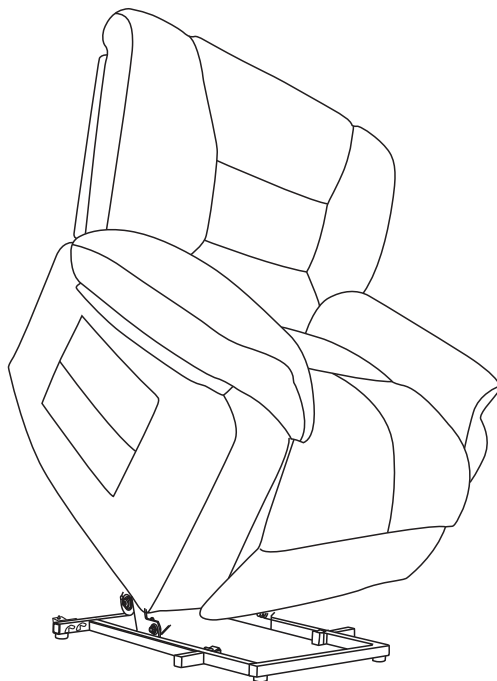

THIS INSTRUCTION BOOKLET CONTAINS **IMPORTANT** SAFETY INFORMATION.
PLEASE READ AND KEEP FOR FUTURE REFERENCE.

Accessories Display

CAUTION: Please check and ensure all the things are in the package. You can contact us if something is not included. We will reply within 24 hours and try our best to solve it.



1. Back Cushion* 1pc



2. Back Frame* 1pc

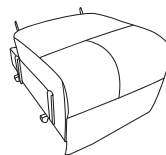

3. Seat* 1pc

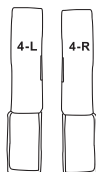

4. Backrest Ear Part* 2pc

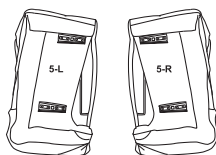

5. Armrest* 2pc



6. Armrest Pillow R&L* 2pc

IMPORTANT!

Please turn the seatbase over and
Find the components:
4, 5-L & Accessory Box

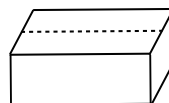

7. Accessory Box

Find a small accessory box in the bottom of the seatbase, take them out and then finish your assembling of the sofa.
Accessories displayed in the next page.

Accessories Display

CAUTION: Please check and ensure all the things are in the package. You can contact us if something is not included. We will reply within 24 hours and try our best to solve it.



A Massage Remote * 1pc



B Power Cord * 1pc



C Lift Remote * 1pc



D Screw * 4pcs

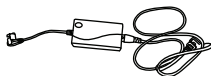

E Power Source * 1pc



F Nut * 4pcs

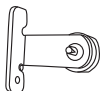

G Supporting Feet * 2pcs

Armrest Assembly

CAUTION: At least two adults are required to safely complete performing this task.
Other lifting attempts may risk back injury due to large and heavy part(s).

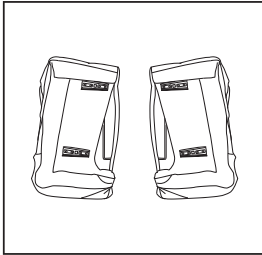

01 Find the accessories on the picture placed on the ground for subsequent installation.

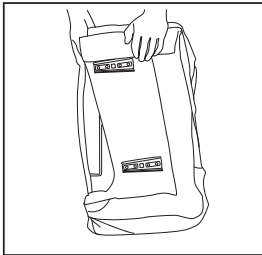

02 It is recommended to prop the armrests vertically.

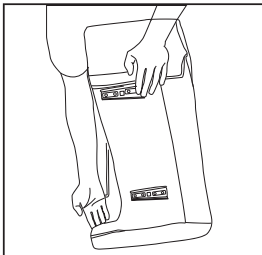

03 It will be easier to open the armrest from below.

Armrest Assembly

CAUTION: At least two adults are required to safely complete performing this task.
Other lifting attempts may risk back injury due to large and heavy part(s).

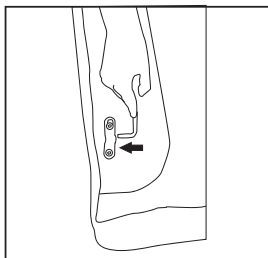

04

Once fully opened, insert the inner fixture into the reserved hole.

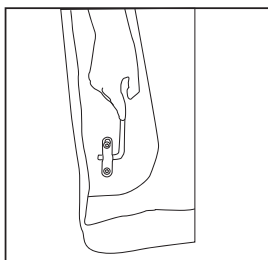

05

Make sure it is fully inserted and the armrest is assembled.

Armrest Assembly

CAUTION: At least two adults are required to safely complete performing this task.
Other lifting attempts may risk back injury due to large and heavy part(s).



06

Paste accessory **6-R** on the Velcro back of the armrest to complete the installation;

The other armrest bag is installed in the same way.

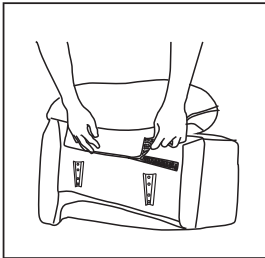

07

Align accessory **6-R** with the zipper on the armrest to complete the installation;

The other armrest bag is installed in the same way;

The Armrest Assembly setps for 5-L/6-L Same As Above.

Seating Assembly

CAUTION: At least two adults are required to safely complete performing this task.
Other lifting attempts may risk back injury due to large and heavy part(s).

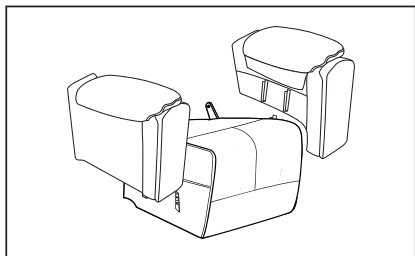

01 Align the pins on the armrest with the pins on the seat, and push down to install the armrest on the seat;

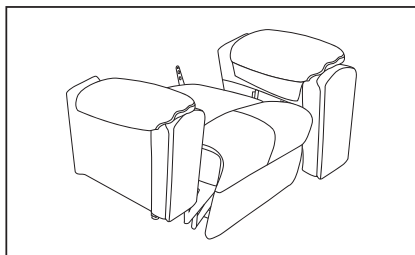

02 The installation operation is the same on the other side.

Backrest Assembly

CAUTION: At least two adults are required to safely complete performing this task.
Other lifting attempts may risk back injury due to large and heavy part(s).

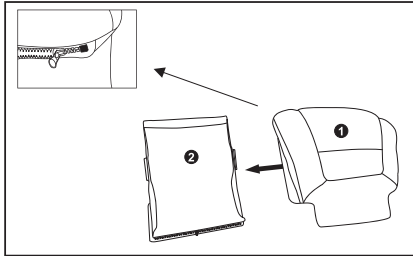

01 Assemble Part **1** and Part **2** and zip them up;

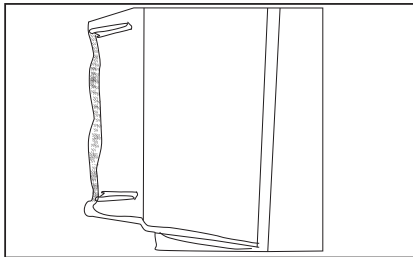

02 Arrange the power cord at the end of the backrest and paste the Velcro.

Sofa Assembly

CAUTION: At least two adults are required to safely complete performing this task.
Other lifting attempts may risk back injury due to large and heavy part(s).

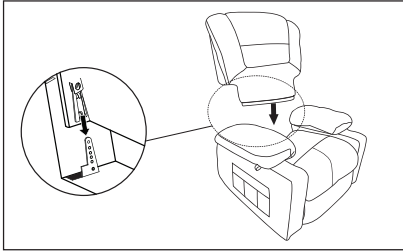

01 Align the pins of the backrest with the pins of the seat, and press downward to assemble the backrest and seat; Try shaking the backrest after installation, if one side wobbles up and down, it is not fully assembled.

Please make sure to hear a 'click' sound

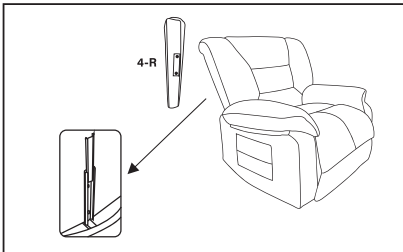

02 Align the pins of part **4-R** with the pins on the back of the backrest to assemble;

Assemble the other side in the same way;

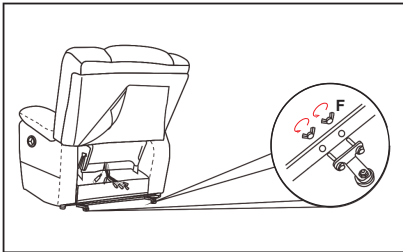

03 Take out supporting feet and nuts from a accessory box. Assemble the two supporting feet as shown on the bottom of mechanism to avoid toppling and falling.

Wire Assembly

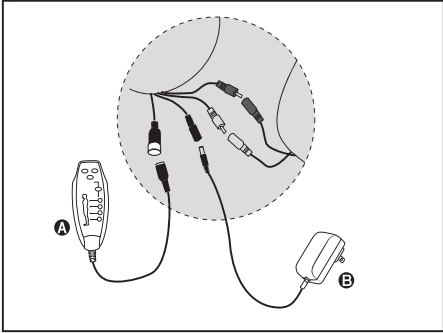

01 Swivel Rocker/Manual Recliner

Assemble by color,
The white line and red line respectively
control massage and heating.

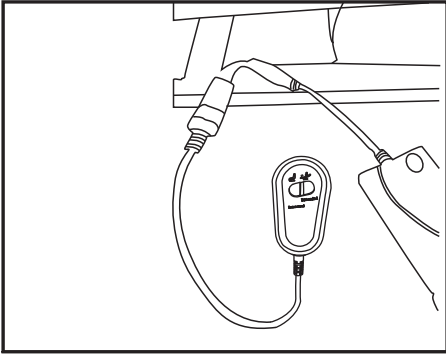

02

Connect motor adapter D,
elevator remote control E,
and motor power cord C together

Massage operation

INTENSITY: Change intensity (HIGH or LOW) during all modes.

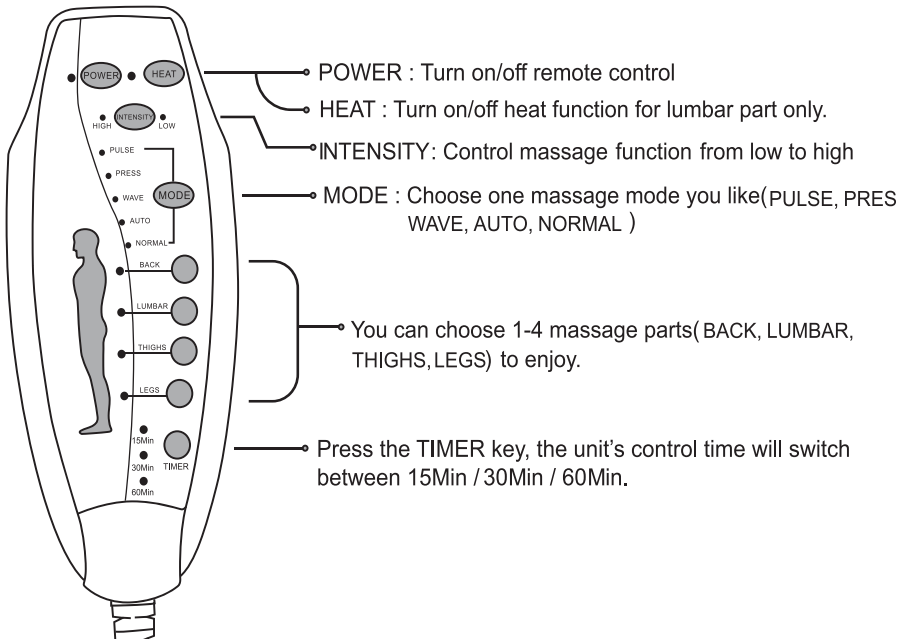

We recommend that the unit be used only for a few minutes initially, to allow your body to get used to the massage sensation. Gradually increase the length of time you use the massage function, over the first few periods of use. Should you experience any adverse reactions, stop using immediately and consult your medical practitioner.

RECLINE & FOOTREST OPERATING

A. How to recline

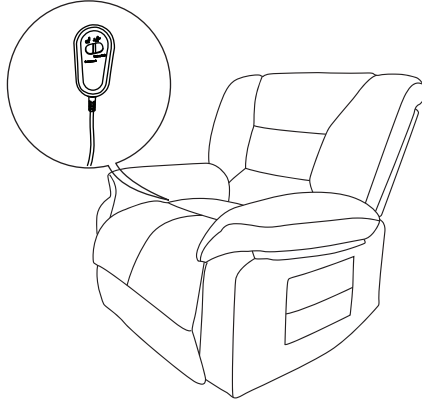

1. Pull the handle to lift the footrest separately.

2. Lift

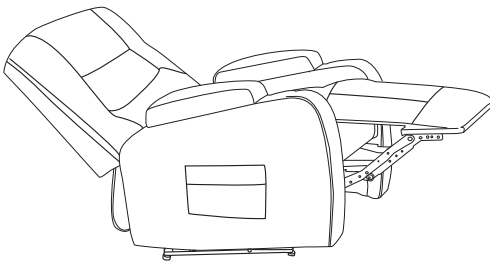
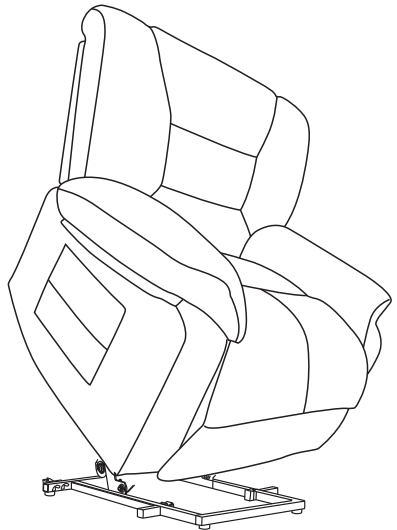

3. Recline

USAGE

Leave
enough space
for reclining back

45cm

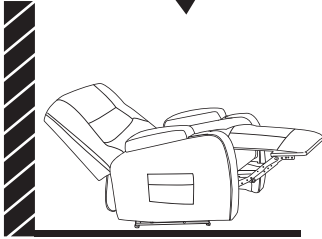
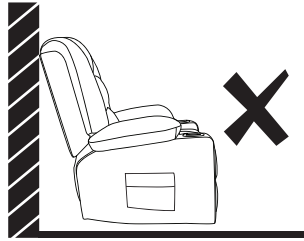
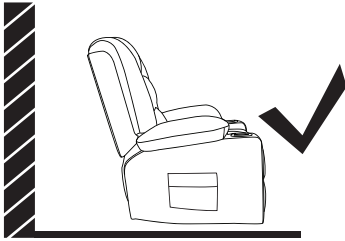

The recliner should be placed 45cm away from the wall, and the reclining function can be used normally.

PROPER USAGE



01 Steps to safely stand up from your Recliner Chair

1. Store the remote control safely in the seat's side pocket
2. Plant feet firmly on the ground
3. Evenly distribute weight on both arms of the chair
4. Slowly stand up from upright position

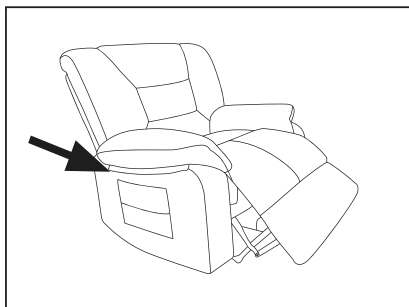

02 *Remember to store remote control safely in the seat's side pocket when it is not in use.

*Fabric will fade or discolor in direct sunlight.
Minimize exposure to direct sunlight to extend the life of your furniture.

IMPROPER USAGE

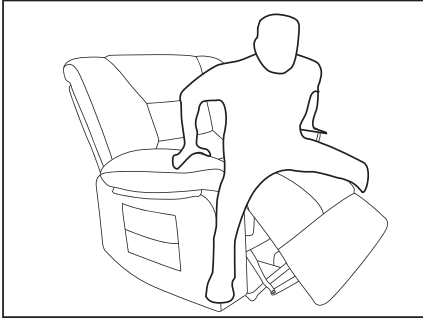

01 DO NOT
stand up when the footrest
is in the upright position.

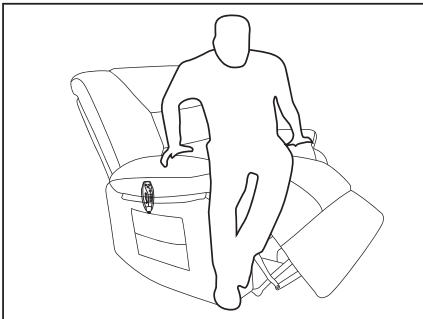

02 DO NOT
stand up from your recliner chair
with uneven weight.



03 DO NOT
stand up from your Recliner chair
with only one arm.

IMPROPER USAGE

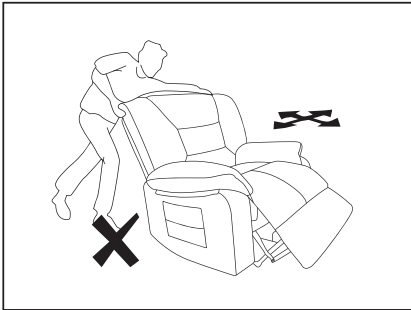

04 As all action products contain moving parts, handle all items with care.

* Only move the recliner when it is in the 'upright' or 'closed' position. Never attempt to move the recliner when it is in any of the reclining positions. Always use the arms to move the Recliner-DO NOT use the backrest or backrest ear parts.

WARRANTY

So glad you have completed the assembly and can enjoy it. If you are satisfied with our products, thank you for showing your favored massage recliner to your around.

Our products come with a 2-month warranty, you can feel free to contact us at any time.

AFTER-SALE POLICY

1. **For return reason:**

Wrong purchase, bought by mistake, no longer needed, doesn't meet expectation, a size smaller than expectation, customer need to cover the return shipping fee.

2. **For cancel order:**

Customer needs to pay for shipping fee and carrier handle fee if the item has been shipped out.

For change address: customer needs to pay for extra shipping fee and carrier handle fee if the item has been shipped out.

3. **Customer Service:**

Any problem with the product or shipping issue, please feel free to contact us, we will try our best to serve and help.

Dear Customer,

Thank you for choosing us.

For safe use, please read this manual before installation, and keep it for after use. Please feel free to email us if you have any concerns about our products. We'll reply within 24 hours.

The following are the things you need to pay attention to so that we can provide you with services when you encounter problems during the installation and use of the product:

- When the product is damaged due to courier problems, please contact our customer service in time for verification.
- We will rectify the issue as soon as possible;
- We give a 60-day quality assurance;
- We provide a 7-day no-reason return service (note that the returned product will not affect the secondary sales);

We offer product explanations, installation instructions, product maintenance and maintenance methods.

If you feel satisfied with our product and service,

- Please set our store as your favorites;
- Please recommend our products to your friends;
- Please and leave us your purchase experience in our store or product page.

Feedback or reviews from you will greatly help us offer better services to players around the world.

Best regards

Avoid using sharp objects such as a knife to cut open packing as you may accidentally damage the upholstery.
