

INSTRUCTION
 ANWEISUNG
 取扱説明書
 INSTRUCTION

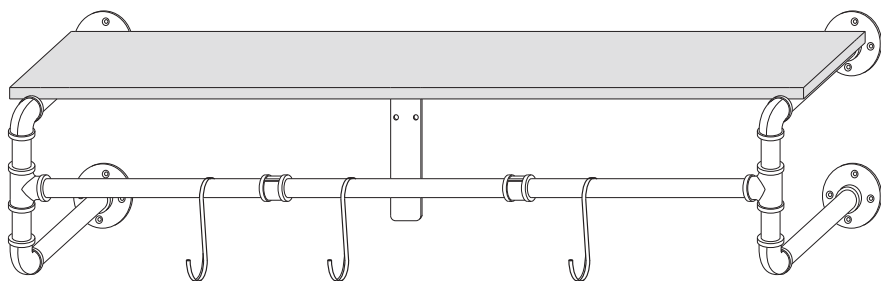

1

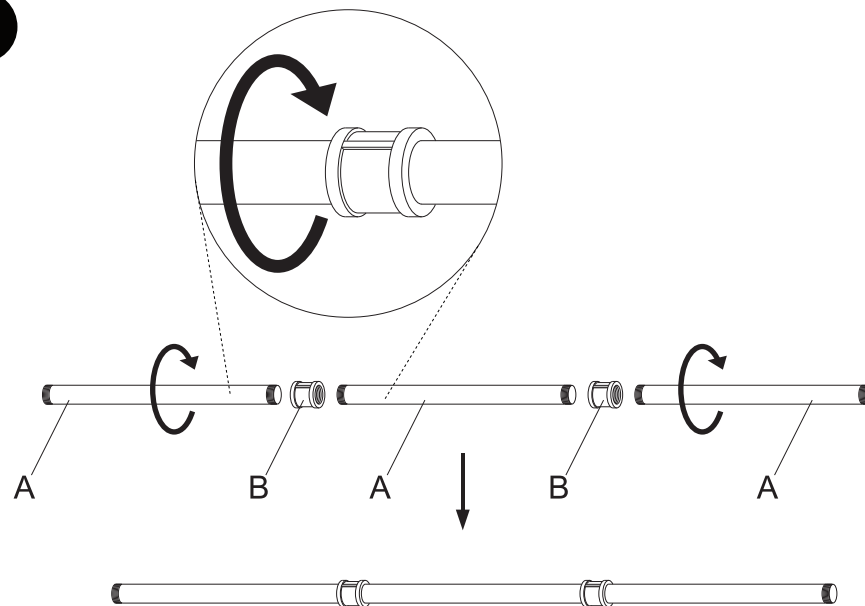

A *3

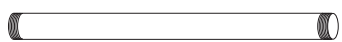

B *2



C *2

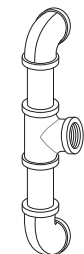

D *1



E *4

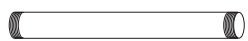

F *4



G *1



H *3



J *2



K *18



L *18



M *6



2

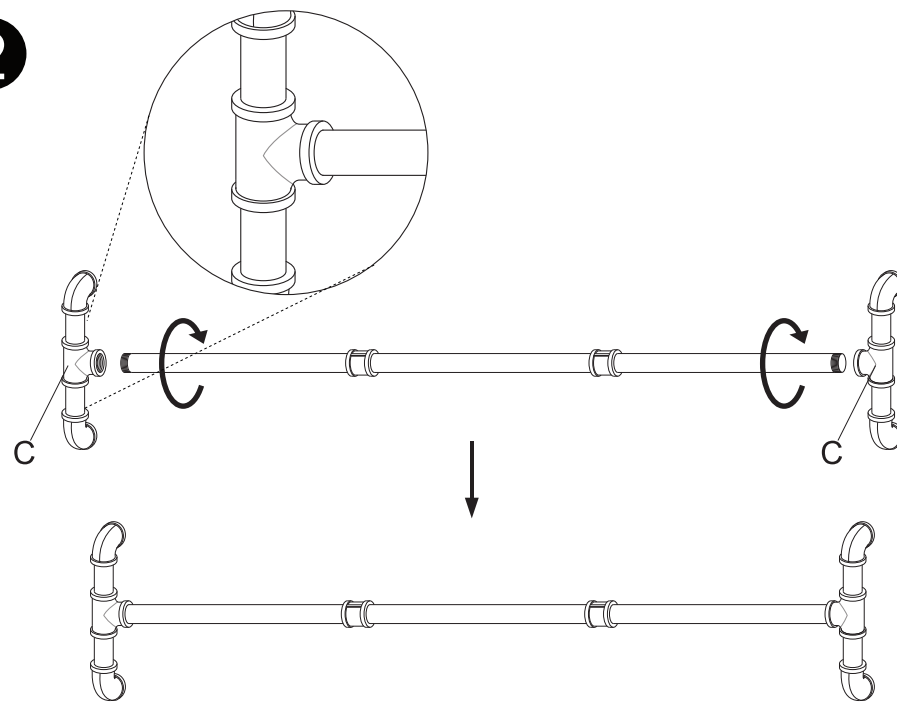

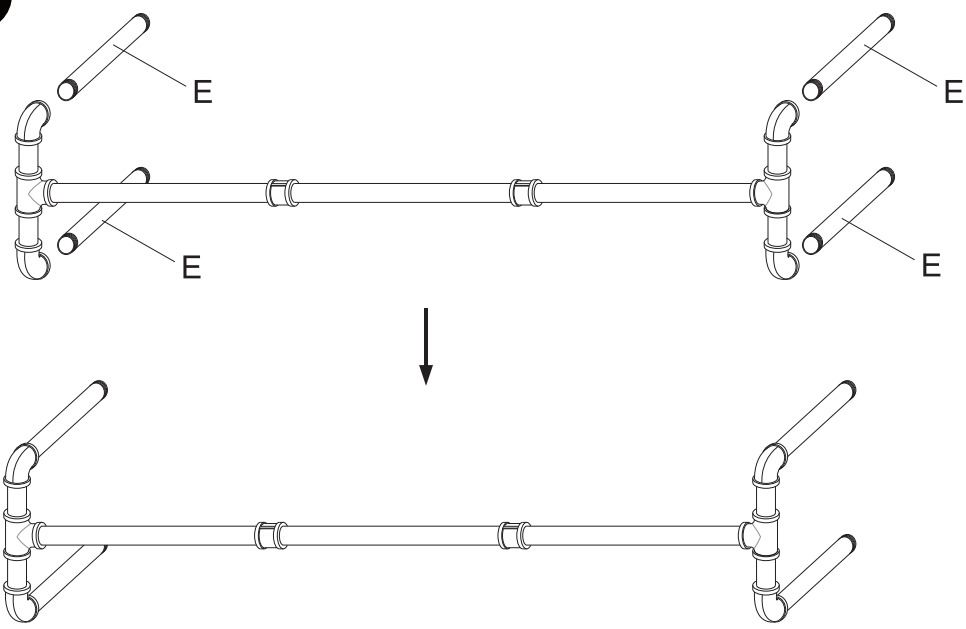

3

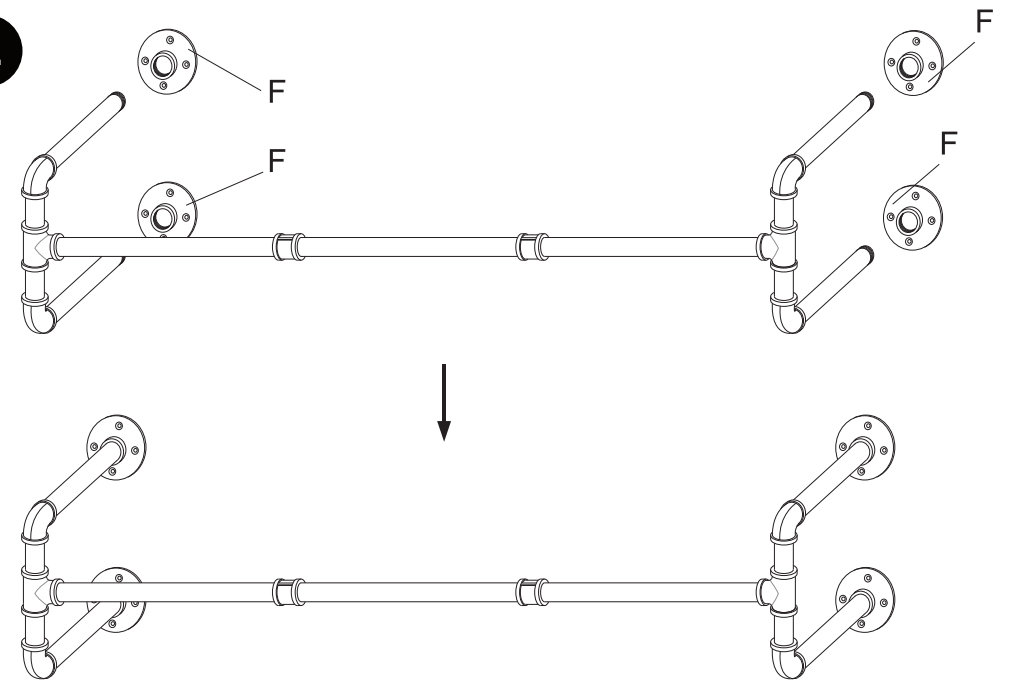

4



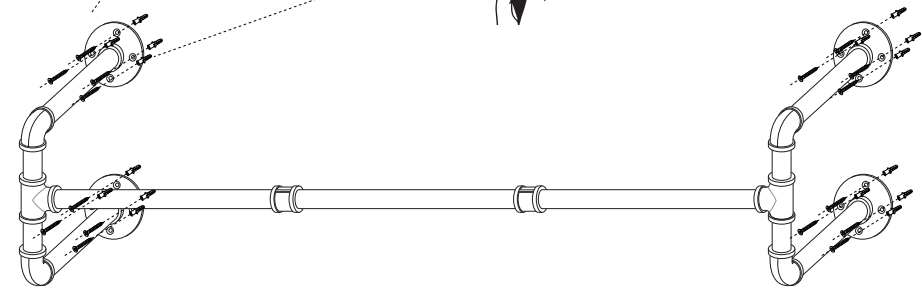
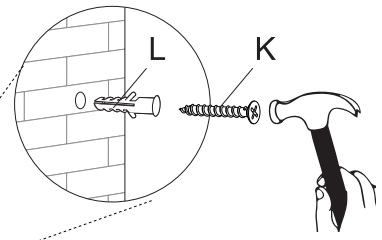

5

-  K *16
-  L *16

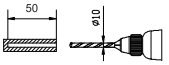
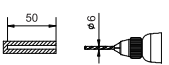

-  50 8.0
▶ Brick wall ▶ Ziegelwand ▶ Mur de briques
▶ コンクリート壁:10mm径のドリルビットを使う
-  50 9.0
▶ Wood wall ▶ Holzwandl ▶ Mur de bois
▶ 木柱壁:6mm径のドリルビットを使う

6

-  M *6
-  K *2
-  L *2

